

# DENON®

## AVR-S710W

INTEGRATED NETWORK AV RECEIVER

ENGLISH

FRANÇAIS

ESPAÑOL

# Quick Start Guide

Guide de configuration rapide / Guía de configuración rápida

## Read Me First....

Lisez-moi en premier.... / Lea esto primero....

**Please do not return this unit to the store.  
If you need help...**

**Check our AVR setup tips online**  
**Usa.denon.com/SetupTips**  
**Ca.Denon.com/SetupTips**

**Call for Assistance**  
**1-855-MY.DENON (USA) 1-855-693-3666**  
**1-800-668-0652 (Canada)**





Monday – Friday 10:00AM to 10:00PM E.S.T  
Saturday 12:00PM to 8:00PM E.S.T

# Welcome

Thank you for choosing a Denon AV receiver. This guide provides step-by-step instructions for setting up your AV receiver.

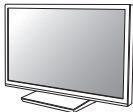
# Before You Begin

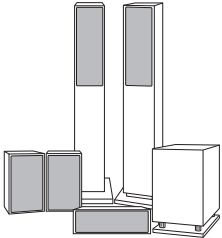
## Required for Setup

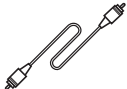
 TV	 Speaker cables	 Speaker systems
 HDMI cable	 Subwoofer cable	



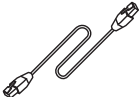
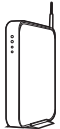









## Optional

 LAN cable	or	 Wi-Fi router
------------------------------------------------------------------------------------------------	----	-----------------------------------------------------------------------------------------------------



- When connecting this unit to a device that is compatible with the Deep Color, 4K and ARC functions, use a “High Speed HDMI cable with Ethernet” that displays the HDMI logo.
- These drawings are for illustrative purposes only and may not represent the actual product(s).

# What's In the Box

Quick Start Guide		FM indoor antenna	
Safety Instructions		AM loop antenna	
Notes on radio		Sound calibration microphone	
Warranty (for North America model only)		Sound calibration microphone stand	
Cable labels		Remote control unit	
Receiver		R03/AAA batteries	



The supplied Sound calibration microphone stand is convenient for use when performing Speaker Calibration. Using your own tripod or the supplied Sound calibration microphone stand enables settings to be automatically configured to the optimum listening environment, providing exceptionally high performance.

# Setup

There are three steps to the setup process.

**1** Installing batteries in the remote control unit

**2** Connecting the receiver

**3** Following the On-Screen Setup Assistant

**1**

**Installing batteries in the remote control unit**

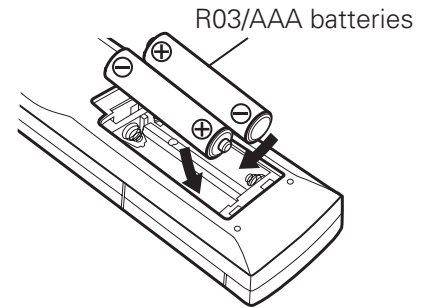
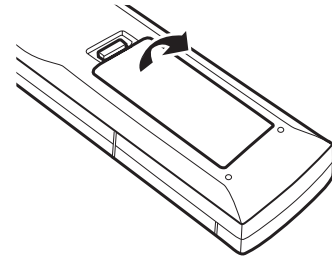

## 2 Connecting the receiver

2.1) Place the receiver near your TV and connect the power cord.

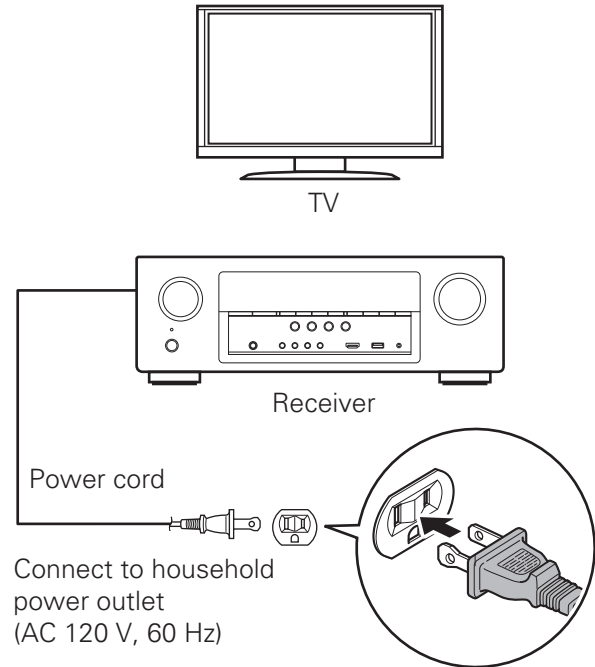

## 2.2) Connect to the network.

### Wired LAN

When connecting cables (wired connection), connect a LAN cable between your receiver and your network router.

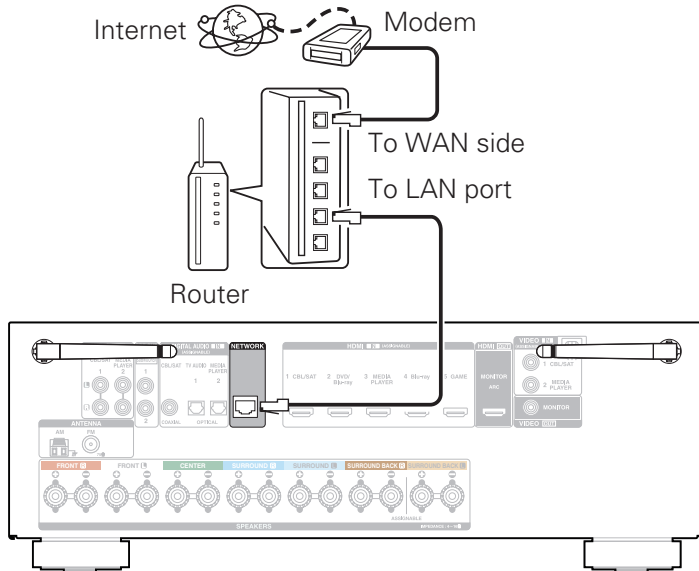

### Wireless LAN

When using a wireless connection (Wi-Fi), rotate the antennas upward.

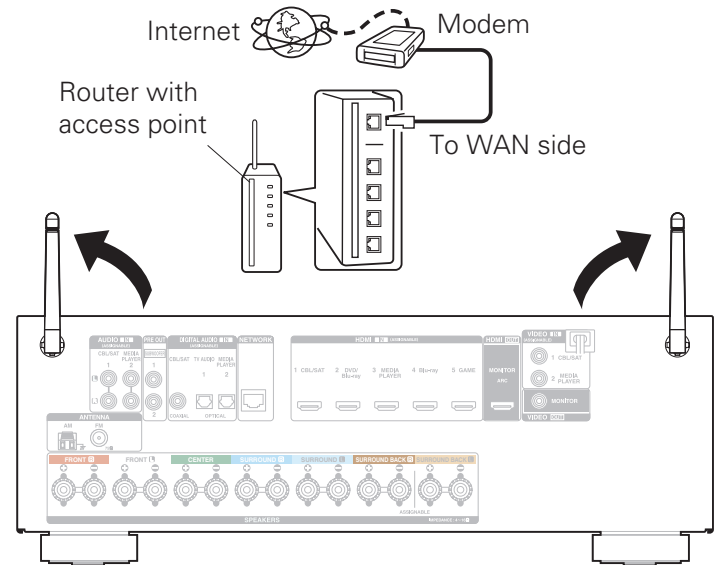

## 2.3) Connect the receiver to your TV with an HDMI cable.

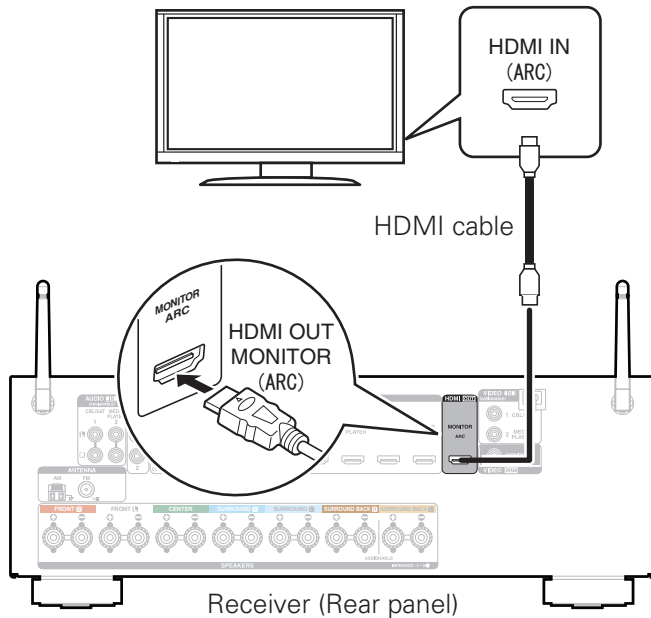

### ARC (Audio Return Channel) :

If your TV supports ARC, your TV can send audio back to the AV receiver when you are using your TV's built-in video sources (TV tuner, Smart TV streaming services, etc...) ARC requires that you enable HDMI CEC on your TV. Please refer to your TV's Owner's Manual for instructions on how to setup HDMI CEC. Note that some TV manufacturers use other names for the HDMI CEC function.

## 2.4) Turn on the TV.

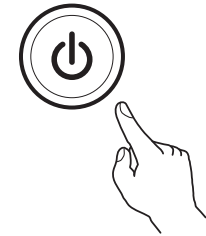
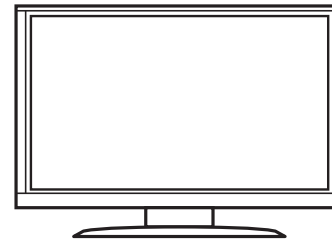

TV remote control unit

## 2.5) Select the appropriate HDMI input on your TV.

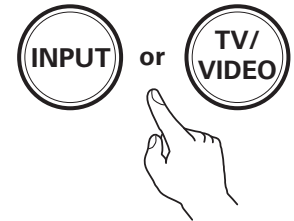

TV remote control unit

## 2.6) Turn on the receiver.

- Press  to turn on the receiver.

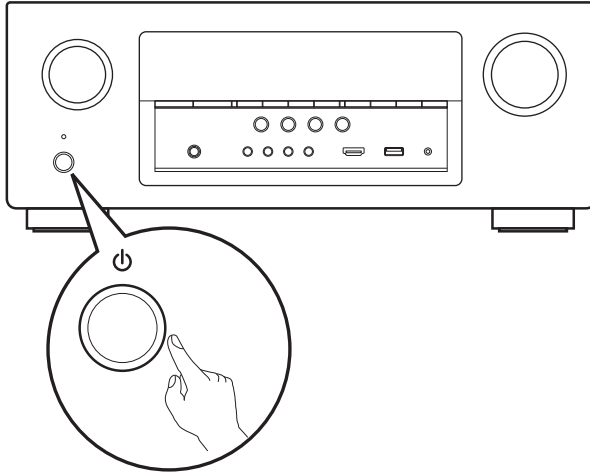

## 2.7) Verify the connection.

- Verify that you can see this screen on your TV.

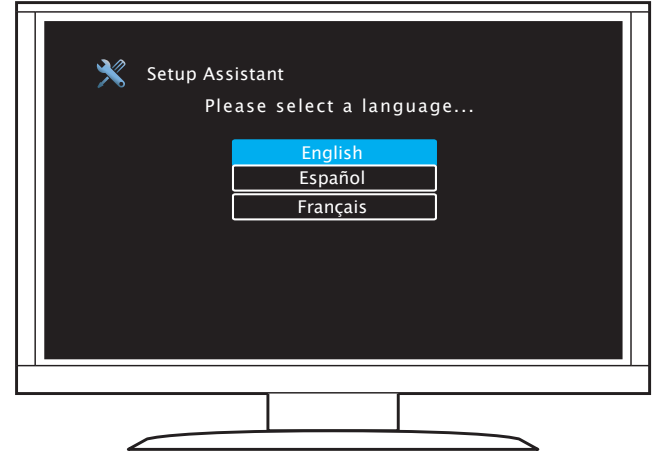

If this screen is not displayed, please go back and retry the steps again in the recommended sequence.



### 3 Following the On-Screen Setup Assistant

The Setup Assistant will walk you through connecting and configuring your speakers and components to your Denon receiver. Please use the remote control and follow the on-screen instructions.

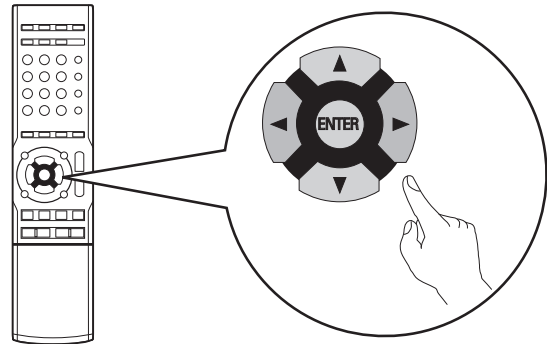
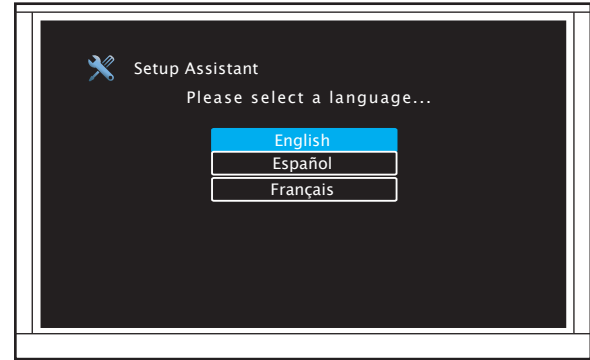

# Owner's Manual

- For more information, visit [www.denon.com](http://www.denon.com)
- Refer to the Online Manual for other functions information and operation procedure details.  
[manuals.denon.com/AVRS710W/NA/EN/](http://manuals.denon.com/AVRS710W/NA/EN/)



Online Manual

A screenshot of the Denon website's online manual page. The page has a dark blue header with the 'DENON' logo on the left, a language dropdown set to 'English', a home icon, a search icon, and a 'Contents' link. A left sidebar contains a navigation menu with items: Overview, Connections, Playback, Settings, Tips, and Appendix, each with a downward arrow. Below the menu is a 'PDF Download' button with a PDF icon. The main content area features the title 'WEB Manual' in large blue font, followed by 'INTEGRATED NETWORK AV RECEIVER' and 'AVR-S710W' in bold black font. Below the text is a photograph of the black AVR-S710W receiver. At the bottom of the page, there is a small copyright notice: 'INTEGRATED NETWORK AV RECEIVER Copyright © 2015 DENON Holdings Inc. All Rights Reserved.'



**DENON®**

[www.denon.com](http://www.denon.com)

Printed in China 5411 11276 00AD  
Copyright © 2015 D&M Holdings Inc. All Rights Reserved.