

SERIES **6**
673

LED TV

Installation manual

imagine the possibilities

Thank you for purchasing this Samsung product.
To receive more complete service, please register
your product at

www.samsung.com/register

Model _____ Serial No. _____

SAMSUNG

Figures and illustrations in this User Manual are provided for reference only and may differ from actual product appearance. Product design and specifications may be changed without notice.

Introduction

This TV B2B (Business to Business) model is designed for the hospital or the other hospitality businesses, supports a variety of special functions, and lets you limit some user (guest) controls.

Operational Modes

This TV has two modes : Interactive and Stand-alone mode.

- Interactive mode : In this mode, the TV communicates with and is fully or partially controlled by a connected Set Back Box (SBB) or Set Top Box (STB) provided by a hospitality SI (System Integration) vendor. When the TV is initially plugged in, it sends a command that attempts to identify the SSB or STB connected to it. If the TV identifies the SBB or STB and the SBB or STB identifies the TV, the TV gives full control to the SBB or STB.
- Stand-alone mode : In this mode, this TV works alone without an external SBB or the STB.

The TV has a Hospitality Menu that lets you easily set its various hospitality functions. Please see pages 13 to 16.

The Menu also lets you activate or de-activate some TV and hospitality functions so you can create your optimal hospitality configuration.

Still image warning

Avoid displaying still images (such as jpeg picture files) or still image elements (such as TV channel logos, panorama or 4:3 format images, stock or news bars or crawls) on the screen. Displaying still pictures continually can cause uneven screen wear, which will affect image quality. To reduce the chance that this effect will occur, please follow the recommendations below:

- Avoid displaying the same TV channel for long periods.
- Always try to display a full screen image.
- Reduce brightness and contrast to help to prevent the occurrence of after-images.
- Frequently use all TV features designed to reduce image retention and screen burn-in. Refer to the proper user manual section for details.

Ensuring Proper Ventilation

When you install the TV, maintain the distances shown below between the TV and other objects (walls, cabinet sides, etc.) to ensure proper ventilation. Failing to do so may result in a fire or problems with the TV caused by an increase in its internal temperature.

 When using a stand or wall-mount, use parts provided by Samsung Electronics only.

 Using parts provided by another manufacturer may cause difficulties with the product or result in injury caused by the product falling.

Installation with a wall-mount.

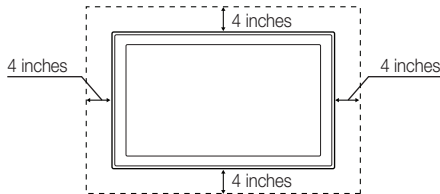

Additional Information

 The appearance of the TV and its accessories may differ from the illustrations in this manual, depending on the TV.

 Be careful when you touch the TV if it is on or has been on for a period of time. Some parts can be hot.

Contents

- Introduction 2
- Operational Modes 2
- Still image warning 2
- Ensuring Proper Ventilation 2
- Additional Information 2
- Accessories 4
- Using the TV's Controller 4
- The Connection Panel..... 5
- Connecting the TV to an SBB or STB 6
- **Connecting a Pillow Speaker (NC673 Models only) 7**
- Connecting the RJP (Remote Jack Pack)..... 10
- Setting the Hotel Option Data 12
- Installing the Wall Mount 34
- Specifications 35
- Dimensions 36



Accessories

- Please make sure the following items are included with your LED TV. If any items are missing, contact your dealer.
- The items' color and shape may vary, depending on the model.

List of Parts

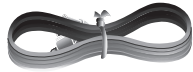

- Power Cord

- Safety Guide / Quick Setup Guide
(Not available in all locations)

Using the TV's Controller

The TV's Controller, a small joy stick like button on the rear right side of the TV, lets you control the TV without the remote control.

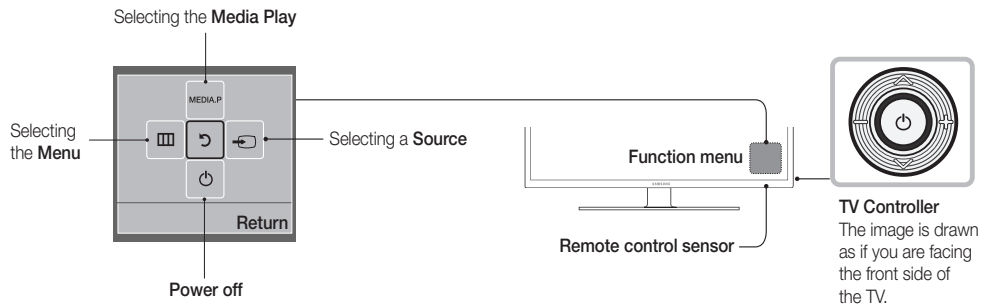

- The product color and shape may vary depending on the model.
- To exit the menu, press the Controller for more than 1 second.
- When selecting a function by moving the controller backwards/forwards/left/right, be sure not to press up on the controller. If you press up first, it will not operate correctly.

Standby mode

Your TV enters Standby mode when you turn it off and continues to consume a small amount of electric power. To be safe and to decrease power consumption, do not leave your TV in standby mode for long periods of time (when you are away on vacation, for example). It is best to unplug the power cord.

The Connection Panel

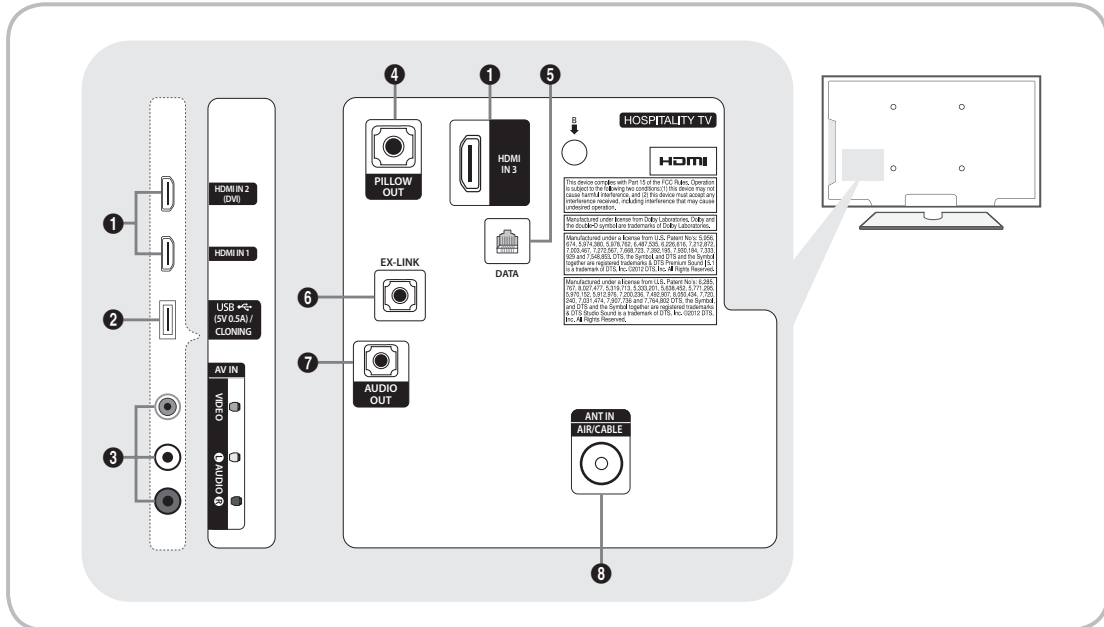

✎ Whenever you connect an external device to your TV, make sure that power on the TV and the device is turned off.

✎ When connecting an external device, match the color of the connection terminal to the cable.

1 **HDMI IN 1, 2(DVI), 3** : Connects to the HDMI jack of a device with an HDMI output.

✎ No sound connection is needed for an HDMI to HDMI connection. HDMI connections carry both audio and video.

✎ Use the **HDMI IN 2(DVI)** jack for a DVI connection to an external device. Use a DVI to HDMI cable or DVI-HDMI adapter (DVI to HDMI) for the video connection.

2 **USB / CLONING**

- Connector for software upgrades and Media Play, etc.
- Service connection.

3 **VIDEO / L-AUDIO-R**

- Connect a VIDEO cable to an appropriate external A/V device such as a VCR, DVD, or Camcorder.
- Connect audio cables to L-AUDIO-R on your TV and the other ends to corresponding audio out jacks on the AV device.

4 **PILLOW OUT** : Connect the pillow speaker. Refer to page 12 for more information.

5 **DATA**

- Used to support data communication between the TV and the external SBB or STB.
- Connects using an RJ-12 type of plug.

6 **EX-LINK** : Connect this jack to the jack on the optional RJP (Remote Jack Pack). This will allow you to connect external devices (Camcorder, PC, DVD players etc.) easily.

7 **AUDIO OUT**: Connects to the audio input jacks on an Amplifier/Home Theater.

8 **ANT IN(AIR/CABLE)**

- To view television channels correctly, the TV must receive a signal from one of the following sources:
- An outdoor antenna / A cable television system / A satellite receiver.

Connecting the TV to an SBB or STB

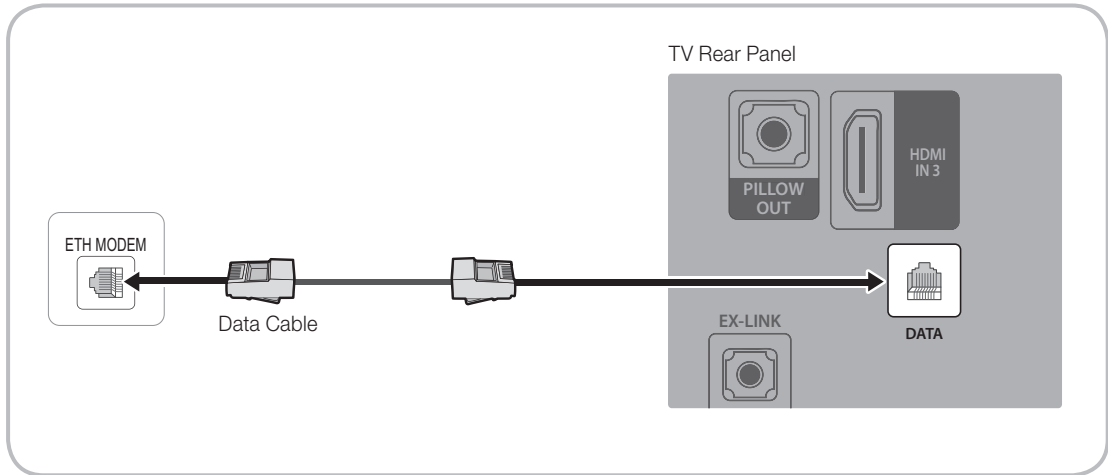

1. Connect the **DATA** jack of the TV to the **ETH MODEM** jack of the STB (SBB) with the Data cable.

 The "ETH MODEM" jack name that you connect the Data Cable to may differ depending on the SBB or STB type.

Connecting a Pillow Speaker (NC673 Models only)

You can connect a pillow speaker to the TV in the hospital using a jumper cable. The speaker functions as a remote control and speaker. (Jumper cable not provide)

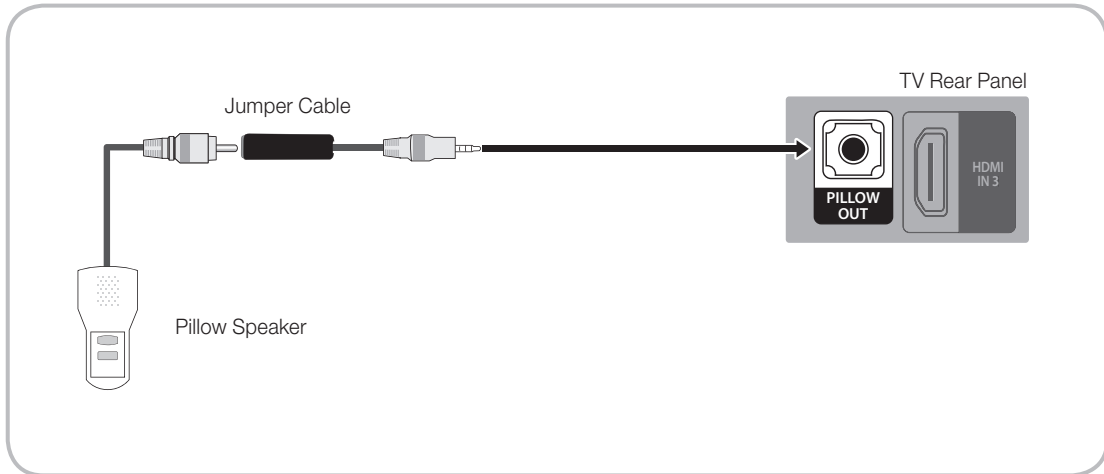

1. Connect the pillow speaker jumper cable (cable sold separately) from the television's PILLOW SPEAKER Port to the pillow speaker jack on the wall behind the television.

Pillow Speaker Jack Specifications

- Output jack: RCA type
- Input jumper pin: 1/8" 3-conductor stereo phone pin.
- Signal specifications: Tip-Audio, Ring-Data/Channel change, Sleeve-Common

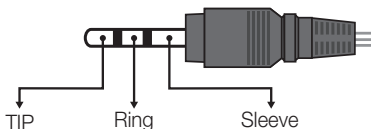

How to Use the Pillow Speaker

- Analog type speaker: The pillow speaker has one key.
 - Power On: press the key when the TV is in standby mode.
 - Channel Up: press the key when the speaker is on.
 - Power Off: press and hold the key for more than 3 seconds when the speaker is on.
 - An Analog type speaker always works regardless of the Pillow Speaker Type value set in the Hospital mode setup menu.
- Digital type speaker: The TV supports the Samsung, Philips, or Zenith code.
 - This speaker is only compatible with a specified IR code. You can change the code in the Hospital mode setup menu.
 - The TV gives priority to the Samsung remote control over the pillow speaker's wired remote control.
 - Option : Channel Menu Display.

Pillow Sound Control

Speaker Selection Menu	TV Speaker	Pillow Speaker
TV Speaker	Sound	Sound
External Speaker	No Sound	Sound

List of SI Vendors and Compatible Data Cables Supplied with the TV

- Confirm you are using the correct data cable for your vendor. Refer to the code label on the data cables.
- Contact your nearest dealer or your SI Vendor to buy the data cable not included in the TV.

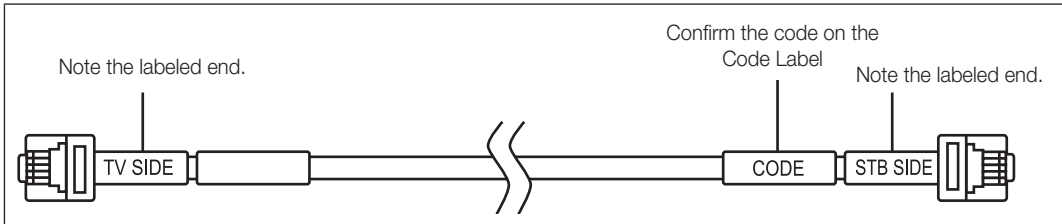

SI Vendor	Cable code	Pin assign	Remark
Samsung OCC Enseo Guest-Tek	BN39-00865B	<p><CON A></p> <p>6: IR 5: GND 4: Tx 3: NC 2: Rx 1: NC</p> <p>CON A CON B</p> <p>6 •-----• 1 5 •-----• 2 2 •-----• 5 4 •-----• 6</p> <p><CON B></p> <p>1: IR 2: GND 3: NC 4: NC 5: Tx 6: Rx</p>	
NXTV	BN39-01011B	<p><CON A></p> <p>6: IR 5: GND 4: Tx 3: NC 2: Rx 1: NC</p> <p>CON A CON B</p> <p>6 •-----• 6 5 •-----• 5 2 •-----• 2 4 •-----• 4</p> <p><CON B></p> <p>1: NC 2: Tx 3: NC 4: Rx 5: GND 6: IR</p>	
nStreams	BN39-01110A	<p><CON A></p> <p>6: IR 5: GND 4: Tx 3: NC 2: Rx 1: NC</p> <p>CON A CON B</p> <p>6 •-----• 3 5 •-----• 4 2 •-----• 1 4 •-----• 5</p> <p><CON B></p> <p>1: Tx 2: NC 3: IR 4: GND 5: Rx 6: NC 7: NC 8: NC</p>	
MTI	BN39-01011C	<p><CON A></p> <p>6: IR 5: GND 4: Tx 3: NC 2: Rx 1: CLK</p> <p>CON A CON B</p> <p>6 •-----• 1 5 •-----• 2 4 •-----• 3 3 •-----• 4 2 •-----• 5 1 •-----• 6</p> <p><CON B></p> <p>1: IR 2: GND 3: Rx 4: NC 5: Tx 6: CLK</p>	

Connecting the Audio Output to an Audio Amplifier

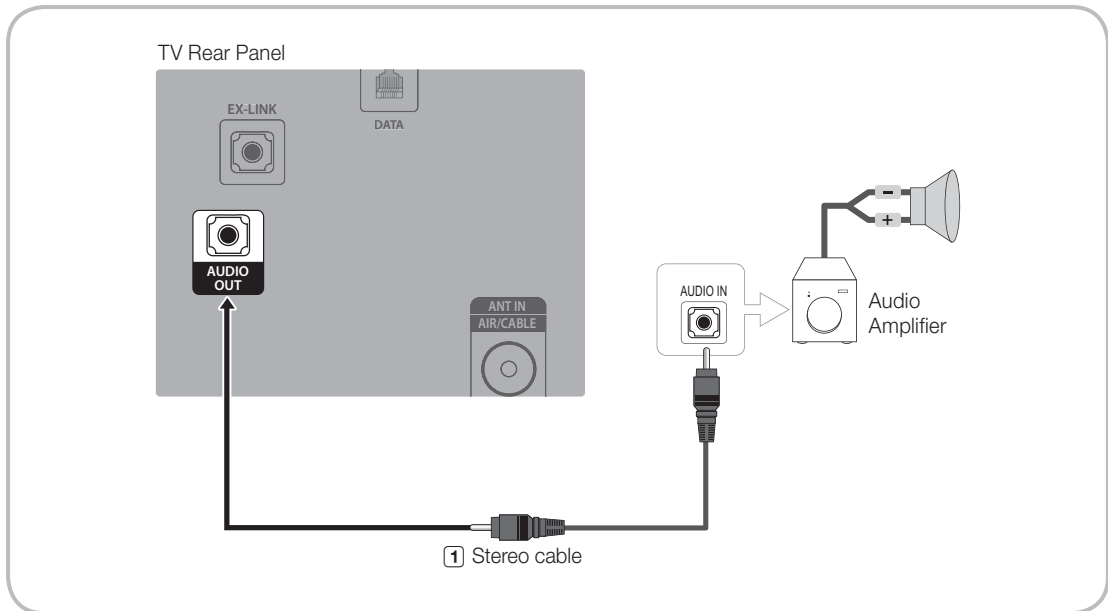

1. Connect the AUDIO OUT port of the TV to the Audio In port of an audio amplifier with a stereo cable. (Stereo cable not provide)

Connecting the RJP (Remote Jack Pack)

Connect the input jacks on the TV to the RJP. The RJP lets guests connect audio and video sources to the TV.

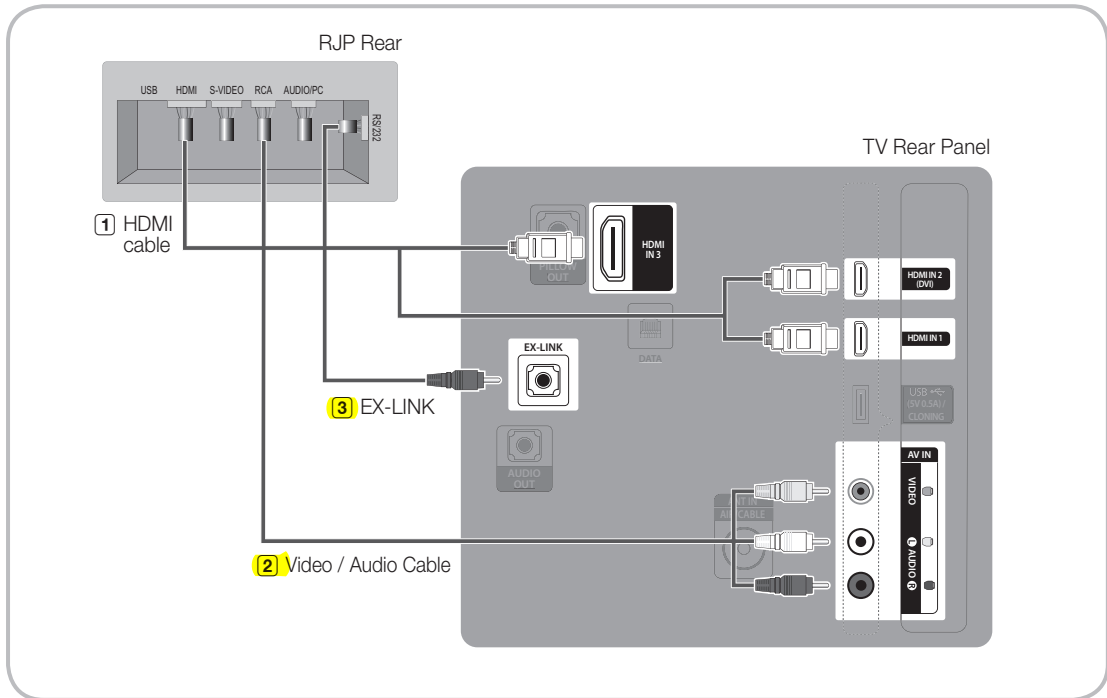

1. Connect one of the HDMI IN ports of the TV to the HDMI port of the RJP.
2. Connect the AV IN VIDEO/L-AUDIO-R ports of the TV to the RCA port of the RJP.
3. Connect the EX-LINK port of the TV to the RS/232 port of the RJP.

 This Samsung TV is compatible with the TeleAdapt TA-7610 RJP only.

- **RJP (Remote Jack Pack)** : The RJP is a hardware module that has different Audio Video inputs (AV, Audio, PC and HDMI) and corresponding outputs. The corresponding outputs are connected from the RJP to the TV. The RJP communicates with the TV via RS232. The RJP communicates with the TV by sending messages regarding Active/Inactive sources.
 - A group of hospital menu items let you assign numbered priorities to the jacks of the RJP. (See page 14). 1 is the highest priority and 3 is the lowest. When a guest connects external sources to the RJP jacks, the TV will automatically switch between sources based on the priority you have assigned them in the Menu. For example, lets say AV is set to 1 and HDMI to 2. If a guest has attached a device to the HDMI jack, and then plugs a device into the AV jack, the TV automatically switches to the device plugged into the AV jack (the jack with the higher priority). Note that a guest can also switch between devices manually by pushing a button on the RJP.

 When you set up the RJP, connect the RJP to HDMI 1, 2, or 3 or AV 1 or 2.

- To reset the RJP to its factory default state, press the AV and HDMI buttons simultaneously for 10 seconds. When all button LEDs blink 5 times, the RJP reset is complete.
- The RJP will automatically turn off any LEDs after 5 minutes to avoid unnecessary light pollution in the hospital room. The LEDs that were turned off will turn on again if the guest touches any of the buttons and the 5 minute timer will restart. If the guest then touches another source button, the TV will change to the selected source and the corresponding LED will be lit.
- After an RJP Reset or a TV Power OFF/ON, it takes approximately 10 seconds to establish communications between the TV and the RJP.
- The following table shows the approximate time in seconds it takes to switch from the TV to an input source, based on assigned or default priorities.

 Scenario 1: When no inputs are connected.

Source	To Connect
AV	2 Sec
PC	0.7 Sec
HDMI	3.9 Sec

 Scenario 2 : When two or more inputs are connected to the RJP and one of the input sources is disconnected and then reconnected.

Source	Disconnect	To Connect	Total
AV	4.5 Sec	2 Sec	6.5 Sec
PC	0.7 Sec	0.7 Sec	1.4 Sec
HDMI	3.9 Sec	3.9 Sec	7.8 Sec

 An example: If the RJP has all its live sources (AV, PC, and HDMI) connected, AV has been assigned the highest priority, the RJP is in HDMI mode, and a guest removes and reconnects the AV source, the minimum time required to switch to the AV source is 6.5 seconds.

- To play audio devices (Ipdods, MP3 devices, etc.) through the RJP, you must turn Music Mode AV in the menu on. (See page 14)
- Music mode in the TA-7610 RJP is supported by the AV jack only. HDMI Music mode is available for the Guestlink RJP only.

Setting the Hotel Option Data

To let you control how the TV functions when in Hotel mode, the TV has two Hotel mode menus, the Stand-alone mode menu and the Interactive mode menu. The menu items that differ between the menus are listed below.

Menu items in the Stand-alone mode only:

- SI Vendor : SSCP
- REACH Server and its submenus.

Menu items in the Interactive mode only:

- SI Vendor: Samsung and other vendors.

All other items appear in both menus.

To access the menus, press **MUTE** → **1** → **1** → **9** → **ENTER**  on your Samsung remote.

After a menu appears, follow these general directions to navigate and change values:

- Use the Up and Down arrow buttons on the Samsung remote to move from menu item to menu item.
- Press the Enter or Left or Right arrow buttons to select a menu item. The screen displays that menu item only.
- Press the Left or Right arrow button to change a value. The Right arrow button increases numerical values. The Left arrow button decreases numerical values.
- When the screen is displaying one menu item, you can press the Up or Down arrow button to display the next or previous menu item.
- Press the **RETURN** or **MENU** button to exit the current menu item and go to a higher menu level or the Main menu.
- To exit a Hospitality mode menu, turn off the TV, and then turn it on again. Any changes you made are saved except changes to SI Vendor. For changes to SI Vendor, you must turn the TV off, wait until the Standby light glows steadily, then unplug the TV, wait for the Standby light to go off, and then plug the TV in again.

Hospitality Mode	Standalone	System
SI Vendor	OFF	
Power On		
Channel		
Menu OSD		
Clock		
Music Mode		
Remote Jack Pack		
External Source		
Pillow Speaker		
Eco Solution		
Logo/Message		
Cloning		
REACH Solution		
DRM		

Above: The Hotel mode menu.

To change menus, follow these steps:

1. Highlight the Hospitality Mode menu item in the top left corner of the menu.
2. Press the left or right arrow button on the Samsung remote. Only the Hospitality Mode menu item is displayed.
3. Press the left or right arrow button to change the Hospitality Mode item from Standalone to Interactive or from Interactive to Standalone.
4. Press the Return or Menu button on the remote. The entire menu re-appears with your selection displayed in the Hospitality Mode field.

 After you have set the values in one TV, you can clone those values to multiple TVs. See USB Cloning on page 19.

Menu Items

To Enter this menu: Press the **MUTE** → **1** → **1** → **9** → **ENTER** buttons in order.

To exit from this menu : Power Off (or Power Off and unplug if you have changed SI Vendor), and then turn on again. Any changes you made are saved.

Menu	Item	Initial Value	Description
Hospitality Mode	Hospitality Mode	Standalone	Select Hospitality mode. <ul style="list-style-type: none"> Interactive mode : TV works with an SI STB or SBB. Stand-alone mode : TV works alone, without an SI STB or SBB.
SI Vender	SI Vendor	OFF	<ul style="list-style-type: none"> Interactive mode : Samsung / OCC / MTI / Nstreams / NXTV / Enseio / Cardinal / Guestek / Seachange / EBL Stand-alone mode : OFF / Smoovie
Power On	Power On Channel	Last Saved	Set the default values that will be applied when the TV is turned on. <ul style="list-style-type: none"> User Defined : Lets you set Power On Channel and Channel Type manually. See Power On Channel and Channel Type below. Last Saved : If you select this item, when the TV is turned on, it displays the channel it was displaying when it was turned off.
	Power On Channel Num	...	When the TV is turned on, it switches automatically to this channel.
	Power On Channel Type	...	<ul style="list-style-type: none"> Select channel band : AIR (analog air band), DTV (digital air band), CATV (analog cable band), CDTV (digital cable band)
	Power On Volume	Last Saved	<ul style="list-style-type: none"> User Defined : Lets you set the Power On Volume manually. See Power On Volume below. Last Saved : When the TV is turned on, it returns to the volume that had been set when the power had been turned off.
	Power On Volume Num	...	The TV turns on with this Volume Level in Stand Alone Hospitality mode.
	Min Volume	0	The minimum Volume Level the user can set in Stand Alone Hospitality mode.
	Max Volume	100	The maximum Volume Level the user in Stand Alone Hospitality mode.
	Power On Source	TV	Select the input source the TV displays when turns on.
	Power On Option	Last Option	Determines the TV's state when power returns after a power failure or after you have unplugged the TV and then plugged it in again. <ul style="list-style-type: none"> LAST OPT : Returns to its last Power state. If it was in Stand-by, it returns to Stand-by. If it was on, it turns on. Power On : When the power returns, the TV turns on. Standby : When the power returns, the TV enters the Standby mode.
Channel	Channel Editor		The Channel Editor lets you edit the channels stored in the TV's memory. Using Channel Editor you can: <ul style="list-style-type: none"> Change the channel numbers and names, and sort the channels in your desired channel number order. Apply the video mute to channels you select. The video mute blanks out the video from a channel and outputs only the sound while displaying a speaker icon on the screen. The Channel Editor also lets you view information about each channel easily, without your having to display each channel directly.
	Channel Bank Editor		Lets you edit the channel bank that works with the item of Channel Bank Service Level or the Smoovie Remote.
	Channel Bank Service Level	Normal	Set the limitation of access to the TV channels that the patient (or the guest) can watch with this item. See page 27. <ul style="list-style-type: none"> Normal: All the channels available on the TV are accessible to the patient. Bank1/2/3: Only the channels assigned to the selected channel bank in the Channel Bank Editor are accessible to the patient. None: Channels cannot be changed by the patient. (The patient can watch only one channel set when TV is turned on.)
	Dynamic SI	OFF	<ul style="list-style-type: none"> On : Check the DTV Program channel number. (If Dynamic SI is On, it is not available to edit DTV channels in Channel Editor.) Off : Does not check the DTV Program channel number. (If Dynamic SI is Off, it is available to edit DTV channels in Channel Editor, but additional DTV channel program number update is not supported.)
	Channel Auto Store		Gives you direct, immediate access to Auto Program for searching channels.
	Mute On CC	OFF	Displays Subtitles on Mute

Menu	Item	Initial Value	Description
Menu OSD	Picture Menu Lock	OFF	Enable or disable the Picture Menu.
	Menu Display	ON	<ul style="list-style-type: none"> On : The Main Menu is displayed. Off : The Main Menu is not displayed.
	Panel Button Lock	Unlock	Turning the front panel (local key) operations on/off. <ul style="list-style-type: none"> Unlock : Unlocks all panel keys. Lock : Locks all panel keys. OnlyPower : Locks all panel keys except the Power panel key. Menu/Source : Locks the Menu and Source panel keys.
Clock	Clock Type	OFF	OFF:Close SW Clock. SW Clock:Open SW Clock .
	Local Time	Manual	Select the way to update clock data. Use clock data from a DTV channel to set the clock automatically or set the clock manually when the TV is in stand-alone mode.
	Time Channel Type	...	Use clock data from which DTV channel to set the clock
	Time Channel Num	...	DTV channel Number
Music Mode	Music Mode AV	OFF	Allows music output from an mp3/audio player connected to an AV Input Source on the TV. When on, you can hear sound from the player through the TV whether there is a video signal or not. Also mutes the video so the TV does not display a picture when a guest is playing music. The TV's backlight, however, remains on.
	Music Mode Backlight	OFF	When set to Off, the TV's backlight is turned off entirely when a guest uses the Music mode. To save energy, set to Off.
Remote Jack Pack	Priority AV	1	If the jack priority is set, the corresponding source is automatically set when a jack is inserted according to the jack priority
	Priority HDMI	2	If the jack priority is set, the corresponding source is automatically set when a jack is inserted according to the jack priority.
	AV Option	AV	Select RJP AV Source (Source selection depends on Model).
	HDMI Option	HDMI 1	Select which HDMI source of the TV is connected to the RJP jack. (HDMI1/HDMI2/HDMI3)
	HDMI Music Mode	OFF	Allows music output from an mp3/audio player connected to an HDMI Input Source. When on, you can hear sound from the player through an HDMI input of the RJP whether there is a video signal or not. (This option is only compatible with the Guest link RJP.)
External Source	USB Pop-up Screen	Default	When a USB device is connected to the TV : <ul style="list-style-type: none"> Default : A popup window appears. Automatic : Opens the USB contents menu automatically. Disable : Neither the popup window nor the menu appears.
	External Source Banner	ON	If set to On, the TV displays the External Source Banner (information) when you change the TV source to another external input, press the Info key, or turn the TV on. <ul style="list-style-type: none"> On : The External Source information is displayed on the TV screen. Off : The External Source information is not displayed on the TV screen.
	Auto Source	OFF	<ul style="list-style-type: none"> On : When an external input source is connected to the TV, the TV identifies the input source, and then automatically switches to that input source. Off : Auto Source function is Off.



Menu	Item	initial Value	Description
Pillow Speaker	Pillow Speaker Type	CZ	Select the type of Pillow Speaker. You must select the type of Pillow Speaker currently connected for it to operate properly. <ul style="list-style-type: none"> • CZ : the type of Zenith IR Code and 12V Vcc • CP : the type of Philips IR Code and 5V Vcc • CS : the type of Samsung IR Code and 12V Vcc
	Speaker Select	Main	Select the speaker where the TV sound is outputted. <ul style="list-style-type: none"> • Main : The TV sound is outputted in all of the TV speaker and Pillow Speaker. • External : The TV sound is outputted in Pillow Speaker only.
	Pillow Volume	Normal	You can control the volume level of Pillow Speaker. <ul style="list-style-type: none"> • High : The volume level of Pillow Speaker is high. • Normal : The volume level of Pillow Speaker is normal. • Low : The volume level of Pillow Speaker is low.
Eco Solution	Energy Saving	OFF	Adjusts the brightness of the TV to reduce power consumption. <ul style="list-style-type: none"> • Off: Turns off the energy saving function. • Low: Sets the TV to low energy saving mode. • Medium: Sets the TV to medium energy saving mode. • High: Sets the TV to high energy saving mode.
Logo / Message	Welcome Message	OFF	Displays a the Welcome Message for 5 seconds when the TV turns On.
	Edit Welcome Message		Edits the Welcome Message.
	Hospitality Logo	OFF	Turns the Hospitality logo feature On or Off, If On, when the TV is turned on, the Logo is displayed, before the signal from the initial source, for the amount of time set in "Logo Display Time".
	Hospitality Logo DL	...	Downloads the Hospitality logo. Hospitality logo file requirements: <ul style="list-style-type: none"> • BMP or AVI files only. • Max file size : BMP - 960 X 540. AVI - 30MB. • The file can only be named samsung.bmp or samsung.avi.
	Logo Display Time	...	Hospitality Logo Display Time (3/5/7 seconds).
Cloning	Clone TV to USB	-	Clone the current TV options to a USB memory device.
	Clone USB to TV	-	Clone the saved TV options on a USB memory device to the TV.
	Setting Auto Initialize	OFF	If you set Setting Auto Initialize to On, and the TV's power is turned off and on, the guest side menu items are restored to their cloned values. See page 30.
REACH Solution	REACH 3.0	OFF	OFF:Close REACH 3.0 ON:Open REACH 3.0
	REACH 2.0	OFF	OFF:Close REACH 2.0 ON:Open REACH 2.0
	REACH Channel	...	87:Assign a DTV channel number to carry the update REACH data. This channel number must be the same as the number set on the Reach server.
	Group ID	...	All:Select the group ID of the REACH server. (Refer to the REACH server manual for more details)
	IPG Room Type	...	You can receive up to 3 EPG information headed to the Americas according to Room Type from SI, and it displays the appropriate channel list and EPG information according to the value set on TV.For IPG Room Type, there are Default / Public / Roomtype3 within the hotel Factory Install menu, and its default value is Default.
	TICKER	...	<ul style="list-style-type: none"> • On : The TICKER content is displayed. • Off : The TICKER content is not displayed.

Menu	Item	Initial Value	Description
REACH Solution	REACH Update Time	...	Lets you set when data such as updated SW, cloning files, and S-LYNK REACH contents is downloaded from the REACH server to the TV : <ul style="list-style-type: none"> 1 hour : Every hour 2 hour : Every 2 hours 12:00 am : every 12:00 a.m. 12:00 pm : every 12:00 p.m. 2:00 pm : every 2:00 p.m.
	REACH Update Immediate	...	<ul style="list-style-type: none"> On : Whenever the TV enters standby mode (the power cord is plugged in and the power is off), the REACH data is updated on the TV. Off : The REACH data is only updated on the TV at the REACH server update time.
	Room Number	...	Setting Room Number.
	REACH 2.0 TV Sound	...	<ul style="list-style-type: none"> OFF:Close REACH 2.0 TV Sound ON:Open REACH 2.0 TV Sound
	REACH 2.0 Server Version	...	0000:Displays the current REACH data version.
DRM	DRM Mode	Pro:Idiom	Configures CAS support. Applies to only the NB673, NB677, and NB678 models. OFF : Turns off CAS support. LYNK DRM : Select to turn on S-LYNK DRM CAS support only. Pro:Idiom : Select to turn on Pro:Idiom CAS support only. LYNK DRM,PI : Select to have the TV support S-LYNK DRM CAS and Pro:Idiom CAS.
	PI AES Data	0xD279	Displays the current state of Pro:Idiom AES
	PI AES Log	OFF	PI AES Log consists of Pro:Idiom AES diagnostic register, here after referred as AESD, values. These register log will help us diagnose PI key loss issue in the field and provide solution for it.
	View PI AES Log	...	Displays Pro:Idiom AES Log OSD
System	Self Diagnosis for TV		Lets you check the state of the TV picture and sound. <ul style="list-style-type: none"> Picture Test : Use to check for picture problems. If the problem appears in the test picture, select YES, and then follow the directions on the screen. Sound Test : Use to check for sound problems. If the problem occurs during the test, select YES, and then follow the directions on the screen.
	Self Diagnosis for HTV		Lets you check the state of Pro:Idiom and its communication with the SI STB or SBB. If you have any problems with the Pro:Idiom encryption channel or the communications with the SI STB or SBB, use this diagnosis function. If Pro:Idiom DTV Channel Key Loss appears to have failed and the Pro:Idiom encryption channel has failed to play content, first check the broadcasting systems related to Pro:Idiom encryption. If your broadcasting system does not have a problem, contact Samsung Service. If STB SI Vendor Setting appears to have failed and communication with the SI STB or SBB has failed, first check your SI STB or SBB. If your SI STB or SBB does not have a problem, contact to Samsung Service
	SW Update		Lets you upgrade the TV SW with a USB memory stick. See Page 31.
	Service Pattern	OFF	Lets you check the state of the TV picture by displaying picture test patterns. Press the Menu button to turn off the test patterns and exit.
	ATV Cable AGC Gain		Lets you control the AGC gain of the analog cable channels. Don't change the default value unless problems occur.
	DTV OpenCable AGC Gain		Lets you control the AGC gain of the digital cable channels. Don't change the default value unless problems occur.
	Contact Samsung		Samsung Contac information
	TV Reset		Returns all settings on the TV to their factory defaults.

 REACH (Remote Enhanced Active Control for Hospitality) is a professional, interactive remote controller that lets you deliver TV firmware updates, cloning data, channel mapping changes, S-LYNK REACH contents, and TICKER contents through RF DTV to several hundred hospitality TVs simultaneously. The REACH functions are available only in standalone mode. The REACH Server is sold separately. Refer to the REACH server manual enclosed with the REACH server product for more operating information.

Using the Football Mode (Only Mexico have)

Soccer Mode

 MENU  → Applications → Soccer Mode → ENTER 

This mode provides optimized condition for watching sports games.

- **A (Zoom)**: Pause playback and divide the picture into 9 parts. Select a part to zoom it in. Press this button again to resume.

 If you turn the TV off while watching **Soccer Mode**, the **Soccer Mode** will be disable.

Welcome Message

The Welcome Message feature displays a custom message on the TV every time it is turned on.

- Welcome message settings are in the Hotel Option Menu.
- Set Welcome Message to ON to display the message when the TV is powered on.

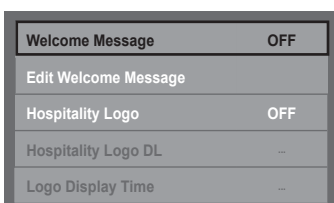

- You can make the Welcome Message up to 25 characters long and edit it in the Hotel Service menu.
- Welcome Message supports the following characters:
 -  Capital Letters from A to Z.
- You can edit the Welcome Message by using the remote's navigation, color, and Enter buttons in the **"Edit Welcome Message"** OSD (See the illustration below.)

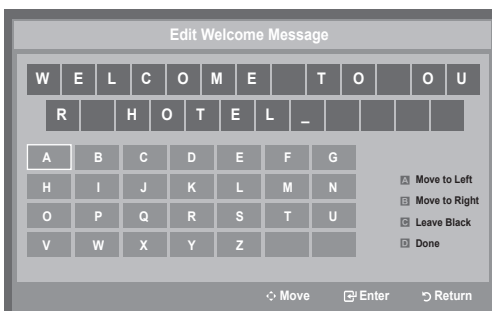

Below are the general directions for navigating and changing letters on the Edit Welcome Message screen:

- Press the **A** button on the remote to move to the left in the message.
- Press the **B** button to move to the right.
- After you have selected a position in the message, use the arrow buttons on your remote to select a letter in the alphabet below the message.
- Press **Enter** to place a letter into the position you selected.
- Press the **C** button to erase a letter in a position or enter a blank.
- Press **Return** or the **D** button to exit.

Hospitality Logo

The Hospitality Logo function displays the Hospital's picture image when the TV is initially powered on.

- Hospitality Logo settings are in the Hospital mode menus.
- The Logo Download and Logo Display Menu items are enabled when you turn the Hospitality Logo option on.
- If there is a logo image stored in memory and the Hospitality Logo option is on, the Hospitality logo is displayed when the TV is turned on.
- The Hospitality logo is not displayed when the Hospitality Logo option is off, even if the logo image has been loaded into the TV.

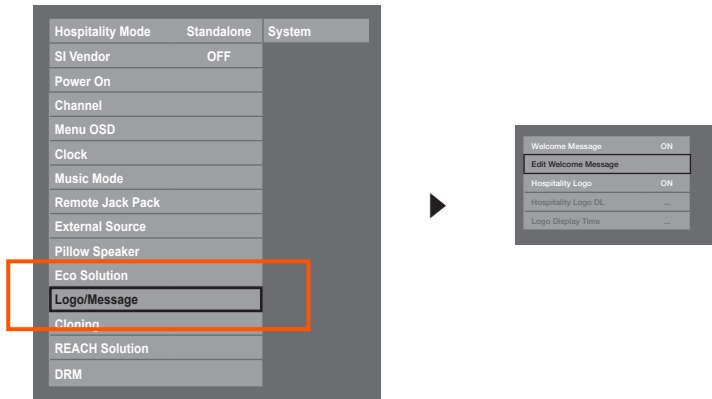



- **Hospitality Logo**
 - This option lets you choose whether the Hospitality Logo image is displayed or not.
 - The Initial value is OFF.
 - This Can be set to OFF or ON.
 - When set to ON, the Logo Download and Logo Time Display menu items become accessible.
- **Logo Download**
 - This option lets you download the logo image to the TV's memory from a USB device.
 - A wait message appears while the image is being copied to the TV.
 - A "completed" message appears when the copy operation finishes successfully.
 - The word "failed" appears if the copy operation was unsuccessful.
 - **No USB** appears if no USB device is connected.
 - **No File** appears if there is no file to copy on the USB device or the file is in the wrong format (must be a BMP or AVI file). If No File appears and there is a logo file on the USB device, check the file format.
- **Logo File Format**
 - The TV supports only BMP and AVI format.
 - The file name must be samsung.bmp or samsung.avi.
 - The maximum resolution of the BMP format is 960 x 540.
 - The maximum file size for AVI format is 30MB.
 - The TV does not change the size or scale of the image.

USB Cloning

The USB Cloning function lets you download user-configured settings (**Picture, Sound, Input, Channel, Setup, and Hospital Setup**) from one TV to a USB device, and then upload these settings from the USB device to other TV sets. This lets you create a standard array of settings and distribute that standard array to all the TVs in your facility.

- **Cloning from TV to USB:** Copies stored menu settings from a TV to a USB device.

1. Insert a USB drive into the **USB** port on the rear of the TV.
2. Enter the hotel option menu by pressing buttons in order:
MUTE → 1 → 1 → 9 → ENTER 
3. Press the **▲** or **▼** button to select **Cl one:TV to USB**, and press the **ENTER**  button.
4. the message **Clone: TV to USB** is displayed. Press the **ENTER**  button.
5. The TV displays one of the following messages:
 - **In Progress:** Copying data to USB.
 - **Completed:** Copy was successful.
 - **Failed:** Copy was not successful.
 - **No USB:** USB is not connected.



The clone folder will be labeled T-MST12AKUCB.

 The cloned values include the values on the Guest side menu (brightness, picture size, contrast, etc.) and the Hotel side menu.

Cloning from USB to TV: Copies menu settings from a USB device to a TV.

 **Shortcut:** Turn the TV off, insert the USB device, turn the TV on, and then press the **ENTER**  button for 5 seconds.

To clone data to the TV using the Hospital menu, follow these steps:

1. Turn the TV off.
2. Insert the USB drive into the USB port on the rear of the TV.
3. Turn the TV on.
4. Enter the Interactive menu by pressing these buttons in order:
MUTE → 1 → 1 → 9 → ENTER 
5. Press the **▲** or **▼** button to select “Clone USB to TV”, and then press the **ENTER**  button.
6. The message **Clone USB to TV** is displayed. Press the **ENTER**  button.
7. The TV displays one of the following messages:
 - **In Progress:** Copying data to TV.
 - **Completed:** Copy operation was successful.
 - **Failed:** Copy operation was not successful.
 - **No USB:** USB is not connected
 - **No File:** There is no file to copy on the USB device. If you get a No File message, check the folder on your USB device. The folder name should be T-NVTF6AKUCB.

 Tables that list the settings that are cloned in the Interactive and Standalone Hospital Menus begin on the next page.

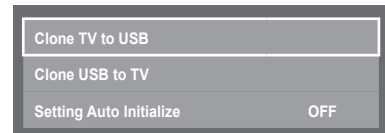
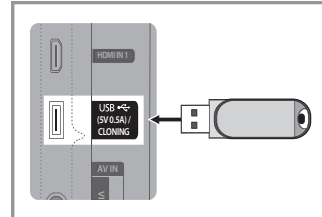

• Settings Cloned in the Hotel Menu

Category	Item	initial value	Description
Hospitality Mode	Hospitality Mode	Standalone	Select Hospitality mode. <ul style="list-style-type: none"> Interactive mode : TV works with an SI STB or SBB. Stand-alone mode : TV works alone, without an SI STB or SBB.
SI Vendor	SI Vendor	OFF	<ul style="list-style-type: none"> Interactive mode : Samsung / OCC / MTI / Nstreams / NXTV / Enseio / Cardinal / Guestek / Seachange / EBL Stand-alone mode : OFF / Smoovie
Power On	Power On Channel	Last Saved	Set the default values that will be applied when the TV is turned on. <ul style="list-style-type: none"> User Defined : Lets you set Power On Channel and Channel Type manually. See Power On Channel and Channel Type below. Last Saved : If you select this item, when the TV is turned on, it displays the channel it was displaying when it was turned off.
	Power On Channel Num	...	When the TV is turned on, it switches automatically to this channel.
	Power On Channel Type	...	<ul style="list-style-type: none"> Select channel band : AIR (analog air band), DTV (digital air band), CATV (analog cable band), CDTV (digital cable band)
	Power On Volume	Last Saved	<ul style="list-style-type: none"> User Defined : Lets you set the Power On Volume manually. See Power On Volume below. Last Saved : When the TV is turned on, it returns to the volume that had been set when the power had been turned off.
	Power On Volume Num	...	The TV turns on with this Volume Level in Stand Alone Hospitality mode.
	Min Volume	0	The minimum Volume Level the user can set in Stand Alone Hospitality mode.
	Max Volume	100	The maximum Volume Level the user in Stand Alone Hospitality mode.
	Power On Source	TV	Select the input source the TV displays when turns on.
	Power On Option	Last Option	Determines the TV's state when power returns after a power failure or after you have unplugged the TV and then plugged it in again. <ul style="list-style-type: none"> LAST OPT : Returns to its last Power state. If it was in Stand-by, it returns to Stand-by. If it was on, it turns on. Power On : When the power returns, the TV turns on. Standby : When the power returns, the TV enters the Standby mode.
Channel	Channel Editor		The Channel Editor lets you edit the channels stored in the TV's memory. Using Channel Editor you can: <ul style="list-style-type: none"> Change the channel numbers and names, and sort the channels in your desired channel number order. Apply the video mute to channels you select. The video mute blanks out the video from a channel and outputs only the sound while displaying a speaker icon on the screen. <p>The Channel Editor also lets you view information about each channel easily, without your having to display each channel directly.</p>
	Channel Bank Editor		Lets you edit the channel bank that works with the item of Channel Bank Service Level or the Smoovie Remote.
	Channel Bank Service Level	Normal	Set the limitation of access to the TV channels that the patient (or the guest) can watch with this item. See page 27. <ul style="list-style-type: none"> Normal: All the channels available on the TV are accessible to the patient. Bank1/2/3: Only the channels assigned to the selected channel bank in the Channel Bank Editor are accessible to the patient. None: Channels cannot be changed by the patient. (The patient can watch only one channel set when TV is turned on.)
	Dynamic SI	OFF	<ul style="list-style-type: none"> On : Check the DTV Program channel number. (If Dynamic SI is On, it is not available to edit DTV channels in Channel Editor.) Off : Does not check the DTV Program channel number. (If Dynamic SI is Off, it is available to edit DTV channels in Channel Editor, but additional DTV channel program number update is not supported.)
	Channel Auto Store		Gives you direct, immediate access to Auto Program for searching channels.
	Mute On CC	OFF	Displays Subtitles on Mute
Menu OSD	Picture Menu Lock	OFF	Enable or disable the Picture Menu.
	Menu Display	ON	<ul style="list-style-type: none"> On : The Main Menu is displayed. Off : The Main Menu is not displayed.
	Panel Button Lock	Unlock	Turning the front panel (local key) operations on/off. <ul style="list-style-type: none"> Unlock : Unlocks all panel keys. Lock : Locks all panel keys. OnlyPower : Locks all panel keys except the Power panel key. Menu/Source : Locks the Menu and Source panel keys.

Category	Item	initial value	Description
Clock	Clock Type	OFF	Off : No clock option of Factory menu shall work. Only Main menu. SW Clock:SW clock shall work only.
	Local Time	Manual	Select the way to update clock data. Use clock data from a DTV channel to set the clock automatically or set the clock manually when the TV is in stand-alone mode.
	Time Channel Type	...	Use clock data from which DTV channel to set the clock
	Time Channel Num	...	DTV channel Number
Music Mode	Music Mode AV	OFF	Allows music output from an mp3/audio player connected to an AV Input Source on the TV. When on, you can hear sound from the player through the TV whether there is a video signal or not. Also mutes the video so the TV does not display a picture when a guest is playing music. The TV's backlight, however, remains on.
	Music Mode Backlight	OFF	When set to Off, the TV's backlight is turned off entirely when a guest uses the Music mode. To save energy, set to Off.
Remote Jack Pack	Priority AV	1	If the jack priority is set, the corresponding source is automatically set when a jack is inserted according to the jack priority
	Priority HDMI	2	If the jack priority is set, the corresponding source is automatically set when a jack is inserted according to the jack priority.
	AV Option	AV	Select RJP AV Source (Source selection depends on Model).
	HDMI Option	HDMI 1	Select which HDMI source of the TV is connected to the RJP jack. (HDMI1/HDMI2/HDMI3)
	HDMI Music Mode	OFF	Allows music output from an mp3/audio player connected to an HDMI Input Source. When on, you can hear sound from the player through an HDMI input of the RJP whether there is a video signal or not. (This option is only compatible with the Guest link RJP.)
External Source	USB Pop-up Screen	Default	When a USB device is connected to the TV : <ul style="list-style-type: none"> • Default : a Popup window appears. • Automatic : This Enters the USB content menu automatically. • Disable : Neither the popup window nor the menu appears.
	External Source Banner	ON	If set to On, the TV displays the External Source Banner (information) when you change the TV source to another external input, press the Info key, or turn the TV on. <ul style="list-style-type: none"> • On : The External Source information is displayed on the TV screen. • Off : The External Source information is not displayed on the TV screen.
	Auto Source	OFF	<ul style="list-style-type: none"> • On : When an external input source is connected to the TV, the TV identifies the input source, and then automatically switches to that input source. • Off : Auto Source function is Off.
Pillow Speaker	Pillow Speaker Type	CZ	Select the type of Pillow Speaker. You must select the type of Pillow Speaker currently connected for it to operate properly. <ul style="list-style-type: none"> • CZ : the type of Zenith IR Code and 12V Vcc • CP : the type of Philips IR Code and 5V Vcc • CS : the type of Samsung IR Code and 12V Vcc
	Speaker Select	Main	Select the speaker where the TV sound is outputted. <ul style="list-style-type: none"> • Main : The TV sound is outputted in all of the TV speaker and Pillow Speaker. • External : The TV sound is outputted in Pillow Speaker only.
	Pillow Volume	Normal	You can control the volume level of Pillow Speaker. <ul style="list-style-type: none"> • High : The volume level of Pillow Speaker is high. • Normal : The volume level of Pillow Speaker is normal. • Low : The volume level of Pillow Speaker is low.
Eco Solution	Energy Saving	Off	Adjusts the brightness of the TV to reduce power consumption. <ul style="list-style-type: none"> • Off: Turns off the energy saving function. • Low: Sets the TV to low energy saving mode. • Medium: Sets the TV to medium energy saving mode. • High: Sets the TV to high energy saving mode.

Category	Item	initial value	Description
Logo/Message	Welcome Message	OFF	Displays a the Welcome Message for 5 seconds when the TV turns On.
	Edit Welcome Message		Edits the Welcome Message.
	Hospitality Logo	OFF	Turns the Hospitality logo feature On or Off, If On, when the TV is turned on, the Logo is displayed, before the signal from the initial source, for the amount of time set in "Logo Display Time".
	Hospitality Logo DL	...	Downloads the Hospitality logo. Hospitality logo file requirements: <ul style="list-style-type: none"> • BMP or AVI files only. • Max file size : BMP - 960 X 540. AVI - 30MB. • The file can only be named samsung.bmp or samsung.avi.
	Logo Display Time	...	Hospitality Logo Display Time (3/5/7 seconds).
Cloning	Clone TV to USB		Clone the current TV options to a USB memory device.
	Clone USB to TV		Clone the saved TV options on a USB memory device to the TV.
	Setting Auto Initialize	OFF	If you set Setting Auto Initialize to On, and the TV's power is turned off and on, the guest side menu items are restored to their cloned values. See page 30.
REACH Solution	REACH 3.0	OFF	OFF:Close REACH 3.0 ON:Open REACH 3.0"
	REACH 2.0	OFF	OFF:Close REACH 2.0 ON:Open REACH 2.0
	REACH Channel	...	87:Assign a DTV channel number to carry the update REACH data. This channel number must be the same as the number set on the Reach server.
	Group ID	...	All:Select the group ID of the REACH server. (Refer to the REACH server manual for more details)
	IPG Room Type	...	You can receive up to 3 EPG information headed to the Americas according to Room Type from SI, and it displays the appropriate channel list and EPG information according to the value set on TV.For IPG Room Type, there are Default / Public / Roomtype3 within the hotel Factory Install menu, and its default value is Default.
	TICKER	...	<ul style="list-style-type: none"> • On : The TICKER content is displayed. • Off : The TICKER content is not displayed.
	REACH Update Time	...	Lets you set when data such as updated SW, cloning files, and S-LYNK REACH contents is downloaded from the REACH server to the TV : <ul style="list-style-type: none"> • 1hour : Every hour • 2hour : Every 2 hours • 12:00 am : every 12:00 a.m. • 12:00 pm : every 12:00 p.m. • 2:00 pm : every 2:00 p.m.
	REACH Update Immediate	...	<ul style="list-style-type: none"> • On : Whenever the TV enters standby mode (the power cord is plugged in and the power is off), the REACH data is updated on the TV. • Off : The REACH data is only updated on the TV at the REACH server update time.
	Room Number	...	Setting Room Number.
	REACH 2.0 TV Sound	...	<ul style="list-style-type: none"> • OFF:Close REACH 2.0 TV Sound • ON:Open REACH 2.0 TV Sound
REACH 2.0 Server Version	...	0000:Displays the current REACH data version.	
DRM	DRM Mode	Pro:idiom	Configures CAS support. Applies to only the NB673, NB677, and NB678 models. OFF : Turns off CAS support. LYNK DRM : Select to turn on S-LYNK DRM CAS support only. Pro:idiom : Select to turn on Pro:Idim CAS support only. LYNK DRM,PI : Select to have the TV support S-LYNK DRM CAS and Pro:Idiom CAS.
	PI AES Data	0xD279	Displays the current state of Pro:Idiom AES
	PI AES Log	OFF	PI AES Log consists of Pro:Idiom AES diagnostic register, here after referred as AESD, values. These register log will help us diagnose PI key loss issue in the field and provide solution for it.
	View PI AES Log	...	Displays Pro:Idiom AES Log OSD

Category	Item	initial value	Description
System	Self Diagnosis for TV		Lets you check the state of the TV picture and sound. <ul style="list-style-type: none"> Picture Test : Use to check for picture problems. If the problem appears in the test picture, select YES, and then follow the directions on the screen. Sound Test : Use to check for sound problems. If the problem occurs during the test, select YES, and then follow the directions on the screen.
	Self Diagnosis for HTV		Lets you check the state of Pro:Idiom and its communication with the SI STB or SBB. If you have any problems with the Pro:Idiom encryption channel or the communications with the SI STB or SBB, use this diagnosis function. If Pro:Idiom DTV Channel Key Loss appears to have failed and the Pro:Idim encryption channel has failed to play content, first check the broadcasting systems related to Pro:Idiom encryption. If your broadcasting system does not have a problem, contact Samsung Service. If STB SI Vendor Setting appears to have failed and communication with the SI STB or SBB has failed, first check your SI STB or SBB. If your SI STB or SBB does not have a problem, contact to Samsung Service
	SW Update		Lets you upgrade the TV SW with a USB memory stick. See Page 31.
	Service Pattern	OFF	Lets you check the state of the TV picture by displaying picture test patterns. Press the Menu button to turn off the test patterns and exit.
	ATV Cable AGC Gain		Lets you control the AGC gain of the analog cable channels. Don't change the default value unless problems occur.
	DTV OpenCable AGC Gain		Lets you control the AGC gain of the digital cable channels. Don't change the default value unless problems occur.
	Contact Samsung		Samsung Contac information
	TV reset		Returns all settings on the TV to their factory defaults.

Multi Code Remocon

A Multi Code Remocon is a special remote which is designed to control multiple TVs.

This is useful where there is more than one TV in a location.

You can control up to 10 TVs with a different ID code of each remote with no conflicts between the TVs. ID numbers are displayed on each TV's OSD.

The Initial ID code for each TV is "0".

- You can set and reset the ID code in Analog TV mode or PC mode. (Not available in DTV mode.)
- You can set the ID code to any digit from 0 to 9.
- To set a TV's ID code, follow these steps:
 1. Aim the remote at the TV, and then press the **MUTE** button and the **RETURN** button simultaneously for more than 7 seconds. When you stop pressing the buttons, the TV displays the current ID in the middle of the screen and the words, "Remote control code is set to x. If you want to change the Remote control code, enter the digit you want to change."
 2. Press the number on the remote you want to assign to the TV. The TV displays the following words:
"Remote control code is changed to x."
 The TV will display the OSD until you press the Exit button.

See the example below.

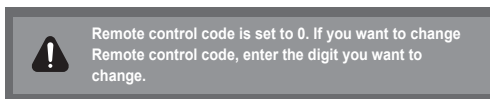

Example: After you see the message above, if you press 1, the TV and Remote will be set to ID code 1. The TV then displays the following message: "Remote control code is changed to 1"

The TV can then only be controlled by a remote which has the same ID code (1).

- To reset the ID code, press the **MUTE** button and the **EXIT** button simultaneously for more than 7 seconds. When you stop pressing the buttons, the ID codes of the TV and Remote are reset to "0". "Remote control code is set to 0." appears on the TV.

Setting Auto Initialize

When you clone settings from one TV to another, you clone both the guest side menu and hospital side menu settings: Picture, Sound, Input, Channel, Setup, and Hospital Setup. This lets you set nearly all the menu values on your hospitality TVs to the same, standard settings. If you allow guests access to the guest side menus, for example - the Picture menu - they can change the settings in those menus so they are no longer standard. If you set the Setting Auto Initialize function to On, the TV automatically restores (initializes) any guest-side menu values to the cloned, standard values when the TV is turned off and then turned on again. Note that Setting Auto Initialize works on cloned guest side menu values only. Settings which have not been cloned are ignored.

The table below lists the settings that are restored to their cloned values when you set the Setting Auto Initialize function to On.

Menu	Menu Item	Menu	Menu Item	
Picture Menu	Picture Mode	Sound Menu	Sound Mode	
	Backlight		Sound Effect	
	Contrast		DTS TruSurround	
	Brightness		DTS TruDialog	
	Sharpness		Equalizer	
	Color		Speaker Settings	
	Tint (G/R)		Speaker Select	
	Picture Size		Auto Volume	
	Picture Size		Reset Sound	
	Position		System	
	PIP		Menu Language	
	Advanced Settings		Time	
	Dynamic Contrast		Clock	
	Black Tone		Sleep Timer	
	Flesh Tone	Wake-up Time		
	RGB Only Mode	Eco Solution		
	Color Space	Energy Saving		
	White Balance	No Signal Power Off		
	Gamma	Auto Power Off		
	Motion Lighting	Auto Protection Time		
	Picture Option	Change PIN		
	Color Tone	General		
	Digital Clean View	Game Mode		
	MPEG Noise Filter	Boot Logo		
	HDMI Black Level	DivX® Video On Demand		
	Film Mode			
	Picture Off			
	Reset Picture			
			System Menu	

Hotel Plug & Play

The Hotel Plug & Play function, which automatically performs the Hotel mode selection, Country Setup, Clock Setup, and Picture Mode Setup, runs once, when power is first turned ON. Setup also runs automatically after you have executed a Service Reset.

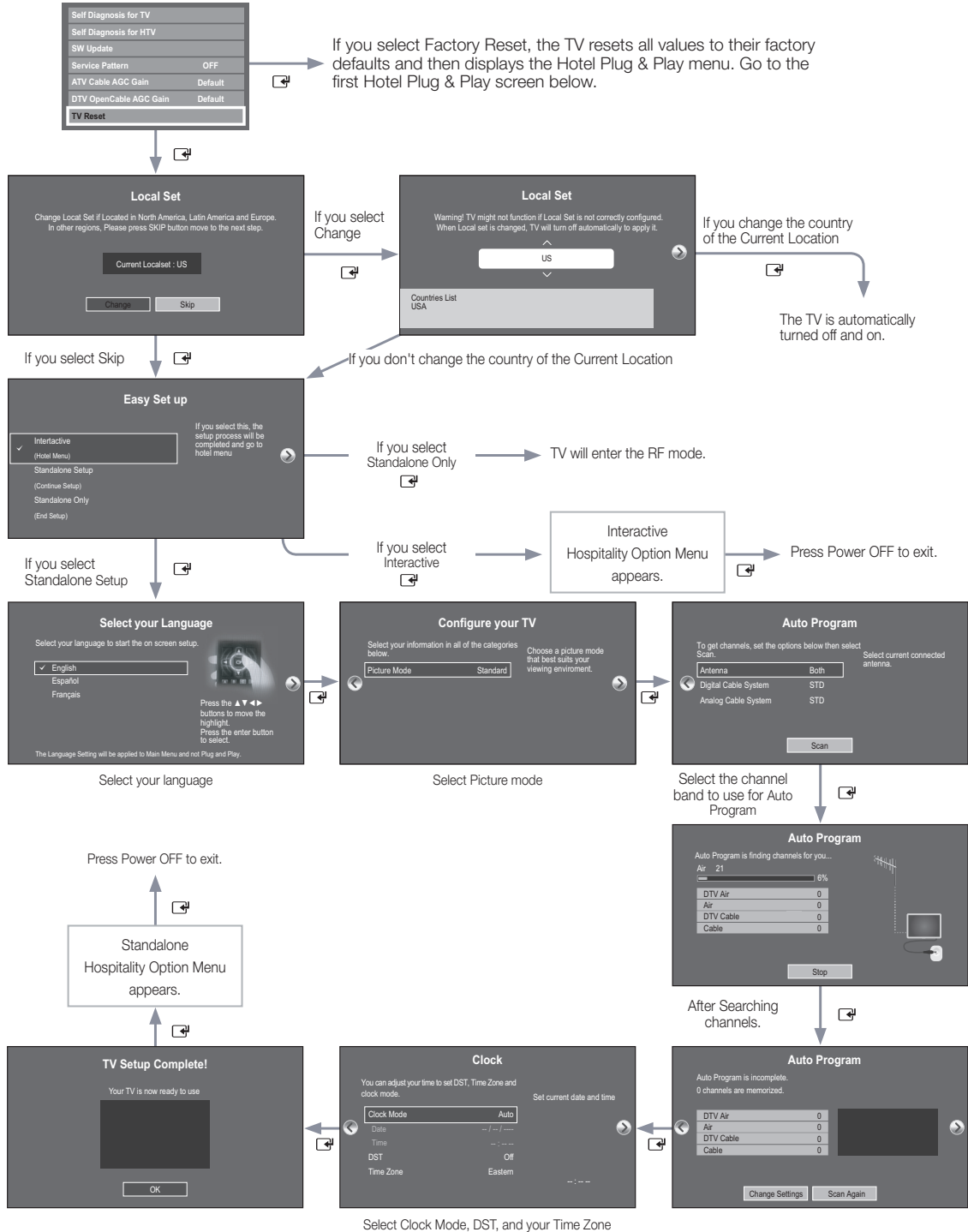

- **Hotel Plug & Play OSD**
 - Initially highlighted: Interactive
 - If you select the Standalone Only button, the Standalone hotel mode is set by default and the “Standalone mode is set” OSD appears for 3 seconds.
 - TV enters into RF mode automatically after displaying the “Standalone mode is set” OSD for 3 seconds.
 - If you select the Interactive mode, the Interactive Setup Menu is displayed. Press the power off key to exit from the Interactive menu.
 - If you select the Standalone Plug & Play mode, the “Select Menu Language” OSD appears.
- **LocalSet**
 - Initially highlighted: US
 - If you press the Enter key after selecting Change, you can change the country.
If the country is changed, the TV automatically turns off and on.
 - If you select the Interactive mode, the Interactive Setup Menu is displayed. Press the power off key to exit from the Interactive menu.
 - If you select the incorrect country, execute TV Reset again after entering the Service section of the Hotel Menu.
- **Select Menu Language OSD**
 - If you select Standalone from the “Select Hotel TV Mode” OSD, the “Select Menu Language” OSD appears.
 - Initially highlighted: English
 - Display time: OSD timeout and operation are the same as Samsung's consumer TV models.
 - If you press the Enter key, the “Select Country” OSD appears
- **Picture Mode OSD**
 - Initially highlighted: Standard.
 - The TV displays the Picture Mode OSD where you can choose the Dynamic or a Standard Picture mode.
- **Auto Search Mode OSD**
 - If you press the Enter key, the TV automatically searches for channels.
 - The OSD Display time, which starts when the Auto Store operation is completed and continues until the Auto Sort function starts, is 30 seconds.
- **Set Clock Mode, DST (Daylight saving time), and Time Zone OSD**
 - Initially highlighted:
Clock Mode : Auto, DST : Off, Time Zone : Eastern
 - If the TV will be tuned to digital broadcast channels, and these channels transmit date and time information, set the Clock Mode to Auto. The TV will set the date and time automatically.
 - If the TV will not be tuned to digital broadcast channels, set the Clock Mode to Manual, and then set the date and time on the TV manually.
 - Set DST On or Off to apply or not apply daylight saving time to the TV.
 - Select your time zone on the map that appears.

USB Software Upgrade Method

Samsung may offer upgrades to the TV's software (SW) in the future. Please contact the Samsung Hospitality Hotline at 1-866-894-0524 to receive information about downloading upgrades and using a USB drive to update the SW by connecting the USB drive containing the upgrade to the USB port located on the TV.

When the software is upgraded, video and audio settings you have made will return to their default (factory) settings. We recommend you clone the hotel settings so that you can easily reset them after the upgrade.

To upgrade the TV's software, follow these steps:

1. Insert a USB drive containing the SW upgrade into the **USB** port on the side of the TV.
2. Press the **MENU** button to display the menu.
Press the **▲** or **▼** button to select **Support**, and then press the **ENTER** button.
3. Press the **▲** or **▼** button to select **SW Upgrade**, and then press the **ENTER** button.
The message "**Scanning for USB. This may take more than 1min.**" is displayed.
4. The message "**Upgrade version XXXX to version XXXX? The system will be reset after upgrade.**" is displayed.
Press the **◀** or **▶** to select the **OK**, and then press the **ENTER** button.

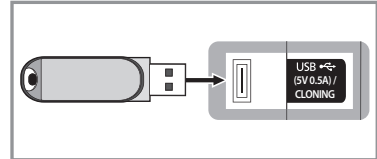

Please be careful to not disconnect the power or remove the USB drive while upgrades are being applied. The TV will turn off and turn on automatically after completing the SW upgrade. Please check the SW version after the upgrades are complete.

Channel Bank Editor

The Channel Bank Editor lets you control the channels the patient (or the guest) have access to. The Channel Bank Editor provides three Banks of channels and lets you select which channels will be available from each bank. You can control access to channels by setting the item of Channel Bank Service Level in Hospitality Option Menu.

Setting the Channel Bank Editor under Stand-alone Mode

1. Press **MUTE+1+1+9+Enter** on the remote to enter the Hotel Standalone menu.
2. Find the menu option, **"Channel Bank Editor"**.
3. Enter the **"Channel Bank Editor"**.
4. Edit each Channel Bank. Select or deselect channels in each Channel Bank.

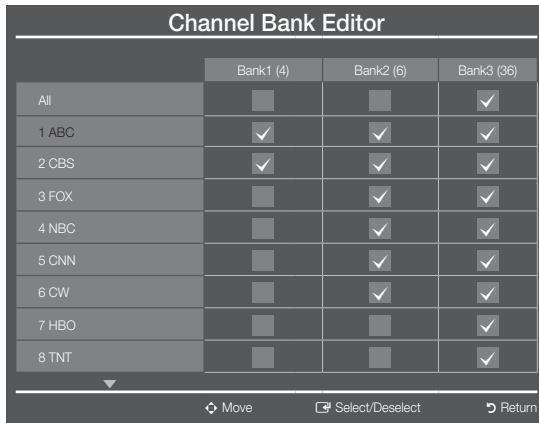

Setting Channel Bank Service Level

If you select SMOOVIE as the SI vendor, you should also use SMOOVIE remotes in your facility.

- Normal: All the channels available on the TV are accessible to the patient.
- Bank1/2/3: Only the channels assigned to the selected channel bank in the Channel Bank Editor are accessible to the patient.
- None: Channels cannot be changed by the patient. (The patient can watch only one channel set when TV is turned on.)

Channel Bank Set Up Sequence

Step	Smoovie TV Setup (Air/ Cable)	
	Only Air or Cable used	Only Air or Cable used
	If the TV starts with Hotel Plug&Play	If Hotel Plug&Play already done
1	Do a complete P&P (including Air or Cable auto tune)	Enter the Hotel menu
2	After P&P, the TV displays the Hotel menu	Select the channel type - ATV or ADTV for Air - CATV or CDTV for cable
3	Select the channel type - ATV or ADTV for Air - CATV or CDTV for cable	Select Smoovie TV in the Hotel menu
4	Select Channel Setup (Can be skipped)	Select Channel Setup
5	Select "Air" or "Cable" to auto tune (Can be skipped)	Select "Air" or "Cable" to auto tune
6	Set up channels in Channel Bank Editor	Set up Channel Bank Service Level in the Hospitality menu
7	Set up Channel Bank Service Level in the Hospitality menu	After power off & on, guests can use the TV
8	After power off & on, guests can use the TV	
9		
10		

Channel Editor

The Channel Editor lets you edit the channels stored in the TV's memory. Using Channel Editor you can:

- Change the channel numbers and names, and sort the channels in your desired channel number order.
- Apply the video mute to channels you select. The video mute blanks out the video from a channel and outputs only the sound while displaying a speaker icon on the screen.

The Channel Editor also lets you view information about each channel easily, without your having to display each channel directly.

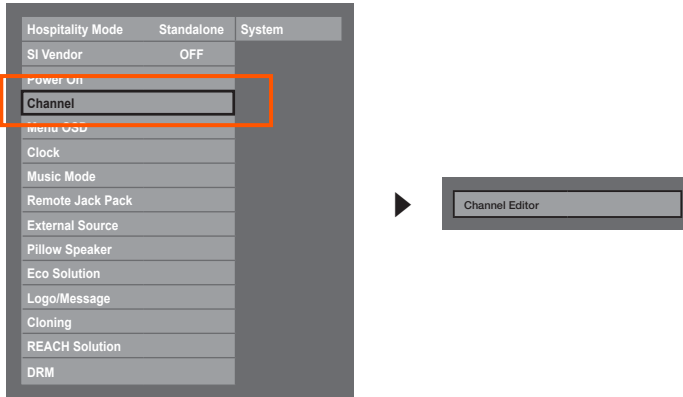

- <Depending on model and region, some menu items may not exist.>

General Steps for Using the Channel Editor in Stand-alone Mode

Step	Broad Outline
1	Run 'Channel Auto Store' in the Hotel Option Menu.
2	Enter 'Channel Editor' in the Hotel Option Menu.
3	On a piece of paper, compile a list of channels you want to have, arranged in the order you want.
4	Rearrange channels and edit channel names with the TOOLS Button based on the list you compiled.
5	Press the EXIT or RETURN Button to exit.

<For a detailed explanation of how Channel Editor works, see pages 29 through 31.>

The picture below shows a sample Channel Editor screen.

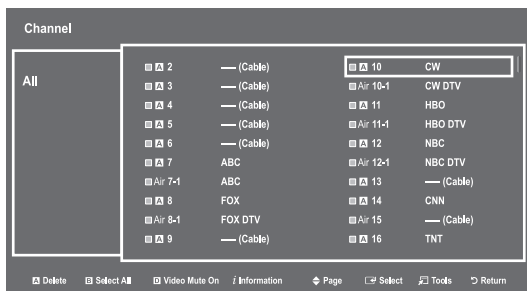

- **A** Indicates an analog channel.
- Channels without an **A** are digital channels.
 - ✎ If Dynamic SI in the Hospitality Option Menu is On, Channel Editor will display no digital channels. You must set Dynamic SI to Off before you can edit digital channels in Channel Editor.
- The guide at the bottom of the Channel Editor menu displays the remote buttons you need to press to apply Channel Editor functions.
 - 1 Using the remote's up or down arrow key, highlight the channel that you want edit.
 - To edit more than one channel, move the highlight to a channel, and then press the **ENTER** key. A check will appear in the check box next to the channel. Repeat for each channel you want to edit.
 - 2 To delete the channel or channels you selected from the channel list, press the red button on the remote.
 - To delete two or more channels simultaneously, select multiple channels in Step 1, and then press the red button on the remote.
 - 3 Press the green button on the remote to select all channels.
 - 4 To apply the video mute, press the yellow button on the remote.
 - To apply the video mute to two or more channels simultaneously, select multiple channels in Step 1, and then press the yellow button on the remote.
 - 5 To view information about a channel, including video mute set up, press the **INFO** button on the remote.
 - 6 Press the **TOOLS** button on the remote to rename a channel or change the channel number. See page 30.

Channel Editor Functions and Remote Buttons

- A** Red (**Delete**): Deletes a channel from the channel list.
- B** Green (**Select All**): Selects all channels at once.
- C** Yellow (**Deselect All**): Deselects all channels at once.
- D** Blue (**Video Mute On/Off**): Turns the **Video Mute On/Off**.
- ◆** (**Page**): Moves to next or previous page.
- i** (**Information**): Display details of the selected channel.
- ☰** (**Tools**): Displays the option menu.
- ↶** (**Return**): Returns to the previous step or exits.

When you press the **TOOLS** button, the following menu is available.

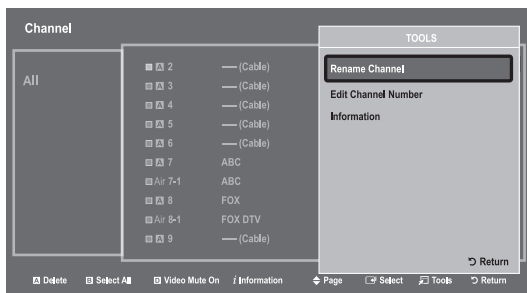

• Edit Channel Number

Use **Edit Channel Number** to change the channel number of a channel you select. To change a channel number, follow these steps:

1. Select a channel on the **Channel Edit** screen.
2. Press the **TOOLS** button on your remote.
3. Select **Edit Channel Number** in the Tools menu.
4. Use the up or down arrow keys to change the channel number.
5. Select **OK** when done, and then press the **ENTER** button.

When you change the channel number, the channel information is not updated automatically.



• Rename Channel

Use **Rename Channel** to change the name of a channel you select. To change the name of a channel, follow these steps:

1. Select a channel on the Channel Edit screen.
2. Press the **TOOLS** button on your remote.
3. Select **Rename Channel** in the Tools menu.
4. Use the on-screen keyboard that appears to enter the new name for the channel. Use the arrow buttons on your remote to select a letter or number, and then press Enter. Repeat for each letter or number you want to select.
5. When finished, select **Done** on the bottom of the screen, and then press the **ENTER** button.



• Information

Use **Information** to view information about a channel you select. To view information about a channel, follow these steps:

1. Select a channel on the Channel Edit screen.
2. Press the **TOOLS** button on your remote.
3. Select **Information** in the Tools menu.
4. Select **OK**, and then press the **ENTER** button to close the Information screen.



The external sources of this TV are displayed in the last page of the Channel Editor menu as shown in the example below. In the example, there are two external sources connected to the TV, **HDMI2(DVI)** and **AV**.

- You can assign a new analog channel to an external source by selecting the source on the last page, pressing the **TOOLS** button, selecting **Edit Channel Number**, and then using the up or down arrow button on the remote to select the channel number of the analog channel.
- If you tune to a channel after assigning the channel to an external source, you can enter the external source without opening the TV source menu.

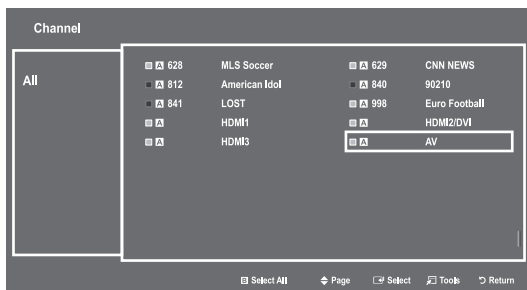

After assigning channel number 997 to the AV source.

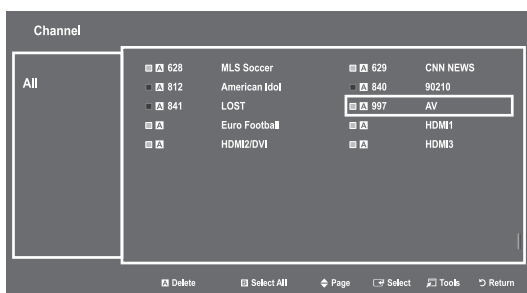

Installing the Wall Mount



Wall or Ceiling Mounting

If you mount this product on a wall, it should be mounted only as recommended by the manufacturer. Unless it is correctly mounted, the product may slide or fall, causing serious injury to a child or adult, and serious damage to the product.

Installing the Wall Mount Kit

The wall mount kit (sold separately) lets you mount the TV on the wall.

For detailed information about installing the wall mount, see the instructions provided with the wall mount. Contact a technician for assistance when installing the wall mount bracket. Samsung Electronics is not responsible for any damage to the product or injury to yourself or others if you elect to install the wall mount on your own.

To order the wall mount, contact Samsung Customer Care at 1-800-SAMSUNG (1-800-726-7864).

Wall Mount Kit Specifications (VESA)

The wall mount kit is not supplied, but sold separately.

Install your wall mount on a solid wall perpendicular to the floor. If you are attaching the wall mount to building materials other than plaster board, contact your nearest dealer. If installed on a ceiling or slanted wall, the TV may fall and cause severe personal injury.

NOTE

- Standard dimensions for wall mount kits are shown in the table below.
- Samsung wall mount kits contain a detailed installation manual. All parts necessary for assembly are provided.
- Do not use screws that do not comply with the VESA standard screw specifications.
- Do not use screws that are longer than the standard dimension or do not comply with the VESA standard screw specifications. Screws that are too long may cause damage to the inside of the TV set.
- For wall mounts that do not comply with the VESA standard screw specifications, the length of the screws may differ depending on the wall mount specifications.
- Do not fasten the screws too firmly. This may damage the product or cause the product to fall, leading to personal injury. Samsung is not liable for these kinds of accidents.
- Samsung is not liable for product damage or personal injury when a non-VESA or non-specified wall mount is used or the consumer fails to follow the product installation instructions.
- Our 57" and 63" models do not comply with VESA Specifications. Use Samsung's dedicated wall mount kit for these models.
- Do not mount the TV at more than a 15 degree tilt.
- Always have two people mount the TV onto a wall.

Product Family	TV size in inches	VESA screw hole specs (A * B) in millimeters	Standard Screw (Length* Pitch in mm)	Quantity
LED-TV	28	100 X 100	M4	4

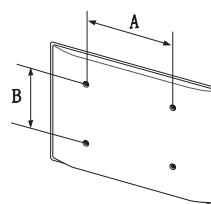

Do not install your Wall Mount Kit while your TV is turned on. It may result in personal injury due to electric shock.

Specifications

Environmental Considerations	
Operating Temperature	50°F to 104°F (10°C to 40°C)
Operating Humidity	10% to 80%, non-condensing
Storage Temperature	-4°F to 113°F (-20°C to 45°C)
Storage Humidity	5% to 95%, non-condensing
Model Name	HG28NC673
Display Resolution	1366 x 768
Screen Size (Diagonal)	28" Class (28.0" measured diagonally)
Sound (Output)	5W x 2
Dimensions (WxHxD) Body	25.3 x 15.6 x 2.5 inches (643.4 x 396.5 x 62.9 (mm))
Weight	8.6 lbs (3.9 kg)

 Design and specifications are subject to change without prior notice.

 This device is a Class B digital apparatus.

Dimensions

HG28NC673

- Front view / Side view

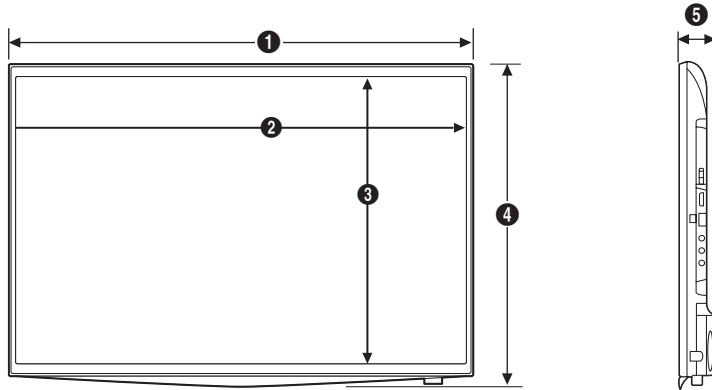

(Unit: inches)

1	2	3	4	5
25.3	24	13.7	15.6	2.5

- Jack panel detail / Rear view

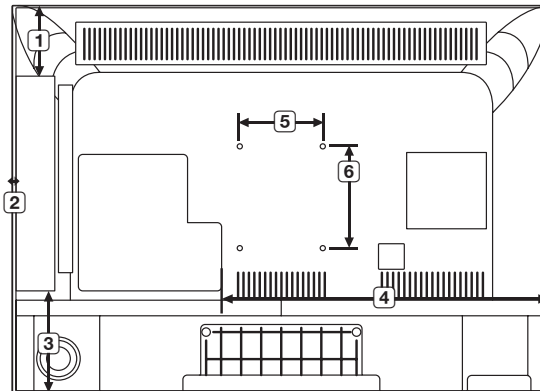

1	2	3	4	5	6
2.8	0.2	4.0	15.5	3.9	3.9

NOTE: All drawings are not necessarily to scale. Some dimensions are subject to change without prior notice. Refer to the dimensions prior to performing installation of your TV. Not responsible for typographical or printed errors.

© 2014 Samsung Electronics America, Inc



Correct Disposal of This Product (Waste Electrical & Electronic Equipment)
(Applicable in the European Union and other European countries with separate collection systems)

This marking on the product, accessories or literature indicates that the product and its electronic accessories (e.g. charger, headset, USB cable) should not be disposed of with other household waste at the end of their working life. To prevent possible harm to the environment or human health from uncontrolled waste disposal, please separate these items from other types of waste and recycle them responsibly to promote the sustainable reuse of material resources. Household users should contact either the retailer where they purchased this product, or their local government office, for details of where and how they can take these items for environmentally safe recycling. Business users should contact their supplier and check the terms and conditions of the purchase contract. This product and its electronic accessories should not be mixed with other commercial wastes for disposal.



Correct disposal of batteries in this product
(Applicable in the European Union and other European countries with separate battery return systems)

This marking on the battery, manual or packaging indicates that the batteries in this product should not be disposed of with other household waste at the end of their working life. Where marked, the chemical symbols Hg, Cd or Pb indicate that the battery contains mercury, cadmium or lead above the reference levels in EC Directive 2006/66. If batteries are not properly disposed of, these substances can cause harm to human health or the environment. To protect natural resources and to promote material reuse, please separate batteries from other types of waste and recycle them through your local, free battery return system.

Important Warranty Information Regarding Television Format Viewing

See the warranty card for more information on warranty terms.

Wide screen format LED Displays (with aspect ratios of 16:9, the ratio of the screen width to height) are primarily designed to display wide screen format full-motion video. The images displayed on them should primarily be in the wide screen, 16:9 ratio format, or expanded to fill the screen if your model offers this feature, and the images are constantly moving. Displaying stationary graphics and images on screen, such as the dark sidebars on nonexpanded standard format television video and programming, should be limited to no more than 5% of the total television viewing per week.

Additionally, viewing other stationary images and text such as stock market crawls, video game displays, station logos, web sites or computer graphics and patterns, should be limited as described above for all televisions. Displaying stationary images that exceed the above guidelines can cause uneven aging of LED displays that leave subtle, but permanent burned-in ghost images in the LED picture. To avoid this, vary the programming and images, and primarily display full screen moving images, not stationary patterns or dark bars. On LED models that offer picture sizing features, use these controls to view different formats as a full screen picture.

Be careful in the selection and duration of television formats used for viewing. Uneven LED aging as a result of format selection and use, as well as burned-in images, are not covered by your Samsung limited warranty.

- **SAMSUNG ELECTRONICS NORTH AMERICAN LIMITED WARRANTY STATEMENT**

Subject to the requirements, conditions, exclusions and limitations of the original Limited Warranty supplied with Samsung Electronics (SAMSUNG) products, and the requirements, conditions, exclusions and limitations contained herein, SAMSUNG will additionally provide Warranty Repair Service in the United States on SAMSUNG products purchased in Canada, and in Canada on SAMSUNG products purchased in the United States, for the warranty period originally specified, and to the Original Purchaser only.

The above described warranty repairs must be performed by a SAMSUNG Authorized Service Center. Along with this Statement, the Original Limited Warranty Statement and a dated Bill of Sale as Proof of Purchase must be presented to the Service Center. Transportation to and from the Service Center is the responsibility of the purchaser. Conditions covered are limited only to manufacturing defects in material or workmanship, and only those encountered in normal use of the product.

Excluded, but not limited to, are any originally specified provisions for, in-home or on-site services, minimum or maximum repair times, exchanges or replacements, accessories, options, upgrades, or consumables.

For the location of a SAMSUNG Authorized Service Center, please call toll-free:

- In the United States : 1-866-894-0524

- In Canada : 1-800-213-8513

Disconnecting Device Instructions

Worded: "To disconnect the apparatus from the mains, the plug must be pulled out from the mains socket, therefore the mains plug shall be readily operable" or equivalent.

Outdoor Use Marking - UL

Worded: "WARNING - To Prevent damage which may result in fire or electric shock hazard, do not expose this appliance to rain or moisture" or equivalent.

Wet Location Marking - c-UL

Worded: "Apparatus shall not be exposed to dripping or splashing" and "Do not place a vessel containing water on this apparatus as this can result in a risk of fire or electric shock" or equivalent.

NOTE TO CABLE TV INSTALLER

This reminder is provided to call the cable TV system installer's attention to Article 820–40 of the National Electric Code (U.S.A.). The code provides guidelines for proper grounding and, in particular, specifies that the cable ground shall be connected to the grounding system of the building, as close to the point of the cable entry as practical.

MAINTENANCE AND SERVICING

Never remove the back cover of the TV; this can expose you to high voltage and other hazards. If the TV does not operate properly, unplug it and call an authorized service center.

CLEANING AND DISINFECTING

Clean the exterior of this television by removing dust with a lint-free cloth.

CAUTION: To avoid damage to the surface of the television, do not use abrasive or chemical cleaning agents.



RAIN AND MOISTURE

WARNING: To avoid the hazards of fire or electrical shock, DO NOT expose this television to rain or moisture.



OXYGEN ENVIRONMENT

WARNING: Do not use in any oxygen tent or oxygen chamber.
Such use may cause a fire hazard.



WET LOCATION

Apparatus shall not be exposed to dripping or splashing and no objects filled with liquids, such as vases, shall be placed on the apparatus.

SERVICE INSTRUCTIONS

CAUTION: These servicing instructions are for use by qualified service personnel only.

To reduce the risk of electric shock, do not perform any servicing other than contained in the operating instructions unless you are qualified to do so. For 120 volt applications, use only a UL-Listed detachable power cord with NEMA configuration 5–15P type (parallel blades) plug cap. For 240 volt applications, use only a UL-Listed detachable power supply cord with NEMA configuration 6–15P type (tandem blades) plug cap.



Contact SAMSUNG WORLD WIDE

If you have any questions or comments relating to Samsung products, please contact the SAMSUNG customer care center.

Country	Customer Care Center ☎	Web Site	Address
CANADA	1-800-SAMSUNG (726-7864)	www.samsung.com/ca/support (English) www.samsung.com/ca_fr/support (French)	Samsung Electronics Canada Inc. 2050 Derry Road West, Mississauga, Ontario L5N 0B9 Canada
U.S.A	1-800-SAMSUNG (726-7864)	www.samsung.com/us/support	Samsung Electronics America, Inc. 85 Challenger Road Ridgefield Park, NJ 07660