

HW-E450

Crystal Surround Air Track (Active Speaker System) user manual

imagine the possibilities

Thank you for purchasing this Samsung product.
To receive more complete service,
please register your product at
www.samsung.com/register



features

HDMI

HDMI transmits video and audio signals simultaneously, and provides a clearer picture.

The unit is also equipped with the ARC function which lets you listen to sound from your TV via an HDMI cable through the Crystal Surround Air Track. This function is only available if you connect the unit to an ARC compliant TV.

3D Depth Sound

The 3D sound feature adds depth and spaciousness to your listening experience.

Wireless Subwoofer

Samsung's wireless module does away with cables running between the main unit and the subwoofer. Instead, the subwoofer connects to a compact wireless module that communicates with the main unit.

Special Sound mode

You can select from 7 different sound modes - MUSIC, NEWS, DRAMA, CINEMA, SPORTS, GAME, and OFF (Original Sound) - depending on the type of content you want to enjoy.

Multi-function Remote Control

The supplied remote control can be used to control the TV connected to this unit. (Works only for Samsung TVs)

The remote control has a TV hotkey that enables you to perform various operations with the simple press of a button.

Active Speaker System

This unit features an Active Speaker System that provides high sound quality in a single slim unit.

This unit does not require any satellite loudspeakers or speaker cabling, which are normally associated with conventional surround sound systems.

USB Host support

You can connect and play music files from external USB storage devices such as MP3 players, USB flash memory, etc. using the Air Track's USB HOST function.

Bluetooth Function

You can use a Bluetooth device to enjoy music with high quality stereo sound, all without wires!

LICENSE



Dolby and the double-d symbol are registered trademarks of dolby laboratories.



Manufactured under license under U.S. Patent Nos: 5,956,674; 5,974,380; 6,487,535 & other U.S. and worldwide patents issued & pending. DTS, the Symbol, & DTS and the Symbol together are registered trademarks & DTS 2.0 Channel is a trademark of DTS, Inc. Product includes software. © DTS, Inc. All Rights Reserved.

HDMI



HDMI, the HDMI Logo, and High-Definition Multimedia Interface are trademarks or registered trademarks of HDMI Licensing LLC in the United States and other countries.

- To send inquiries and requests regarding open sources, contact Samsung via Email (oss.request@samsung.com).
- This product uses some software programs which are distributed under the Independent JPEG Group.

safety information

SAFETY WARNINGS

TO REDUCE THE RISK OF ELECTRIC SHOCK, DO NOT REMOVE THE COVER(OR BACK). NO USER-SERVICEABLE PARTS ARE INSIDE. REFER SERVICING TO QUALIFIED SERVICE PERSONNEL.

	<div style="border: 1px solid black; padding: 5px; text-align: center;"> CAUTION RISK OF ELECTRIC SHOCK DO NOT OPEN </div>	
<p>The lightning flash and Arrowhead within Triangle Is a warning sign alerting you of dangerous voltage inside the product</p>	<p>CAUTION: TO REDUCE THE RISK OF ELECTRIC SHOCK, DO NOT REMOVE COVER (OR BACK) NO USER SERVICEABLE PARTS INSIDE. REFER SERVICING TO QUALIFIED SERVICE PERSONNEL.</p>	<p>The explanation point within the triangle is a warning sign alerting you of important instructions accompanying the product.</p>

WARNING

- To reduce the risk of fire or electric shock, do not expose this appliance to rain or moisture.
- To prevent injury, this apparatus must be securely attached to the floor/wall in accordance with the installation instructions.

CAUTION

- Do not expose this apparatus to dripping or splashing. Do not put objects filled with liquids, such as vases on the apparatus.
- To turn this apparatus off completely, you must pull the power plug out of the wall socket. Consequently, the power plug must be easily and readily accessible at all times.

This product satisfies FCC regulations when shielded cables and connectors are used to connect the unit to other equipment. To prevent electromagnetic interference with electric appliances, such as radios and televisions, use shielded cables and connectors for connections.

FCC NOTE (for U.S.A):

This equipment has been tested and found to comply with the limits for a Class B digital device, pursuant to Part 15 of the FCC Rules. These limits are designed to provide reasonable protection against harmful interference in a residential installation.

This equipment generates, uses and can radiate radio frequency energy and, if not installed and used in accordance with the instructions, may cause harmful interference to radio communications. However, there is no guarantee that interference will not occur in a particular installation.

If this equipment does cause harmful interference to radio or television reception, which can be determined by turning the equipment off and on, the user is encouraged to try to correct the interference by one or more of the following measures:

- Reorient or relocate the receiving antenna.
- Increase the separation between the equipment and receiver.
- Connect the equipment to an outlet that is on a different circuit than the radio or TV.
- Consult the dealer or an experienced radio/TV technician for help.

Caution : FCC regulations state that any unauthorized changes or modifications to this equipment may void the user's authority to operate it.

Important Safety Instructions

Read these operating instructions carefully before using the unit. Follow all the safety instructions listed below. Keep these operating instructions handy for future reference.

- | | |
|---|--|
| <ol style="list-style-type: none"> 1) Read these instructions. 2) Keep these Instructions. 3) Heed all warnings. 4) Follow all instructions. 5) Do not use this apparatus near water. 6) Clean only with dry cloth. 7) Do not block any ventilation openings. Install in accordance with the manufacturer's instructions. 8) Do not install near any heat sources such as radiators, heat registers, stoves, or other apparatus (including amplifiers) that produce heat. 9) Do not defeat the safety purpose of the polarized or grounding-type plug. A polarized plug has two blades with one wider than the other. A grounding type plug has two blades and a third grounding prong. The wide blade or the third prong are provided for your safety. If the provided plug does not fit into your outlet, consult an electrician for replacement of the obsolete outlet. | <ol style="list-style-type: none"> 10) Protect the power cord from being walked on or pinched particularly at plugs, convenience receptacles, and the point where they exit from the apparatus. 11) Only use attachment/accessories specified by the manufacturer. 12) Use only with the cart, stand, tripod, bracket, or table specified by the manufacturer, or sold with the apparatus. When a cart is used, use caution when moving the cart/apparatus combination to avoid injury from tip-over. 13) Unplug this apparatus during lightning storms or when unused for long periods of time. 14) Refer all servicing to qualified service personnel. Servicing is required when the apparatus has been damaged in any way, such as power-supply cord or plug is damaged, liquid has been spilled or objects have fallen into the apparatus, the apparatus has been exposed to rain or moisture, does not operate normally, or has been dropped. |
|---|--|



PRECAUTIONS

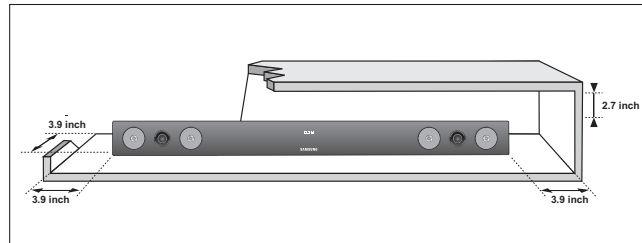

Ensure that the AC power supply in your house complies with the power requirements listed on the identification sticker located on the back of your product. Install your product horizontally, on a suitable base (furniture), with enough space around it for ventilation (3–4 inches). Make sure the ventilation slots are not covered. Do not place the unit on amplifiers or other equipment which may become hot. This unit is designed for continuous use. To fully turn off the unit, disconnect the AC plug from the wall outlet. Unplug the unit if you intend to leave it unused for a long period of time.

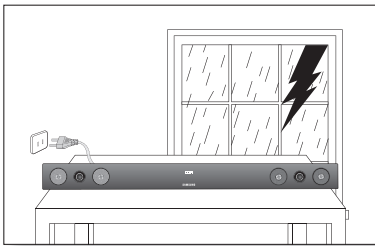

During thunderstorms, disconnect the AC plug from the wall outlet. Voltage peaks due to lightning could damage the unit.

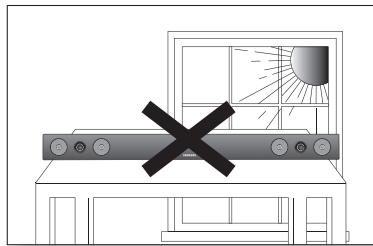

Do not expose the unit to direct sunlight or other heat sources. This could lead to overheating and malfunction of the unit.

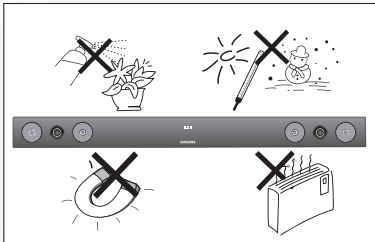

Protect the product from moisture (i.e. vases), and excess heat (e.g. fireplace) or equipment creating strong magnetic or electric fields. Disconnect the power cable from the AC supply if the unit malfunctions. Your product is not intended for industrial use. Use of this product is for personal use only.

Condensation may occur if your product has been stored in cold temperatures. If transporting the unit during the winter, wait approximately 2 hours until the unit has reached room temperature before using.

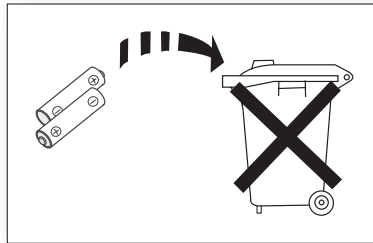

The batteries used with this product contain chemicals that are harmful to the environment.

Do not dispose of batteries in the general household trash.

contents

ENG



FEATURES	2	Features
	2	License
SAFETY INFORMATION	3	Safety warnings
	4	Precautions
GETTING STARTED	6	Before reading the user's manual
	6	What's included
DESCRIPTIONS	7	Front/Rear Panel
REMOTE CONTROL	9	Tour of the remote control
CONNECTIONS	10	Installing the wall mount
	11	Connecting the wireless subwoofer
	12	Installing toroidal ferrite to hdmi in/out
	12	Installing ferrite core to Audio/USB cable
	13	Connecting the Crystal Surround Air Track
FUNCTIONS	15	Basic functions
	16	Advanced functions
	22	Software upgrade
TROUBLESHOOTING	23	Troubleshooting
APPENDIX	24	Specifications

getting started

BEFORE READING THE USER'S MANUAL

Note the following terms before reading the user manual.

Icons used in this manual

Icon	Term	Definition
	Caution	Indicates a situation where a function does not operate or settings may be canceled.
	Note	Indicates tips or instructions on the page that help each function operate.

Safety Instructions and Troubleshooting

- 1) Be sure to be familiar with the Safety Instructions before using this product. (See page 3)
- 2) If a problem occurs, check Troubleshooting. (See page 23)







Copyright

©2012 Samsung Electronics Co.,Ltd.

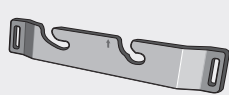
All rights reserved; no part or whole of this user's manual may be reproduced or copied without the prior written permission of Samsung Electronics Co.,Ltd.

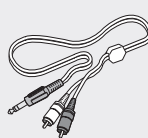
WHAT'S INCLUDED

Check for the supplied accessories shown below.

		
Remote Control / Batteries (AAA size) (AH59-02434A/ 4301-000116)	Bracket-Wall Mount (AH61-02952A)	User Manual (AH68-02431A)
	(For HDMI cable 1EA)  (Large)  (Small) (For Audio cable 1EA) (For USB cable 1EA)	
Audio Cable (AH39-01077A)	Toroidal Ferrite Core (Large : 3301-000144) (Small : 3301-001068)	USB Cable (AH39-01178A)



- The appearance of the accessories may differ slightly from the illustrations above.
- Use the dedicated USB cable to connect external USB devices to the unit.

descriptions

ENG

FRONT/REAR PANEL

DESCRIPTION

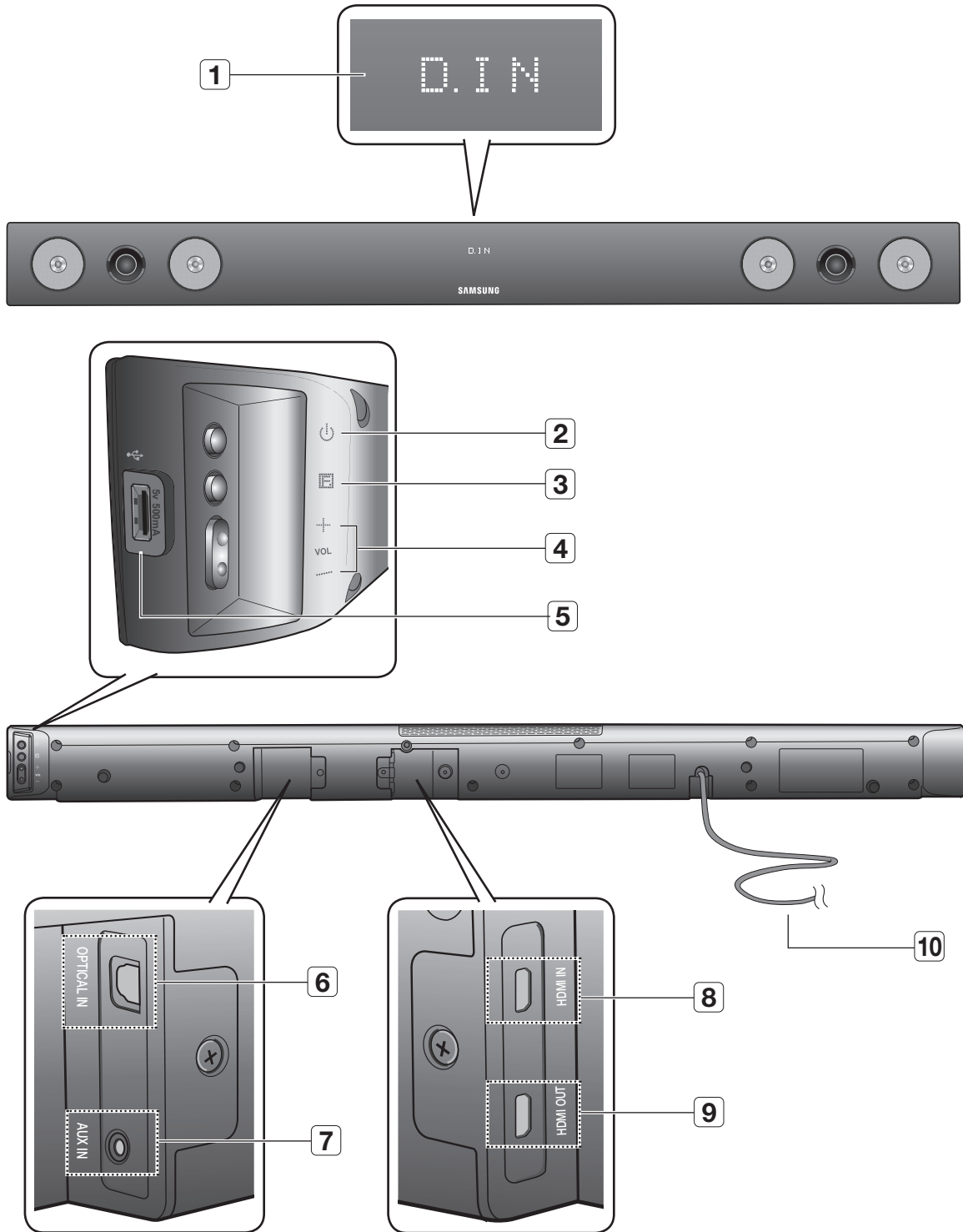

1	DISPLAY	Displays the current mode.
2	POWER BUTTON	Turns the Crystal Surround Air Track on and off.
3	FUNCTIONS BUTTON	Selects the DIGITAL, AUX, HDMI, BT, USB input.
4	VOLUME +/-	Controls the volume level.
5	USB PORT	Connect here and play files from external USB storage devices such as MP3 players.
6	OPTICAL IN	Connect to the digital (optical) output of an external device.
7	AUX IN	Connect to the Analog output of an external device.
8	HDMI IN JACK	Receives digital video and audio signals simultaneously using an HDMI cable.
9	HDMI OUT JACK	Outputs digital video and audio signals simultaneously using an HDMI cable.
10	POWER SUPPLY CABLE	Plug the power supply cable into the AC wall outlet.



- When you turn on the power of this unit, there will be a 4 to 5 second delay before it produces sound.



- When disconnecting the power cable from the wall outlet, hold the plug. Do not pull the cable.
- Do not connect this unit or other components to an AC outlet until all connections between components are complete.

remote control

ENG

TOUR OF THE REMOTE CONTROL

POWER BUTTON

Turns the Crystal Surround Air Track on and off.

SAT SOURCE

Press to select a connected SAT source. (SAT:Surround Air Track)

SOUND EFFECT

Selects the Sound Effect: (MUSIC, NEWS, DRAMA, CINEMA, SPORTS, GAME, OFF (Original Sound))

SAT MUTE

Mutes the sound from the unit. Press again to restore the sound to the previous volume level.

VOLUME

Adjusts the volume level of the unit.

REPEAT

Select Repeat File, All, Random.

DRC, DIMMER

You can use this function to enjoy Dolby Digital sound when watching movies at low volume at night (Standard, MAX, MIN). You can control the brightness of the Display.

CONTROL BUTTON

Play, pause or stop playing a Music file, or search for the Music file next or back.

TV SOURCE

Press to select a connected TV's video source.

TV PRE-CH

Moves to the previous TV channel

TV MUTE

Mutes the sound from the TV. Press again to restore the sound to the previous volume level.



TV POWER BUTTON

Turns your Samsung TV on and off.

Anynet+

Anynet+ is a function that enables you to control other Samsung Devices with your Samsung TV's remote control.

SPEAKER

This button allows you to choose to listen to audio from the Air track or your TV. (This function supports the via an HDMI cable.)

SMART VOLUME, 3D SOUND

Regulates and stabilizes the volume level against a drastic volume change. This feature adds depth and spaciousness to the sound.

S/W LEVEL, AUDIO SYNC

Adjusts the Subwoofer level. Used to help sync video to audio when connected to a digital TV.

AUTO POWER

Synchronizes the Air Track to Optical connection via the Optical jack so it turns on automatically when you turn on your TV.

TV INFO

Display current TV status.

TV CHANNEL, TV VOLUME

Switches between the available TV channels. Adjusts the TV volume level.

TV EXIT

Exits TV (functions same as the EXIT button of the TV remote control)



- SAT stands for Surround Air Track, which is a Samsung's proprietary name.
- The remote control can operate TVs made by SAMSUNG only.
- Depending on the TV you are using, you may not be able to operate your TV with this remote control. If you can't, operate the TV using the TV's remote control.

Installing batteries in the Remote Control

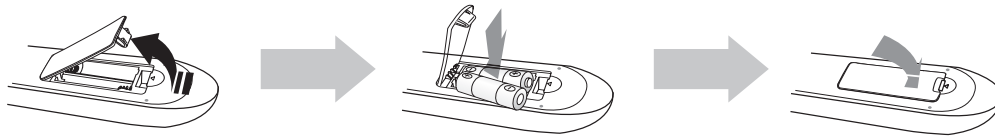

1. Lift the cover at the back of the remote control upward as shown.
2. Install two AAA size batteries. Make sure to match the "+" and "-" ends of the batteries with the diagram inside the compartment.
3. Replace the cover. Assuming typical TV usage, the batteries last for about one year.

Operation Range of the Remote Control

You can use the remote control up to 23 feet (7 meters) in a straight line from the unit. You can also operate the remote at a horizontal angle of up to 30° from the remote control sensor.

● REMOTE CONTROL

connections

INSTALLING THE WALL MOUNT

You can use the wall mount bracket to mount this unit on a wall.

Installation Precautions

- Install on a vertical wall only.
- For the installation, avoid a location with high temperature or humidity, or wall that cannot sustain the weight of the set.
- Check the strength of the wall. If the strength of the wall is insufficient for the product installation, make sure to reinforce the wall before the installation.
- Check the material of the wall. If the wall is made of plaster board, marble, or iron board, purchase and use the appropriate fixing screws or mollys.
- Connect cables from the unit to external devices before you install it on the wall.
- Make sure the unit is turned off and unplugged before you install it. Otherwise, it may cause an electric shock.

1. Place the wall mount bracket on a wall surface and then secure it with two screws (not supplied).
If you are hanging the unit below a TV, be sure to install the wall mount bracket so that the arrow (↑) is placed in the center of the TV.
Also make sure the unit is at least two inches (5 cm) below the TV.

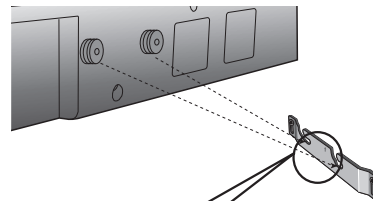
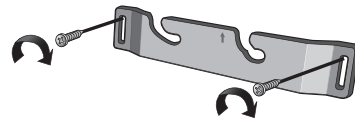

2. Fit the unit into the corresponding slots of the wall mount bracket. For secure installation, make sure the mounting studs slide firmly down into the bottom of the slots.

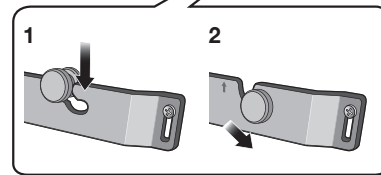

3. The installation is complete.

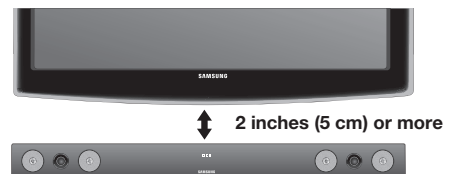

- Do not hang onto the installed unit and avoid any impact to the unit.
- Secure the unit firmly to the wall so that it does not fall off. If the unit falls off, it may cause an injury or damage to the product.
- When the unit is installed on a wall, please make sure that children do not pull any of the connecting cables, as it may cause it to fall.
- For the optimal performance of a wall mount installation, keep the speaker system at least 2 inches (5 cm) away from the TV.

CONNECTING THE WIRELESS SUBWOOFER

The Subwoofer's linking ID is preset at the factory and the main unit and sub should link (connect wirelessly) automatically when main unit is turned on. If the link indicator (📶) does not light when main unit and subwoofer are turned on, please set the ID by following the process below.

1. Plug the power cords of the main unit and subwoofer into an AC power supply.
2. Press the **ID SET** button on the back of the subwoofer with a small, pointed object for 5 seconds.
 - The STANDBY indicator is turned off and the LINK indicator (Blue LED) blinks quickly.

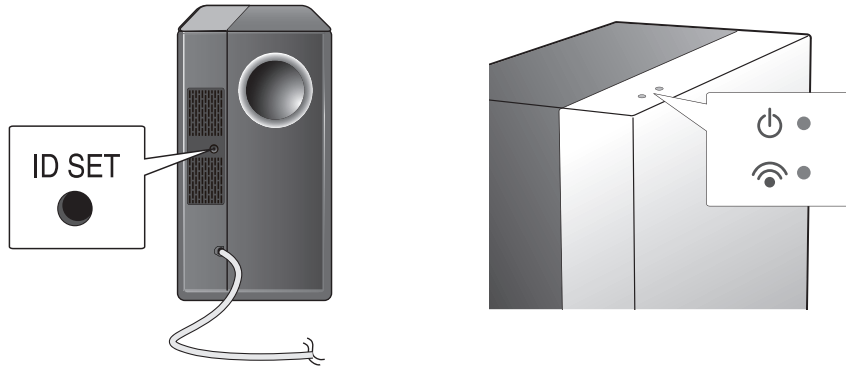

3. While the main unit is powered off (STANDBY mode), press **SAT MUTE** on the remote control for 5 seconds.
4. The **ID SET** message appears on the main unit's VFD.
5. To finalize the link, turn the main unit's power on while the subwoofer's Blue LED blinks.
 - The main unit and the subwoofer are now linked (connected).
 - The Link indicator (blue LED) on the subwoofer is turned on.
 - You can enjoy better sound from the wireless subwoofer by selecting the sound effect. (See page 20)

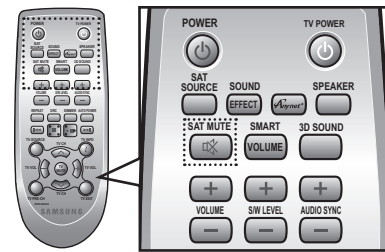

- Before moving or installing the product, be sure to turn off the power and disconnect the power cord.
- If the main unit is powered off, the wireless subwoofer will be in the standby mode and the STANDBY LED on the upper side will come on after the Link indicator (Blue LED) blinks for 30 seconds.
- If you use a device that uses the same frequency (2.4GHz) near the system, interference may cause some sound interruption.
- The transmission distance of the wireless signal between the main unit and sub is about 33 ft., but may vary depending on your operating environment. If a steel-concrete or metallic wall is between the main unit and the wireless subwoofer, the system may not operate at all, because the wireless signal cannot penetrate metal.
- If the main unit doesn't make a wireless connection, follow steps 1-5 above to retry the connection between the main unit and wireless subwoofer.



- The wireless receiving antenna is built into the wireless subwoofer. Keep the unit away from water and moisture.
- For optimal listening performance, make sure that the area around the wireless subwoofer location is clear of any obstructions.

INSTALLING THE TOROIDAL FERRITE ON THE HDMI IN/OUT CABLE

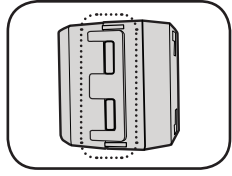

Lift up to release the lock and open the core.

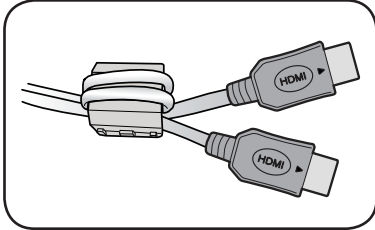
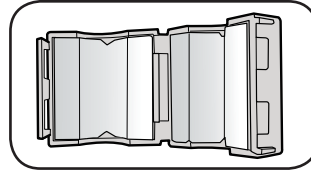

Close the lock back.

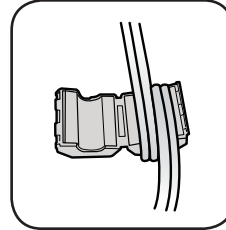

Wind both HDMI IN/OUT cables together, make one turn around the core.
(Start winding at 5-10cm away from the plugs)

INSTALLING THE FERRITE CORE ON THE AUDIO/USB CABLE

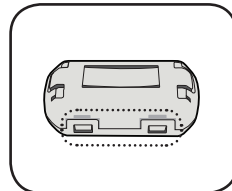

Lift up to release the lock and open the core.

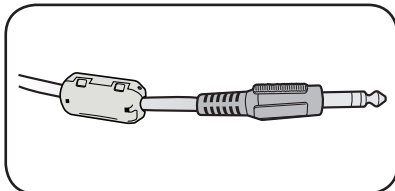
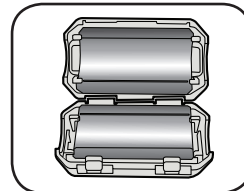

Close the lock back.

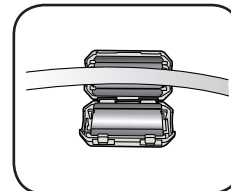

Place the audio cable or USB cable on the opened core.

CONNECTING THE CRYSTAL SURROUND AIR TRACK

HDMI is a standard digital interface for connecting to such devices as a TV, projector, DVD player, Blu-ray player, set top box and more.

HDMI removes any loss of signal from analog conversion, enabling you to enjoy video and audio sound quality as it was originally created in the digital source.

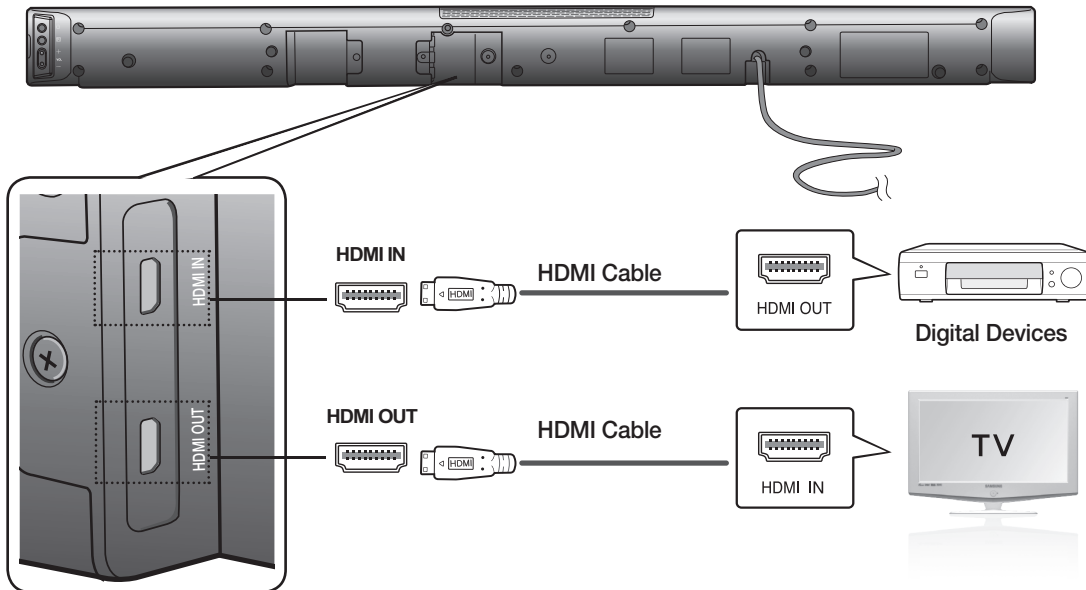

HDMI IN

Connect an HDMI cable (not supplied) from the HDMI IN jack on the back of the product to the HDMI OUT jack on your digital devices.

and,

HDMI OUT (HDMI)

- Connect an HDMI cable from the HDMI OUT jack on the back of the product to the HDMI IN jack on your TV.



- HDMI is an interface that enables the digital transmission of video and audio data with just a single connector.

HDMI OUT (ARC)

- The ARC function allows digital audio to output via the HDMI OUT (ARC) port. It can be enabled only when the Air Track is connected to a TV that supports the ARC function.
- Anynet+ must be turned on.



- This function is not available if the HDMI cable does not support CEC.

CONNECTING THE CRYSTAL SURROUND AIR TRACK

This section explains two ways (digital and analog) of connecting the unit to a TV.

This unit is equipped with one optical digital jack and one audio analog jack for connecting a TV.

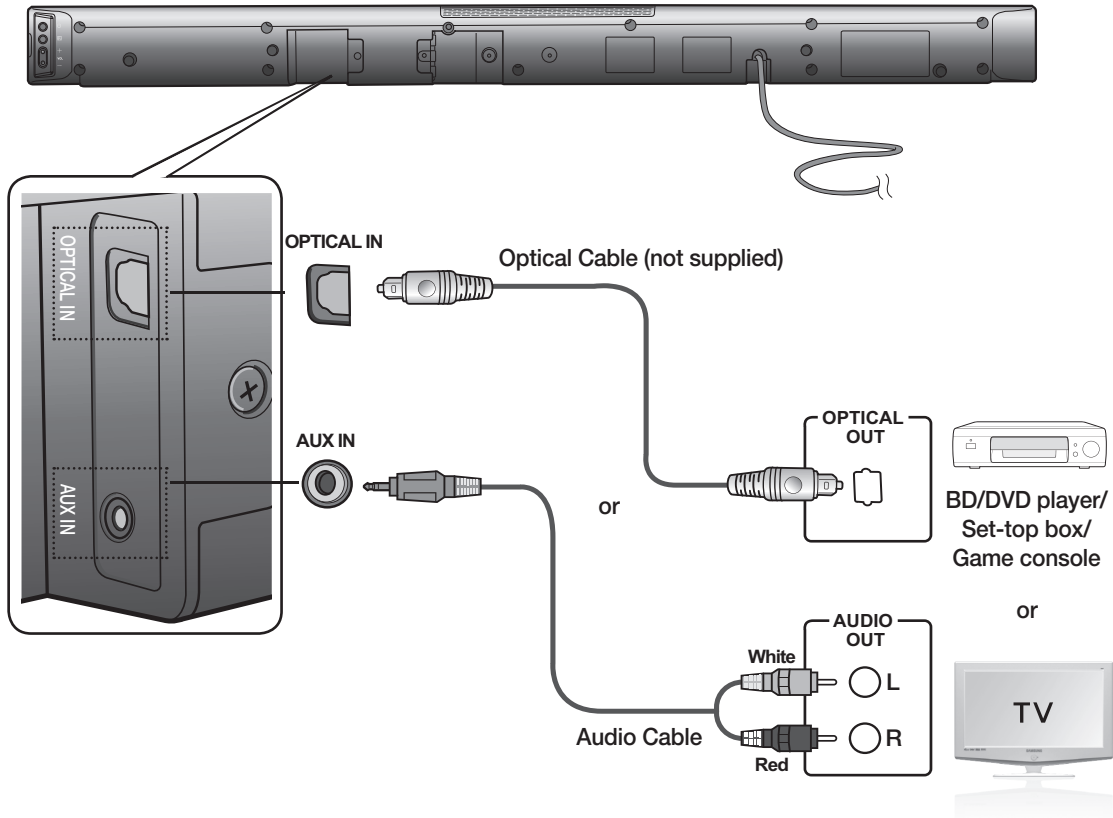

OPTICAL IN

Connect the Digital Input on the main unit to the OPTICAL OUT of the TV or Source Device.

or,

AUX IN

Connect AUX IN (Audio) on the main unit to the AUDIO OUT of the TV or Source Device. Be sure to match connector colors.



- Do not connect the power cord of this product or your TV to the wall outlet until all connections between components are complete.
- Before moving or installing this product, be sure to turn off the power and disconnect the power cord.
- If you select 'AUX' without connecting the Audio Cable, the set is turned off automatically after 20 minutes.
- If a TV or any device connected to Air Track with the optical cable is off and there is no digital input, the Air Track is turned off after 20 minutes. (If there has been no input signal for over 20 minutes from OPTICAL AUDIO IN the Air Track will be turned off.)

BASIC FUNCTIONS

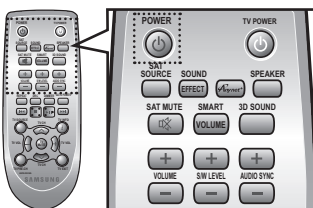
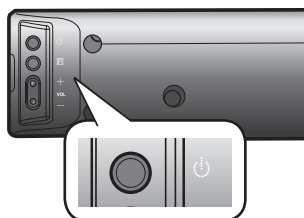

Turning the power on/off

1. Press the **POWER** (⏻) button in the right corner of the front panel.
or,
Press **POWER** on the remote control to turn on the power.
2. Press the **POWER** (⏻) button in the right corner of the front panel.
or,
Press **POWER** on the remote control again to turn off the power.

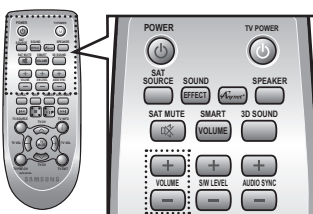
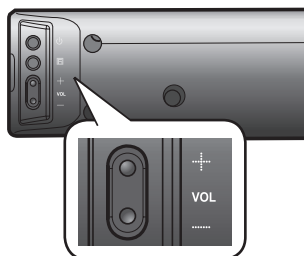

Adjusting the volume

Press the **VOLUME +/-** button in the right corner of the front panel.
or,
Press **VOLUME +/-** on the remote control to increase or decrease the volume level.

- The numeric value of the volume level appears in the front panel display.



- The volume level increases or decreases when you press VOLUME +/-.
- If you want to enjoy the sound only from the Crystal Surround Air Track, you must turn off the TV's speakers in the Audio Setup menu of your TV. Refer to the owner's manual supplied with your TV.

ADVANCED FUNCTIONS

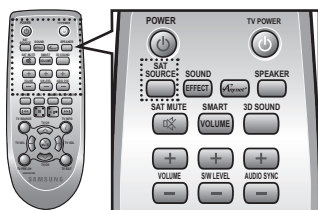
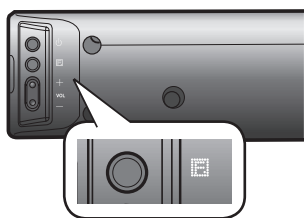

Using the input mode

You can select either D.IN, AUX, HDMI, BT input or USB input. Press an appropriate button on the remote control to select a desired mode, or press  to select one from: D.IN, AUX, HDMI, BT or USB mode.

Input mode	Display
Optical Digital input	D.IN
AUX input	AUX
HDMI input	HDMI
BLUETOOTH mode	BT
USB mode	USB

The unit turns off automatically in the following situations:

- D.In Mode: If no input source is entered for 20 minutes.
- Aux Mode: If no cable is inserted in the jack for 20 minutes.
- BT Mode: If no connection is made for 20 minutes.
- USB Mode: If the "NO USB" or "Stop" state lasts for 20 minutes.



- The ARC function is activated in D.IN mode if the unit is connected to an ARC supporting TV.
- To turn off the ARC function, turn Anynet off.
- Use the provided cable if the USB flash memory is not available directly in the unit.

USING BLUETOOTH

You can use a Bluetooth device to enjoy music with high quality stereo sound, all without wires!

What is Bluetooth?

Bluetooth is a technology that enables Bluetooth-compliant devices to easily interconnect with each other using a short wireless connection.

- A Bluetooth device may cause noise or malfunction, depending on usage, when:
 - A part of your body is in contact with the receiving/transmitting system of the Bluetooth device or the Air Track.
 - It is subject to electrical variation from obstructions caused by a wall, corner or office partitioning.
 - It is exposed to electrical interference from same frequency-band devices including medical equipment, microwave ovens and wireless LANs.
- Pair the Air Track with the Bluetooth device while maintaining a close distance.
- The further the distance is between Air Track and Bluetooth device, the worse the quality is. If the distance exceeds the Bluetooth operational range, the connection is lost.
- In poor reception-sensitivity areas, the Bluetooth connection may not work properly.
- The Air Track has an effective reception range of up to 10 meters in all directions if there are no obstacles. The connection will be automatically cut off if the distance is out of this range. Even within this range, the sound quality may be degraded by obstacles such as walls or doors.
- This wireless device may cause electric interference during its operation.

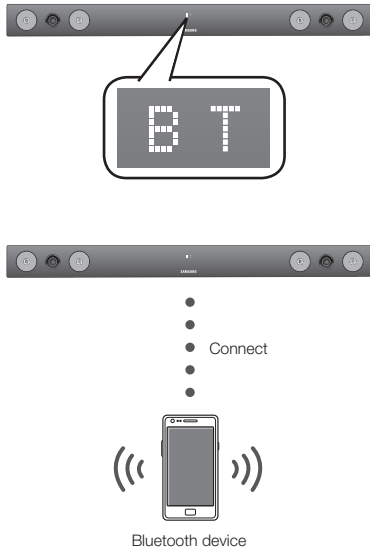

To connect the Air Track to a Bluetooth device

Check if the Bluetooth device supports the Bluetooth compliant stereo headset function.

1. Press the **FUNCTION** button on the remote control of AirTrack to display the **BT** message.
 - You will see **WAIT** for 4 seconds and then **READY** on the front display of the Air Track.
2. Select the Bluetooth menu on the Bluetooth device you want to connect. (refer to the Bluetooth device's user manual)
3. Select the Stereo headset menu on the Bluetooth device.
 - You will see a list of scanned devices.
4. Select "**Samsung Home Audio**" from the searched list.
 - When the Air Track is connected to the Bluetooth device, the device name of the connected Bluetooth device, followed by Air Track will display **CONN** on the front display.
 - If the Bluetooth device has failed to be paired with Air Track, delete the previous "SAMSUNG HOME AUDIO" found by the Bluetooth device and make it search for Air Track again.
5. Play music on the connected device.
 - You can listen to the music playing on the connected Bluetooth device over the Crystal Surround Air Track system.
 - In BT mode, Play/Repeat/Stop/Next/Back functions are not available.



- You may be required to enter a PIN code (password) when connecting the Bluetooth device to the Air Track. If the PIN code input window appears, enter <0000>.
- The Air Track only supports Middle Quality SBC data (up to 237kbps@48kHz), and does not support High Quality SBC data (328kbps@44.1kHz).
- The AVRCP feature is not supported.
- Connect only to a Bluetooth device that supports the A2DP (AV) function.
- You cannot connect to a Bluetooth device that supports only the HF (Hands Free) function.
- Only one Bluetooth device can be paired at a time.
- Once you have turned off Air Track and the pairing is disconnected, the pairing will not be restored automatically. To reconnect, you must pair the device again.
- Search or connection may not be performed properly by Air Track in the following cases:
 - If there is a strong electrical field around Air Track.
 - If several Bluetooth devices are simultaneously paired with AirTrack
 - If the Bluetooth device is turned off, not in place, or malfunctions
 - Note that such devices as microwave ovens, wireless LAN adaptors, fluorescent lights, and gas stoves use the same frequency range as the Bluetooth device, which can cause electric interference.

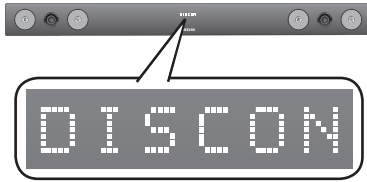

To disconnect the Bluetooth device from Air Track

You can disconnect the Bluetooth device from Air Track. For instructions, see the Bluetooth device's user manual.

- Air Track will be disconnected.
- When Air Track is disconnected from the Bluetooth device, Air Track will display **DISCON** on the front display.

To disconnect Air Track from the Bluetooth device

Press the  button on the front panel of Air Track to switch from **BT** to another mode or turn off Air Track.

- The connected Bluetooth device will wait a certain time for a response from Air Track before terminating the connection. (Disconnection time may differ, depending on the Bluetooth device)
- The currently connected device will be disconnected.



- In Bluetooth connection mode, the Bluetooth connection will be lost if the distance between the Home Cinema System and the Bluetooth device exceeds (10 meters). If the distance between them returns to the effective range or you restart the Bluetooth device, the Bluetooth connection can be restored.
- If the Bluetooth device comes back into the effective range, you can restart to restore the pairing with the Bluetooth device.
- Air Track automatically turns off after 20 minutes in the Ready state.

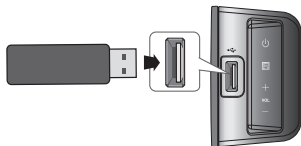

To connect the Crystal Surround Air Track to a USB HOST device

1. Connect the USB device to the USB port on the side of the unit.
2. Press the  button on the front panel of the home cinema system repeatedly until **USB** appears.
 - Each time the button is pressed, the selection changes as follows :
D.IN ➔ AUX ➔ HDMI ➔ BT ➔ USB
3. **USB** appears on the display screen and then disappears.
 - The Crystal Surround Air Track connection is complete.
 - It automatically turns off (Auto Power Off) if no USB device has been connected for more than 20 minutes.

Before you connect a USB device

Compatibility: USB storage.

- If the file name of a folder on a USB device exceeds 10 characters, it is not displayed on the VFD.
- This product may not be compatible with certain types of USB storage media.
- The file systems FAT16 and FAT32 are supported.
 - The NTFS file system is not supported.
- Connect a USB device directly to the USB port of the product. Otherwise, you may encounter a USB compatibility problem.

- Do not connect multiple storage devices to the product via a multi-card reader. It may not operate properly.
- Digital camera PTP protocols are not supported.
- Do not remove the USB device while it is being read.
- DRM-protected music files (MP3, WMA) from a commercial web site will not be played.
- External HDDs are not supported.
- Compatibility list

Format	Music	
File name	MP3	WMA
File extension	.MP3	.WMA
Bit rate	80~320 kbps	56~128 kbps
Version	-	V8
Pixel	-	-
Sampling Frequency	44.1KHz	44.1KHz

Play/Pause/Stop

During playback, press the ►||■ button.

- Press the ►|| button again to stop playing the file temporarily. Press the ►|| button to play the selected file.
- To stop playback, press the Stop (■) button during playback.

Skip Forward/Back

During playback, press the ◀◀▶▶ button.

- When there is more than one file and you press the ▶▶ button, the next file is selected.
- When there is more than one file and you press the ◀◀ button, the previous file is selected.

Using the REPEAT function

Repeat playback allows you to repeatedly play a file, repeat all, randomly play files, or turn Repeat off.

Press the **REPEAT** button.

- **REPEAT FILE** : Repeat playing a track
- **REPEAT ALL** : Repeat playing all tracks
- **REPEAT RANDOM** : Plays tracks in random order. (A track that has already been played may be played again.)
- **REPEAT OFF** : Cancels Repeat Playback.



- You can set the REPEAT function during the playback of music from a USB drive.

Muting the sound

This is useful when answering a doorbell or telephone call.

1. To mute sound of this unit, press the **SAT MUTE** (⊗) button of the remote control.
2. To mute the TV, press the **TV MUTE** button of the remote control.
3. Press **SAT MUTE** (⊗) / **TV MUTE** on the remote control again (or press **VOLUME +/-**) to restore the sound.

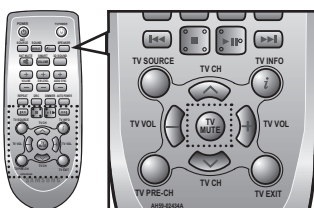
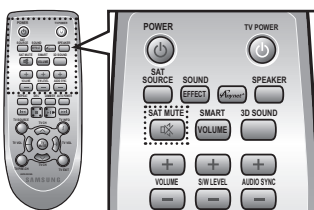
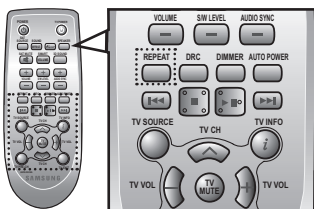
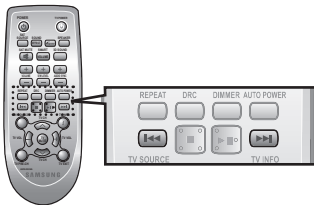
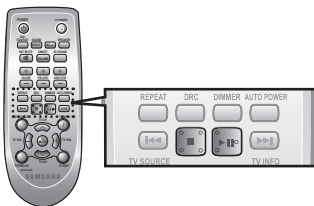

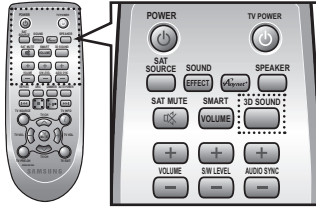

Using the 3D Depth Sound function

The 3D sound feature adds depth and spaciousness to the sound.

Press **3D SOUND** on the remote control.

- Each time the button is pressed, the selection changes as follows :
3D SOUND LOW ➔ 3D SOUND HIGH ➔ 3D SOUND OFF



- When you turn on the 3D Depth Sound, the Sound Effect will automatically change to OFF.

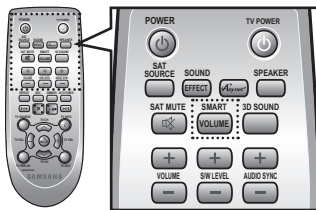

Using the SMART VOLUME function

This will regulate and stabilize the volume level against a drastic volume change caused by a channel change or scene transition.

Press **SMART VOLUME** on the remote control.

- Each time the button is pressed, the selection changes as follows :
SMART VOLUME ON ➔ SMART VOLUME OFF

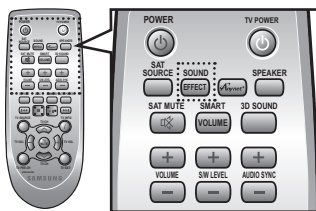

Using the Sound effect

You can select from 7 different sound modes - MUSIC, NEWS, DRAMA, CINEMA, SPORTS, GAME, and OFF (Original Sound) - depending on the type of sources you want to enjoy.

Press **SOUND EFFECT** on the remote control.

- Select **OFF** mode if you want to enjoy the original sound.



- We recommend that you select a Sound Effect based on the source material and your personal taste.
- When you choose the Sound Effect (except OFF), the 3D Depth Sound will automatically be turned OFF.

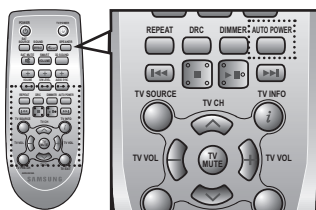

Using the AUTO POWER LINK function

The Crystal Surround Air Track is automatically turned on when you turn on the TV or any device connected to the Air Track with the optical cable.

Press **AUTO POWER** on the remote control of this unit.

- The Auto power link function turns on and off each time you press **AUTO POWER**.

AUTO POWER LINK	Display
ON	POWER LINK ON
OFF	POWER LINK OFF



- If a TV or any device connected to Air Track with the optical cable is off and there is no digital input, the Air Track is turned off after 20 minutes.
- These functions are available only when the CEC is turned off.

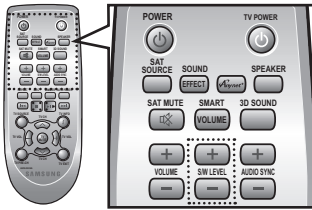

Using the S/W LEVEL function

You can control the base volume with the S/W Level button on the Remote control.

1. Press the **S/W LEVEL** button on the Remote control.
2. “**SW 0**” appears on the Display.
3. Press “**+**” or “**-**” button on the **LEVEL** key if you want to increase or decrease the subwoofer volume. You can set it from SW -6 to SW +6.

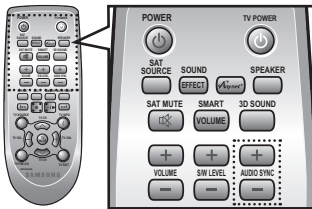

Using the AUDIO SYNC function

Video may look slower than the audio if Air Track is connected to a digital TV. If this occurs, adjust the audio delay time to match the video.

Press **AUDIO SYNC +/-** on the remote control of this unit.

- You can use +, - button to set the audio delay time between 0 ms and 300 ms.



- In USB mode or BT mode, the Audio Sync function may not work.

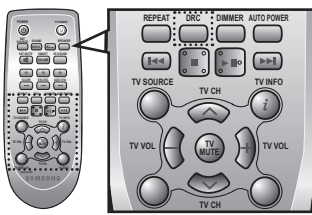

Using the DRC function

This feature balances the range between the loudest and quietest sounds. You can use this function to enjoy Dolby Digital sound when watching movies at low volume at night.

Press **DRC** on the remote control of this unit.

- Each time the button is pressed, the selection changes as follows :
DRC MIN ➔ DRC STANDARD ➔ DRC MAX

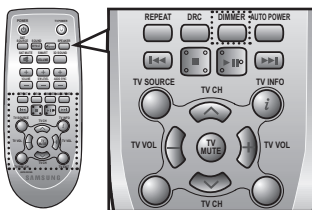

Using the DIMMER function

This feature control the brightness of the Display.

Press **DIMMER** on the remote control of this unit.

- Each time the button is pressed, the selection changes as follows :
DIMMER ON ➔ DIMMER OFF

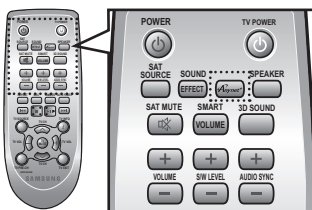

Using the Anynet+(HDMI-CEC) function

Anynet+ is a function that enables you to control other Samsung Devices with your Samsung TV's remote control.

The Anynet+ function turns on and off each time you press **Anynet+**.

1. Connect the product to a Samsung TV with the HDMI cable. (See page 13)
2. Set the Anynet+ function on your TV to ON. (See the TV instruction manual for more information.)



- Depending on your TV, certain HDMI output resolutions may not work.
- Please refer to the user's manual of your TV. Please check the **Anynet+** logo (If your TV has an **Anynet+** logo, then it supports Anynet+ function.)

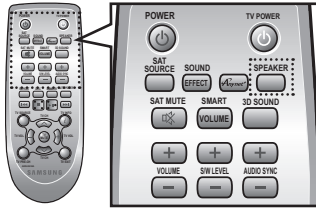

SPEAKER button

This button enables you to select between listening to audio from your TV or audio from the Air Track when connected via HDMI.

Press **SPEAKER** on the remote control of this unit.

AUDIO MODE	SPEAKER	Scroll Display	Display
HDMI IN	TV	TV SPEAKER	TV SPK
	Air Track	AVR SPEAKER	HDMI
ARC	TV	TV SPEAKER	S MUTE
	Air Track	AVR SPEAKER	TV ARC

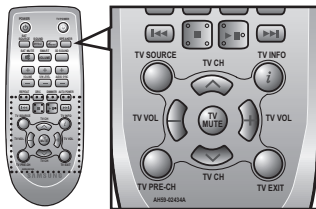

Using the TV functions

1. Press **TV SOURCE** on the remote control of this unit.
2. Press **TV INFO** on the remote control to display the TV channel information.
3. Press **TV CH** on the remote control to select the TV channel.
4. Press **TV VOL** on the remote control to increase or decrease the volume level.
5. Use **TV PRE-CH** button to move to the previous TV channel in TV mode.
6. To exit the TV menu, use the **TV EXIT** button. (Functions same as the EXIT button of the TV remote control)



- The remote control can operate TVs made by SAMSUNG only.

SOFTWARE UPGRADE

Samsung may offer upgrades for the Crystal Surround Air Track's system firmware in the future. If an upgrade is offered, you can upgrade the firmware by connecting a USB drive with the firmware upgrade stored on it to the USB port on your Air Track.

Note that if there are multiple upgrade files, you must load them onto the USB drive singly and use them to upgrade the firmware one at a time.

Please visit Samsung.com or contact the Samsung call center to receive more information about downloading upgrades files.

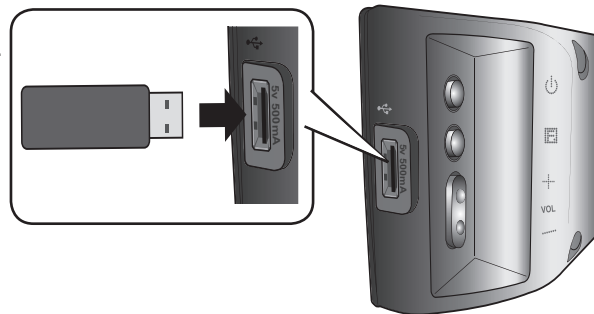

- Insert a USB drive containing the firmware upgrade into the USB port on the back of the main unit.
- Please be careful to not disconnect the power or remove the USB drive while upgrades are being applied. The main unit will turn off automatically after completing the firmware upgrade. When software is upgraded, settings you have made will return to their default (factory) settings. We recommend you write down your settings so that you can easily reset them after the upgrade.
- If the firmware fails to upgrade, we recommend formatting the USB data in FAT16 and trying again.
- For upgrading purposes, do not format the USB drive in NTFS format because it is not a supported file system.
- Depending on the manufacturer, the USB may not be supported.

troubleshooting

Before requesting service, please check the following.

Symptom	Check	Remedy
The unit will not turn on.	<ul style="list-style-type: none">• Is the power cord plugged into the outlet?	<ul style="list-style-type: none">• Connect the power plug to the outlet.
A function does not work when the button is pressed.	<ul style="list-style-type: none">• Is there static electricity in the air?	<ul style="list-style-type: none">• Disconnect the power plug and connect it again.
Sound is not produced.	<ul style="list-style-type: none">• Is the unit properly connected to your TV?• Is the Mute function on?• Is the volume set to minimum?	<ul style="list-style-type: none">• Connect it correctly.• Press the Mute button to cancel the function.• Adjust the volume.
The Picture does not appear on a TV when the function is selected.	<ul style="list-style-type: none">• Is the TV connected properly?	<ul style="list-style-type: none">• Connect it correctly.
The Remote control does not work.	<ul style="list-style-type: none">• Are the batteries drained?• Is the distance between remote control and main unit too far?	<ul style="list-style-type: none">• Replace with new batteries.• Operate at a close distance.
The sound from the left/right channels are reversed.	<ul style="list-style-type: none">• Are the left/right audio output cables from the TV connected properly?	<ul style="list-style-type: none">• Check the left/right channel and connect it/them correctly.

appendix

SPECIFICATIONS

Model name	HW-E450		
GENERAL	Power supply		AC 120V, 60Hz
	Standby power consumption		0.45W
	Power consumption	Main unit	25.9W
		Subwoofer	20W
	Weight	Main unit	4.28 lbs
		Subwoofer	12.01 lbs
	Dimensions (W x H x D)	Main unit	35.67 x 1.77 x 2.76 inches
		Subwoofer	6.89 x 13.78 x 11.61 inches
	Operating temperature range		+41°F to +95°F
	Operating humidity range		10 % to 75 %
AMPLIFIER	Rated output power	Main unit	80W/CH, 4OHM, THD = 10%, 1kHz
		Subwoofer	120W, 4OHM, THD = 10%, 100Hz
	Input sensitivity/Impedance		570mV/20Kohm
	S/N ratio (analog input)		70 dB
	Separation(1kHz)		65 dB
FREQUENCY RESPONSE	Analog input		20Hz~20kHz(±3 dB)
	Digital input/48kHz PCM		20Hz~20kHz(±3 dB)

* S/N ratio, distortion, separation and usable sensitivity are based on measurement using AES (Audio Engineering Society) guidelines.

*: Nominal specification

- Samsung Electronics Co., Ltd reserves the right to change the specifications without notice.
- Weight and dimensions are approximate.

WARRANTY

LIMITED WARRANTY TO ORIGINAL PURCHASER

This SAMSUNG brand product, as supplied and distributed by Samsung Electronics America, Inc. (SAMSUNG) and delivered new, in the original carton to the original consumer purchaser, is warranted by SAMSUNG against manufacturing defects in materials and workmanship for a limited warranty period of:

One (1) Year Parts and Labor*

(*90 Days Parts and Labor for Commercial Use)

This limited warranty begins on the original date of purchase, and is valid only on products purchased and used in the United States. To receive warranty service, the purchaser must contact SAMSUNG for problem determination and service procedures. Warranty service can only be performed by a SAMSUNG authorized service center. The original dated bill of sale must be presented upon request as proof of purchase to SAMSUNG or SAMSUNG's authorized service center. Transportation of the product to and from the service center is the responsibility of the purchaser.

SAMSUNG will repair or replace this product, at our option and at no charge as stipulated herein, with new or reconditioned parts or products if found to be defective during the limited warranty period specified above. All replaced parts and products become the property of SAMSUNG and must be returned to SAMSUNG. Replacement parts and products assume the remaining original warranty, or ninety (90) days, whichever is longer.

SAMSUNG's obligations with respect to software products distributed by SAMSUNG under the SAMSUNG brand name are set forth in the applicable end user license agreement. Non-SAMSUNG hardware and software products, if provided, are on an "AS IS" basis. Non-SAMSUNG manufacturers, suppliers, publishers, and service providers may provide their own warranties.

This limited warranty covers manufacturing defects in materials and workmanship encountered in normal, and except to the extent otherwise expressly provided for in this statement, noncommercial use of this product, and shall not apply to the following, including, but not limited to: damage which occurs in shipment; delivery and installation; applications and uses for which this product was not intended; altered product or serial numbers; cosmetic damage or exterior finish; accidents, abuse, neglect, fire, water, lightning or other acts of nature; use of products, equipment, systems, utilities, services, parts, supplies, accessories, applications, installations, repairs, external wiring or connectors not supplied and authorized by SAMSUNG, or which damage this product or result in service problems; incorrect electrical line voltage, fluctuations and surges; customer adjustments and failure to follow operating instructions, cleaning, maintenance and environmental instructions that are covered and prescribed in the instruction book; product removal or reinstallation; reception problems and distortion related to noise, echo, interference or other signal transmission and delivery problems. SAMSUNG does not warrant uninterrupted or error-free operation of the product.

THERE ARE NO EXPRESS WARRANTIES OTHER THAN THOSE LISTED AND DESCRIBED ABOVE, AND NO WARRANTIES WHETHER EXPRESS OR IMPLIED, INCLUDING, BUT NOT LIMITED TO, ANY IMPLIED WARRANTIES OF MERCHANTABILITY OR FITNESS FOR A PARTICULAR PURPOSE, SHALL APPLY AFTER THE EXPRESS WARRANTY PERIODS STATED ABOVE, AND NO OTHER EXPRESS WARRANTY OR GUARANTY GIVEN BY ANY PERSON, FIRM OR CORPORATION WITH RESPECT TO THIS PRODUCT SHALL BE BINDING ON SAMSUNG. SAMSUNG SHALL NOT BE LIABLE FOR LOSS OF REVENUE OR PROFITS, FAILURE TO REALIZE SAVINGS OR OTHER BENEFITS, OR ANY OTHER SPECIAL, INCIDENTAL OR CONSEQUENTIAL DAMAGES CAUSED BY THE USE, MISUSE OR INABILITY TO USE THIS PRODUCT, REGARDLESS OF THE LEGAL THEORY ON WHICH THE CLAIM IS BASED, AND EVEN IF SAMSUNG HAS BEEN ADVISED OF THE POSSIBILITY OF SUCH DAMAGES. NOR SHALL RECOVERY OF ANY KIND AGAINST SAMSUNG BE GREATER IN AMOUNT THAN THE PURCHASE PRICE OF THE PRODUCT SOLD BY SAMSUNG AND CAUSING THE ALLEGED DAMAGE. WITHOUT LIMITING THE FOREGOING, PURCHASER ASSUMES ALL RISK AND LIABILITY FOR LOSS, DAMAGE OR INJURY TO PURCHASER AND PURCHASER'S PROPERTY AND TO OTHERS AND THEIR PROPERTY ARISING OUT OF THE USE, MISUSE OR INABILITY TO USE THIS PRODUCT SOLD BY SAMSUNG NOT CAUSED DIRECTLY BY THE NEGLIGENCE OF SAMSUNG. THIS LIMITED WARRANTY SHALL NOT EXTEND TO ANYONE OTHER THAN THE ORIGINAL PURCHASER OF THIS PRODUCT, IS NONTRANSFERABLE AND STATES YOUR EXCLUSIVE REMEDY.

Some states do not allow limitations on how long an implied warranty lasts, or the exclusion or limitation of incidental or consequential damages, so the above limitations or exclusions may not apply to you. This warranty gives you specific legal rights, and you may also have other rights which vary from state to state.

To obtain warranty hardware service, please contact SAMSUNG customer care center.



QUESTIONS OR COMMENTS?

COUNTRY	CALL	OR VISIT US ONLINE AT	WRITE
IN THE US	1-800-SAMSUNG (7267864)	www.samsung.com/us	Samsung Electronics America, Inc. 85 Challenger Road Ridgefield Park, NJ 07660-2112

Code no. AH68-02431A (00)