



<https://www.sony.net/SonyInfo/Support/>

SONY®

5-010-473-11(1)

α9 II

Interchangeable Lens
Digital Camera

α9 II

E-mount

Instruction Manual



"Help Guide" (Web manual)

Refer to "Help Guide" for in-depth instructions on the many functions of the camera.

https://rd1.sony.net/help/ilc/1960/h_zz/



5010473110

Check out the Help Guide!



The “Help Guide” is an on-line manual that you can read on your computer or smartphone. Refer to it for details on menu items, advanced usage, and the latest information on the camera.



Scan here

https://rd1.sony.net/help/ilc/1960/h_zz/

ILCE-9M2 Help Guide



Instruction Manual (this book)



This manual introduces some basic functions.

For the quick start guide, see “Startup guide” (page 35). The “Startup guide” introduces the initial procedures from when you open the package until you release the shutter for the first shot.

In-Camera Guide



The [In-Camera Guide] shows explanations of the menu items on the monitor of the camera.

You can quickly pull up information during shooting.

Select an item for which you want to view a description, and then press the  (Delete) button.







Table of contents











Check out the Help Guide!.....	2
Notes on using your camera.....	11





Preparations for shooting

Checking the camera and the supplied items	15
Identifying parts.....	16
Front side	16
Rear side	17
Top side.....	19
Sides.....	21
Bottom	24
Basic operations.....	25
Using the control wheel	25
Using the multi-selector.....	26
Using the Fn (Function) button (Function menu)	26
How to use the Quick Navi screen	28
Changing the screen display	31
Switching the screen display (while shooting/during playback)	31
DISP Button (Monitor/Finder)	33
Startup guide	35
Step 1: Charging the battery pack	35
Step 2: Inserting the battery pack into the camera.....	36
Step 3: Inserting a memory card.....	37
Step 4: Attaching a lens	39
Step 5: Setting the language and the clock.....	42
Step 6: Shooting images in auto mode	43







Shooting

Shooting still images	45
Focusing	47
Focus Mode	47
Auto focus	49
Focus Area	49
Adjusting the focus area settings to the camera's orientation (horizontal/vertical)	
 Switch V/H AF Area)	54
AF/MF control	55
AF On	56
Face/Eye AF Set.	56
Tracking subject (Tracking function)	60
Registering the current focus area ()	61
Focus Frame Color	63
 AF Illuminator	63
Circ. of Focus Point	64
AF Micro Adj.	64
Aperture Drive in AF	66
Manual Focus	67
Direct manual focus (DMF)	68
Focus Magnifier	69
 MF Assist	70
Shutter setting	71
 Shutter Type	71
Using the electronic shutter	72
Displaying the release timing (Shoot. Timing Disp.) ...	75
Shoot. Start Disp.	76
 Anti-flicker Shoot.	76
e-Front Curtain Shutter	78
Shooting with drive modes (continuous shooting/self-timer)	79
Continuous shooting	80
Self-timer	82
Self-timer (Cont)	83
Cont. Bracket	84

Single Bracket	85
Indicator during bracket shooting	86
WB bracket.....	87
DRO Bracket.....	88
Interval Shooting.....	90
Using touch function	93
Touch Operation	93
Touch Panel/Pad.....	93
Touch Focus	94
Touch Tracking.....	95
Selecting a still image size/image quality	97
 File Format.....	97
 RAW File Type.....	98
 JPEG Quality.....	98
 JPEG Image Size	99
 Aspect Ratio	100
APS-C/Super 35mm.....	100
Selecting a shooting mode.....	101
List of mode dial function	101
AUTO (i  Intelligent Auto).....	102
P Program Auto.....	103
A Aperture Priority.....	104
S Shutter Priority.....	105
M Manual Exposure	106
M Bulb shooting.....	107
MR  1/  2 Recall.....	108
 Movie:  Exposure Mode	109
S&Q S&Q Motion: S&Q Exposure Mode.....	110
Controlling the exposure/metering modes	111
Exposure Comp.....	111
Metering Mode	113
Face Priority in Multi Metering	114
Spot Metering Point.....	115
AE lock	116
Correcting brightness and contrast automatically.....	117
D-Range Optimizer (DRO)	117
Auto HDR	118





Selecting the ISO sensitivity	120
ISO Range Limit	121
ISO AUTO Min. SS.....	121
Using the zoom.....	123
The zoom features available with this product	123
Clear Image Zoom/Digital Zoom (Zoom)	124
About zoom scale.....	125
White Balance	126
Capturing a standard white color to set the white balance (custom white balance).....	127
 Shutter AWB Lock.....	128
Setting how to process images	130
Creative Style	130
 Color Space.....	133
Reducing blur.....	134
SteadyShot Settings	134
Noise reduction.....	136
 Long Exposure NR.....	136
 High ISO NR.....	137
Using flash (sold separately).....	138
Flash Mode	139
Flash Comp.	140
FEL lock	141
Wireless Flash	142
Using a flash with a sync terminal cord	143

Shooting movies

Shooting movies	145
Changing settings for movie recording.....	149
 File Format.....	149
 Record Setting.....	150
 S&Q Settings.....	152
Audio Recording.....	154
Audio Rec Level	155
 Marker Settings.....	156
 4K Output Select	157
 Proxy Recording.....	158

Viewing images	159
Playing back still images	159
Enlarging an image being played back (⊕ Enlarge Image).....	160
Rotating recorded images automatically (Display Rotation).....	161
Playing back movies.....	161
Photo Capture.....	162
Playing back images on the image index screen (Image Index)	163
Setting the method for jumping between images (Image Jump Setting).....	164
Switching between still images and movies (View Mode)	165
Cont. PB for  Interval	165
Selecting which memory card to play back (Select Playback Media).....	166
Copying images from one memory card to another (Copy)	166
Playing back images using slideshow (Slide Show)...	167
Protecting images (Protect)	168
Setting rating function.....	170
Attaching audio files to images (Voice Memo).....	172
Deleting images.....	174
Deleting a displayed image	174
Deleting multiple selected images (Delete)	174

Customizing the camera

Registering frequently used functions.....	176
MR  1/  2 Memory.....	176
Registering shooting settings to a custom key (Reg. Custom Shoot Set).....	177
Assigning frequently used functions to buttons (Custom Key).....	179
Customizing the functions of the dial.....	181
Changing the function of the dial temporarily (My Dial Settings).....	181
Customizing the MENU (My Menu).....	183
Add Item.....	183
Sort Item.....	183
Delete Item.....	184
Display From My Menu.....	184
Checking images before/after recording.....	185
Auto Review.....	185
Aperture Preview.....	185
Shot. Result Preview.....	186
Monitor/viewfinder settings.....	187
FINDER/MONITOR.....	187
 Finder Frame Rate.....	188
Memory card settings.....	189
Format.....	189
 File/Folder Settings.....	189
 File Settings.....	191
Rec. Media Settings.....	192
Camera settings.....	195
Power Save Start Time.....	195
IR Remote Ctrl.....	195
HDMI Settings.....	196
USB Power Supply.....	200
Save/Load Settings.....	201
Initializing the camera.....	202
Setting Reset.....	202





Using network functions

Using the Wi-Fi/One-touch (NFC)/Bluetooth/wired LAN functions	203
Installing Imaging Edge Mobile	203
Recording location information to captured images	204
Transferring images to the FTP server	204
Connecting the camera and a smartphone	205
Using a smartphone as a remote control for the camera	205
Transferring images from the camera to a smartphone.....	207
Connecting the camera to a wireless access point.....	208
Using a remote commander with Bluetooth communication	209

Using a computer

Connecting the camera to a computer	211
Selecting the appropriate USB connection method...	211
Operating the camera from a computer (PC Remote Function)	212
Introduction to computer software	213
Imaging Edge	213
PlayMemories Home	214
Remote Camera Tool	214

MENU items/List of icons

Using MENU items	215
List of MENU items	216
 1 (Camera Settings 1)	216
 2 (Camera Settings 2)	222
 (Network)	226
 (Playback)	227
 (Setup)	229
★ (My Menu)	232
List of icons on the monitor	233
Icons on the shooting screen	233
Icons on the playback screen	237

About this product

Troubleshooting	239
Cleaning the image sensor	240
Attaching accessories	242
Mount Adaptor	242
Vertical grip	246
Specifications	247
Battery life and number of recordable images	247
Memory cards that can be used	248
Number of recordable images	249
Recordable movie times	250
Specifications	253

Index	257
--------------------	------------

Notes on using your camera

Along with this section, also see “Precautions” in the Help Guide.

Notes on handling the product

- This camera is designed to be dust resistant and splash resistant, but it is not guaranteed to completely prevent the ingress of dust or water droplets.
- Do not leave the lens or the viewfinder exposed to a strong light source such as sunlight. Because of the lens’s condensing function, doing so may cause smoke, fire, or a malfunction inside the camera body or the lens. If you have to leave the camera exposed to a light source such as sunlight, attach the lens cap to the lens.
- When you shoot with backlighting, keep the sun sufficiently far away from the angle of view. Otherwise, the sunlight may focus inside the camera and cause smoke or fire. Even if the sun is slightly away from the angle of view, it may still cause smoke or fire.
- Do not directly expose the lens to beams such as laser beams. That may damage the image sensor and cause the camera to malfunction.
- Do not look at sunlight or a strong light source through the lens when it is detached. This may result in unrecoverable damage to the eyes.
- Do not leave the camera, the supplied accessories, or memory cards within the reach of infants. They may be accidentally swallowed. If this occurs, consult a doctor immediately.

Notes on the monitor and electronic viewfinder

- The monitor and electronic viewfinder are manufactured using extremely high-precision technology, and over 99.99% of the pixels are operational for effective use. However, there may be some small black dots and/or bright dots (white, red, blue or green in color) that constantly appear on the monitor and electronic viewfinder. These dots are normal due to the manufacturing process and do not affect the images in any way.
- When shooting with the viewfinder, you may experience symptoms such as eyestrain, fatigue, travel sickness, or nausea. We recommend that you take a break at regular intervals when you are shooting with the viewfinder.
- If the monitor or electronic viewfinder is damaged, stop using the camera immediately. The damaged parts may harm your hands, face, etc.

Notes on continuous shooting

During continuous shooting, the monitor or viewfinder may flash between the shooting screen and a black screen. If you keep watching the screen in this situation, you may experience uncomfortable symptoms such as feeling of unwellness. If you experience uncomfortable symptoms, stop using the camera, and consult your doctor as necessary.

Notes on recording for long periods of time or recording 4K movies

- The camera body and battery may become warm with use – this is normal.
- If the same part of your skin touches the camera for a long period of time while using the camera, even if the camera does not feel hot to you, it may cause symptoms of a low-temperature burn such as redness or blistering. Pay special attention in the following situations and use a tripod, etc.
 - When using the camera in a high-temperature environment
 - When someone with poor circulation or impaired skin sensation uses the camera
 - When using the camera with the [Auto Power OFF Temp.] set to [High].

Notes on shooting with an external flash

When shooting with an external flash, light and dark stripes may appear on the image if the shutter speed is set to faster than 1/4000 seconds.

Sony lenses/accessories

Using this unit with products from other manufacturers may affect its performance, leading to accidents or malfunction.

On the data specifications described in this manual

The data on performance and specifications are defined under the following conditions, except as described in this manual: at an ordinary ambient temperature of 25°C (77°F), and using a battery pack that has been fully charged until the charge lamp has turned off.

Warning on copyright

Television programs, films, videotapes, and other materials may be copyrighted. Unauthorized recording of such materials may be contrary to the provisions of the copyright laws.

Notes on location information

If you upload and share an image tagged with a location, you may accidentally reveal the information to a third party. To prevent third parties from obtaining your location information, set [Location Info. Link Set.] to [Off] before shooting images.

Notes on discarding or transferring this product to others

When discarding or transferring this product to others, make sure to perform the following operation to protect private information.

- [Setting Reset] → [Initialize]

Notes on discarding or transferring a memory card to others

Executing [Format] or [Delete] on the camera or a computer may not completely delete the data on the memory card. When transferring a memory card to others, we recommend that you delete the data completely using data deletion software. When discarding a memory card, we recommend that you physically destroy it.

Note on network functions

When you use network functions, unintended third parties on the network may access the camera, depending on the usage environment.

For example, unauthorized access to the camera may occur in network environments to which another network device is connected or can connect without permission. Sony bears no responsibility for any loss or damage caused by connecting to such network environments.

Note on the 5 GHz band for wireless LAN

When using the wireless LAN function outdoors, set the band to 2.4 GHz by following the procedure below. (WW942051 only)

- MENU →  (Network) → [Wi-Fi Settings]

How to turn off wireless network functions (Wi-Fi, etc.) temporarily

When you board an airplane, etc., you can turn off all wireless network functions temporarily using [Airplane Mode].

CAUTION

For safety, do not connect the connector for peripheral device wiring that might have excessive voltage to LAN terminal. Follow the instructions for LAN terminal.

Power Cord

For the customers in the UK, Ireland, Malta, Cyprus and Saudi Arabia Use the power cord (A). For safety reasons, the power cord (B) is not intended for above countries/regions and shall therefore not be used there. For the customers in other EU countries/regions Use the power cord (B).

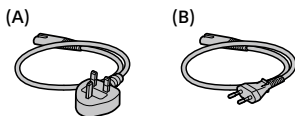

LAN cable

Use a Category 5e or higher Shielded Twisted Pair (STP) cable with high shielding performance.

For Customers in the U.S.A.

For question regarding your product or for the Sony Service Center nearest you, call 1-800-222-SONY (7669).

Supplier's Declaration of Conformity

Trade Name: SONY

Model No.: WW942051

Responsible Party: Sony Electronics
Inc.

Address: 16535 Via Esprillo, San
Diego, CA 92127 U.S.A.

Telephone Number: 858-942-2230

This device complies with part 15 of the FCC rules. Operation is subject to the following two conditions:

(1) This device may not cause harmful interference, and (2) this device must accept any interference received, including interference that may cause undesired operation.

For customers who purchased their camera from a store in Japan that caters to tourists

Note

Some certification marks for standards supported by the camera can be confirmed on the screen of the camera.

Select MENU →  (Setup) → [Certification Logo].

Checking the camera and the supplied items

The number in parentheses indicates the number of pieces.

- Camera (1)
- Battery charger (1)



- Power cord (mains lead) (1)* (supplied in some countries/regions)



* Multiple power cords may be supplied with this equipment. Use the appropriate one that matches your country/region. See page 13.

- Rechargeable battery pack NP-FZ100 (1)



- USB Type-C™ cable (1)

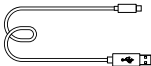

- Shoulder strap (1)

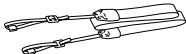

- Body cap (1) (Attached to the camera)



- Cable protector (1)



- Shoe cap (1) (Attached to the camera)

- Eyepiece cup (1) (Attached to the camera)

- Instruction Manual (1) (this manual)

- Reference Guide (1)

Identifying parts

See the pages in parentheses for details.

Front side

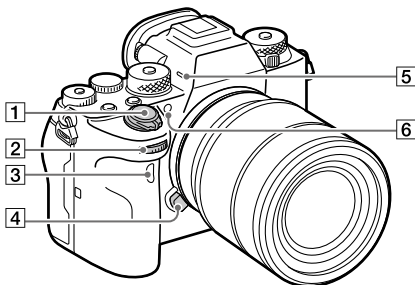

- 1 ON/OFF (Power) switch (42)/Shutter button (45)
- 2 Front dial
You can quickly adjust the settings for each shooting mode.
- 3 Infrared remote sensor
- 4 Lens release button (41)
- 5 Microphone
Do not cover this part during movie recording. Doing so may cause noise or lower the volume.
- 6 AF illuminator (63)/Self-timer lamp (82)

When the lens is removed

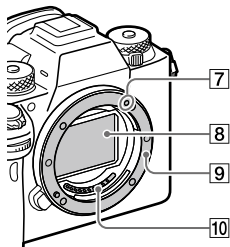

- 7 Mounting index (40)
- 8 Image sensor*
- 9 Mount
- 10 Lens contacts*

* Do not directly touch these parts.

Rear side

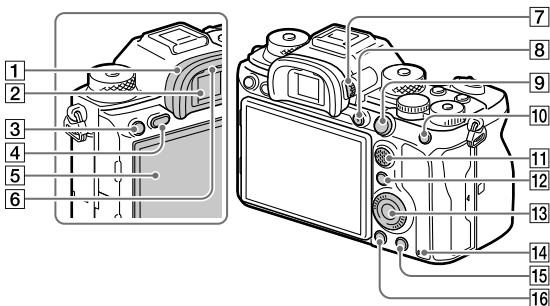

1 Eyepiece cup

To remove the eyepiece cup

Push the grips at the bottom of the eyepiece cup to the left and right and lift up the cup.

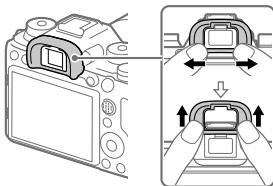

Remove the eyepiece cup when attaching an angle finder (sold separately).

Also, select MENU → 2 (Camera Settings 2) → [FINDER/MONITOR], and then switch to [Viewfinder (Manual)] or [Monitor (Manual)].

2 Viewfinder

3 C3 button (Custom button 3) (179)/ (Protect) button (168)

4 MENU button (215)



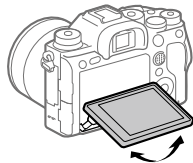

5 Monitor (For touch operation: Touch panel/Touch pad) (31, 93) You can adjust the monitor to an easily viewable angle and shoot from any position.

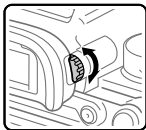

6 Eye sensor (187)

- 7 Diopter-adjustment dial**
Adjust the diopter-adjustment dial according to your eyesight until the display appears clearly in the viewfinder. If it is hard to operate the diopter-adjustment dial, remove the eyepiece cup before operating the dial.



- 8 MOVIE (Movie) button (145)**
- 9** For shooting: AF-ON (AF On) button (56)
For viewing:  (Enlarge Image) button (160)
- 10** For shooting: AEL button (116)
For viewing:  (Image Index) button (163)
- 11** Multi-selector (26)
- 12** For shooting: Fn (Function) button (26, 225)
For viewing:  (Send to Smartphone) button
You can display the screen for [Send to Smartphone] by pressing this button.
- 13** Control wheel (25)
- 14** Access lamp
- 15** For shooting: C4 button (Custom button 4) (179)
For viewing:  (Delete) button (174)
- 16**  (Playback) button (159)

Top side

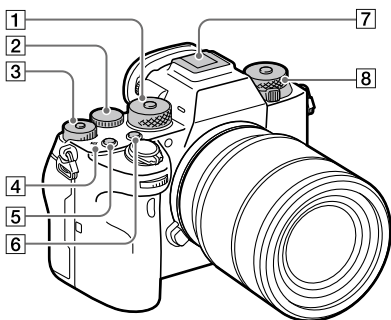

1 Mode dial (101)

The mode dial is unlocked while you hold down the unlock button at the center.

2 Rear dial

You can quickly adjust the settings for each shooting mode.

3 Exposure compensation dial (111)

Pressing the lock button at the center switches the exposure compensation dial between the locked and unlocked status. The dial is unlocked when the lock button is popped up and the white line is visible.

4 Image sensor position mark

- The image sensor is the sensor that converts light into an electric signal. The  mark shows the location of the image sensor. When you measure the exact distance between the camera and the subject, refer to the position of the horizontal line.

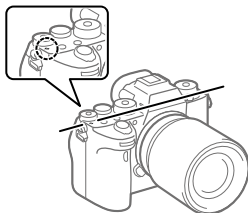

- If the subject is closer than the minimum shooting distance of the lens, the focus cannot be confirmed. Make sure you put enough distance between the subject and the camera.

5 C1 button (Custom button 1) (179)

6 C2 button (Custom button 2) (179)

7 Multi Interface Shoe* (138)
Some accessories may not go in all the way and protrude backward from the Multi interface shoe. However, when the accessory reaches the front end of the shoe, the connection is completed.

8 Upper: Drive mode dial (79)
The drive mode dial is unlocked while the unlock button at the center is being pressed.
Lower: Focus mode dial (47)
The focus mode dial is unlocked while the unlock button at the front is being pressed.

- * For details on compatible accessories for the Multi Interface Shoe, visit the Sony website, or consult your Sony dealer or local authorized Sony service facility. Accessories for the Accessory Shoe can also be used. Operations with other manufacturers' accessories are not guaranteed.

mi Multi
Interface Shoe

Accessory Shoe

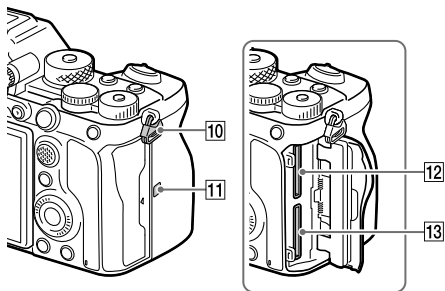
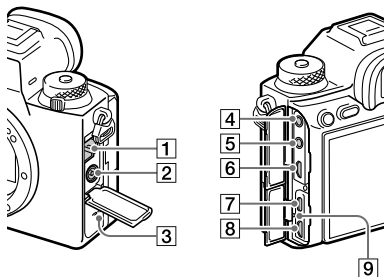

- 1 LAN terminal
- 2 ⚡ (Flash sync) terminal (143)
- 3 Speaker
- 4 🎤 (Microphone) jack
When an external microphone is connected, the built-in microphone turns off automatically. When the external microphone is a plugin-power type, the power of the microphone is supplied by the camera.
- 5 🎧 (Headphones) jack
- 6 HDMI micro jack
- 7 USB Type-C terminal (22)
- 8 Multi/Micro USB Terminal* (22)
This terminal supports Micro USB-compatible devices.
- 9 Charge lamp

- 10 Hooks for shoulder strap**
Attach both ends of the strap onto the camera.

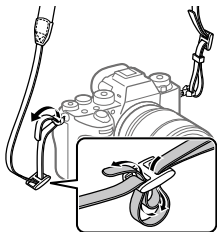

- 11 N (N-Mark) (203)**
- This mark indicates the touch point for connecting the camera and an NFC-enabled Smartphone.

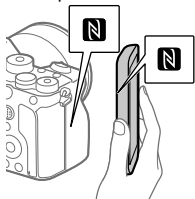

- NFC (Near Field Communication) is an international standard of short-range wireless communication technology.
- 12 SLOT 1 (Memory card slot 1) (37)**
Supports SD cards only (compatible with UHS-I and UHS-II)

- 13 SLOT 2 (Memory card slot 2) (39)**
Supports SD cards only (compatible with UHS-I and UHS-II)

* For details on compatible accessories for the Multi/Micro USB Terminal, visit the Sony website, or consult your Sony dealer or local authorized Sony service facility.

Notes on USB terminals

You can use either the USB Type-C terminal or the Multi/Micro USB Terminal for supplying power, charging the battery, and USB communications. However, you cannot conduct these operations with both terminals simultaneously.

- The battery charging time does not change according to the terminal you use.
- You can use accessories for the Multi/Micro USB Terminal, such as a remote commander (sold separately), while supplying power or performing PC Remote shooting using the USB Type-C terminal.

Notes on the terminal cover

Ensure that the terminal cover is closed before use.

Notes on the cable protector

Use the cable protector to prevent a cable from being disconnected when shooting images with the cable connected.

To attach the cable protector

① Open both of the jack covers on the monitor side.

② Fit the two hooks on the rear side of the cable protector into the two notches to the left of the USB Type-C terminal and Multi/Micro USB Terminal, and then align the cable protector with the terminal part of the camera.

③ Push the attachment screw in and turn it to secure the cable protector.

④ Insert the cable into one of the jacks.

⑤ Insert the cable into the holding part and then secure the cable with the fixing dial.

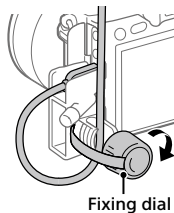
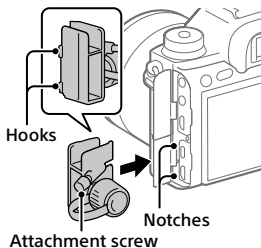

To remove the cable protector

Loosen the attachment screw, and then remove the cable protector.

Bottom

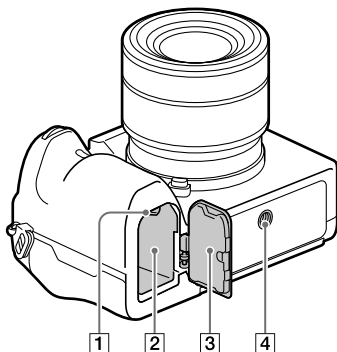

- 1 Lock lever (36)
- 2 Battery insertion slot (36)
- 3 Battery cover (36)
When attaching an accessory such as a vertical grip (sold separately), remove the battery cover.

To remove the battery cover
Pull the battery cover release lever in the direction of the arrow, and then remove the battery cover.

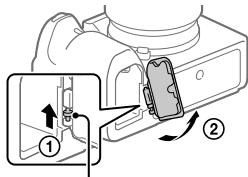

Battery cover release lever

To attach the battery cover
Insert the shaft on one side of the battery cover into the attachment site, and then push in the battery cover by attaching the shaft on the opposite side.

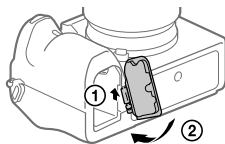

- 4 Tripod socket hole
Use a tripod with a screw less than 5.5 mm (7/32 inches) long. Otherwise, you cannot firmly secure the camera, and damage to the camera may occur.

Basic operations

Using the control wheel

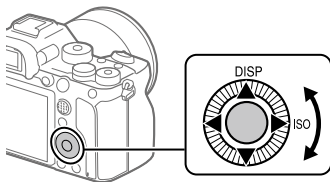

- You can select setting items by turning or pressing the top/bottom/left/right side of the control wheel. Your selection is determined when you press the center of the control wheel.
- The DISP (Display Setting) and ISO (ISO) functions are assigned to the top/right side of the control wheel. In addition, you can assign selected functions to the left/right/bottom side and the center of the control wheel, and to the rotation of the control wheel.
- During playback, you can display the next/previous image by pressing the right/left side of the control wheel or by turning the control wheel.

Using the multi-selector

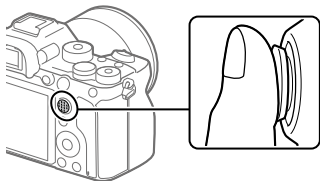

- Put your finger right on top of the multi-selector to manipulate it more precisely.
- When [Focus Area] is set to [Zone], [Flexible Spot], [Expand Flexible Spot], [Tracking: Zone], [Tracking: Flexible Spot], or [Tracking: Expand Flexible Spot], you can move the focus area by pressing the multi-selector up/down/left/right.
- The [Focus Standard] function is assigned to the center of the multi-selector in the default settings.

Using the Fn (Function) button (Function menu)

The Function menu is a menu of 12 functions that is displayed at the bottom of the screen when you press the Fn (Function) button in the shooting mode. You can access frequently used functions more quickly by registering them to the function menu.



Hint

- You can register twelve functions to the Function menus for still image shooting and movie shooting, respectively.
- You can recall functions more quickly by using the custom key function (page 179) to assign frequently used functions to desired keys, along with the function menu.

- 1 Press the DISP on the control wheel repeatedly to display a screen mode other than [For viewfinder], and then press the Fn (Function) button.**



- 2 Select the desired function by pressing the top/bottom/left/right side of the control wheel.**

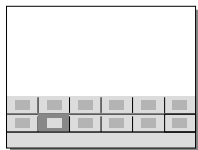

- 3 Select the desired setting by turning the front dial, and press the center of the control wheel.**

- Some functions can be fine-tuned using the rear dial.



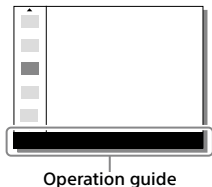

■ To adjust settings from the dedicated setting screens

Select the desired function in step 2, then press the center of the control wheel. The dedicated setting screen for the function will appear. Follow the operating guide to adjust settings.





■ To change the functions in the function menu (Function Menu Set.)

The following is the procedure for changing [Drive Mode] in the function menu for still images to [Grid Line].

- To change the movie function menu, select a movie function menu item in Step ②.
- ① **MENU** →  **2 (Camera Settings 2)** → **[Function Menu Set.]**.
 - ② Select  **(Drive Mode)** from among the twelve still image function menu items using the top/bottom/left/right side of the control wheel, and then press the center.
 - ③ Move to the **[Display/Auto Review]** screen using the left/right side of the control wheel. Then, select **[Grid Line]** and press the center of the control wheel.
 -  **(Grid Line)** will be displayed in the former location of  **(Drive Mode)** in the function menu.

How to use the Quick Navi screen

The Quick Navi screen is a function optimized for shooting with the viewfinder, that lets you control settings directly.

- 1 **MENU** →  **2 (Camera Settings 2)** → **[DISP Button]** → **[Monitor]**.
- 2 Place a  mark on **[For viewfinder]** and then select **[Enter]**.
- 3 Press the **DISP** on the control wheel to set the screen mode to **[For viewfinder]** (page 34).

4 Press the Fn button to switch to the Quick Navi screen.

- The displayed contents and their positions in the illustrations are just guidelines, and may differ from the actual displays.

Auto mode



P/A/S/M mode



5 Select a function to set by pressing the top/bottom/left/right side of the control wheel.

6 Select the desired setting by turning the front dial.

- Some functions can be fine-tuned using the rear dial.

To adjust settings from the dedicated setting screens

Select the desired function in step 5, then press the center of the control wheel. The dedicated setting screen for the function will appear. Follow the operating guide to adjust settings.



Operation guide

Note

- Items that are gray on the Quick Navi screen are not adjustable.
- When using [Creative Style], etc., some of the setup tasks can only be accomplished on a dedicated screen.

Changing the screen display

Switching the screen display (while shooting/during playback)

You can change the display contents on the screen.

Press the DISP (Display Setting) button.

- To switch the information displayed on the viewfinder, press the DISP button while looking into the viewfinder.
- Each time you press the DISP button, the screen display changes.
- The displayed contents and their position are just a guideline, and may differ from the actual display.

During shooting (Monitor)

Display All Info.

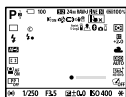

No Disp. Info.

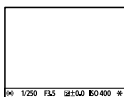

Histogram

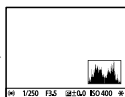

For viewfinder

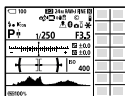

Level

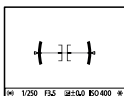

During shooting (Viewfinder)

Level

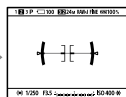

No Disp. Info.



Histogram

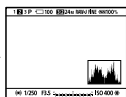

During playback (Monitor/Viewfinder)

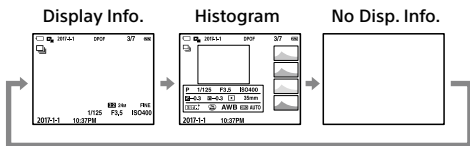

- If the image has an overexposed or underexposed area, the corresponding section will blink on the histogram display (overexposed/underexposed warning).
- The settings for playback are also applied in [Auto Review].

Histogram display

A histogram shows the luminance distribution, displaying how many pixels there are by luminance. It shows darker toward the left and brighter toward the right.

The histogram changes depending on the exposure compensation.

A peak at the right or left end of the histogram indicates that the image has an overexposed or underexposed area, respectively. You cannot correct such defects using a computer after shooting. Perform exposure compensation before shooting as necessary.

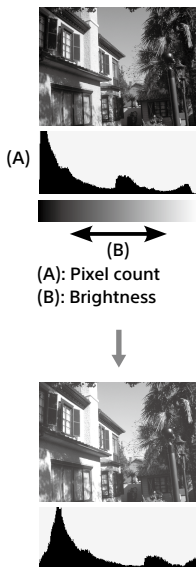

Note

- The viewfinder display and the monitor display for shooting can be set separately. Look through the viewfinder to set the display settings for the viewfinder.
- The information in the histogram display does not indicate the final photograph. It is information about image displayed on the screen. The final result depends on the aperture value, etc.
- The histogram display is extremely different between shooting and playback in the following cases:
 - When the flash is used
 - When shooting a low luminance subject such as a night scene
- In movie mode, [For viewfinder] cannot be displayed.

Hint

- The following are not displayed in the default settings.
 - Graphic Display
 - Monitor Off
 - Display All Info. (when using the viewfinder)

To change the display modes that are switched when you press the DISP button, select MENU →  2 (Camera Settings 2) → [DISP Button] and change the setting.

DISP Button (Monitor/Finder)

Allows you to set the screen display modes that can be selected using DISP (Display Setting) in shooting mode.

MENU →  2 (Camera Settings 2) → [DISP Button] → [Monitor] or [Finder] → **desired setting** → [Enter].

The items marked with ✓ are available.

Graphic Display: Shows basic shooting information. Graphically shows the shutter speed and aperture value.

Display All Info.: Shows recording information.

No Disp. Info.: Does not show recording information.

Histogram: Displays the luminance distribution graphically.

Level: Indicates whether the product is level in both the front-back and horizontal directions. When the product is level in either direction, the indicator turns to green.

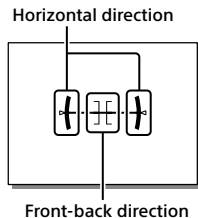

For viewfinder*: Displays only shooting information on the monitor, not the subject. This setting is a display setting for shooting with the viewfinder.

Monitor Off*: Always turns the monitor off when shooting images. You can use the monitor when playing back images or operating MENU. This setting is a display setting for shooting with the viewfinder.

* These screen modes are available only in the setting for [Monitor].

Note

- If you tilt the product forward or backward by a large degree, the level error will be great.
- The product may have a margin of error of almost $\pm 1^\circ$ even when the inclination is corrected by the level.

Startup guide

Step 1: Charging the battery pack

1 Insert the battery pack into the battery charger.

- Place the battery pack on the battery charger in the direction of the ▲.
- Slide the battery pack in the direction of the arrow as far as it will go.

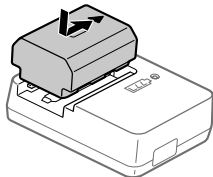

2 Connect the power cord (supplied) to the battery charger, and connect the battery charger to the wall outlet (wall socket).

The CHARGE lamp on the battery charger will light up in orange and charging will start.

CHARGE lamp (orange)

Lit: Charging

Flashing: Charging error or charging paused temporarily because the camera is not within the proper temperature range

- When charging is finished, the CHARGE lamp and all indicators turn off.
- Charging time (full charge): approximately 150 min. (when charging a fully depleted battery pack at a temperature of 25°C (77°F))
- When you use a completely new battery pack or a battery pack that has not been used for a long time, the CHARGE lamp may flash quickly when the battery is charged for the first time. If this happens, remove the battery pack and then re-insert it to recharge.
- Be sure to use only genuine Sony brand battery packs.

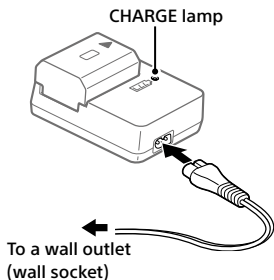

Step 2: Inserting the battery pack into the camera

1 Open the battery cover.

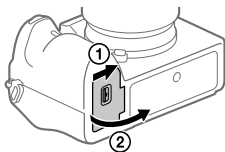

2 Insert the battery pack while pressing the lock lever with the tip of the battery until the battery locks into place.

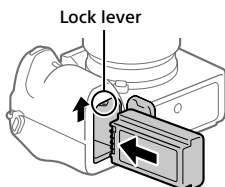

3 Close the cover.

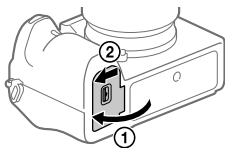

■ To charge the battery pack while it is inserted in the camera

Turn the camera off and connect it to a device such as a computer using the USB cable.

If you turn on the camera, power will be supplied from the computer or the device that you connected, and you will be able to operate the camera. However, the battery pack will not charge.

Use the USB Type-C cable (supplied) or a USB-standard cable.

■ To remove the battery pack

Make sure that the access lamp (page 18) is not lit, and turn off the camera. Then, slide the lock lever and remove the battery pack. Be careful not to drop the battery pack.

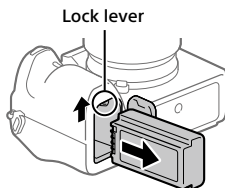

Step 3: Inserting a memory card

For details on memory cards that can be used with this camera, refer to page 248.

1 Open the memory card cover.

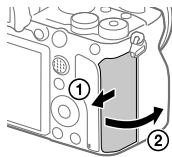

2 Insert the SD card into the slot 1.

- Both the slot 1 (upper) and the slot 2 (lower) only support SD memory cards (compatible with UHS-II).
- This camera does not support Memory Stick media.
- Insert the memory card with the terminal side facing toward you, until it clicks into place.
- You can change which memory card slot to use by selecting MENU →  (Setup) → [Rec. Media Settings] → [Prioritize Rec. Media]. The slot 1 is used in the default settings.

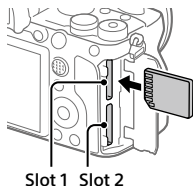

3 Close the cover.

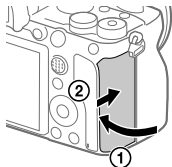

Hint

- When you use a memory card with the camera for the first time, it is recommended that you format the card on the camera for more stable performance of the memory card (page 189).

■ To remove the memory card

Make sure that the access lamp (page 18) is not lit, and then push in the memory card once to remove it.

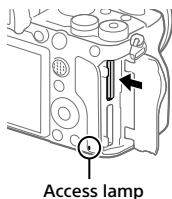

■ To record to memory cards in two slots

The slot 1 is used in the default settings. If you do not intend to change the settings and will only use one memory card, use the slot 1.

By inserting another memory card into the slot 2, you can record the same images to two memory cards simultaneously or record a different type of image (still images/movies) to each memory card ([Recording Mode] under [Rec. Media Settings]) (page 193).

Step 4: Attaching a lens

1 Remove the body cap from the camera and the rear lens cap from the rear of the lens.

- When changing the lens, work quickly in a dust-free environment to keep dust or debris from getting inside the camera.
- It is recommended that you attach the front lens cap when you have done shooting.

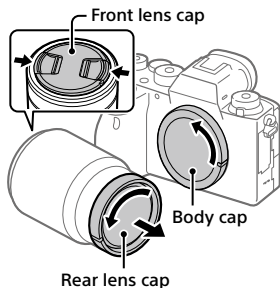

2 Mount the lens by aligning the two white index marks (mounting indexes) on the lens and camera.

- Hold the camera with the lens facing down to prevent dust or debris from entering the camera.

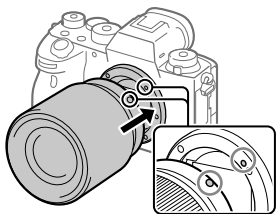

3 While pushing the lens lightly toward the camera, turn the lens slowly in the direction of the arrow until it clicks into the locked position.

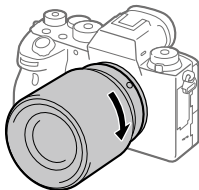

Note

- Be sure to hold the lens straight and do not use force when attaching a lens.
- Do not press the lens release button when attaching a lens.
- The Mount Adaptor (sold separately) is required to use an A-mount lens (sold separately). For details, refer to the operating manual supplied with the Mount Adaptor.
- If you want to shoot full-frame images, use a full-frame size compatible lens.
- When carrying the camera with a lens attached, hold both the camera and the lens firmly.
- Do not hold the part of the lens that is extended for zoom or focus adjustment.

To remove the lens

Keep pressing the lens release button and turn the lens in the direction of the arrow until it stops.

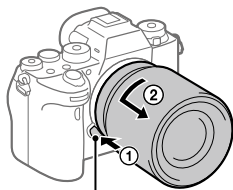

Lens release button

Compatible lenses

Lenses compatible with this camera are as follows:

Lens		Compatibility with the camera
A-mount lens	Lens compatible with 35 mm full-frame format	✓ (An optional Mount Adaptor (sold separately) compatible with full-frame format is required)
	APS-C size dedicated lens	✓* (An optional Mount Adaptor (sold separately) is required)
E-mount lens	Lens compatible with 35 mm full-frame format	✓
	APS-C size dedicated lens	✓*

* Images will be recorded in APS-C size. The angle of view will correspond to approximately 1.5 times the focal length indicated on the lens. (For example, the angle of view will correspond to 75 mm when a 50 mm-lens is attached.)

Step 5: Setting the language and the clock

- 1 Set the ON/OFF (Power) switch to "ON" to turn on the camera.

ON/OFF (Power) switch

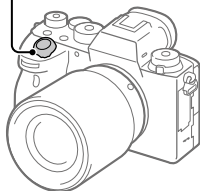

-
- 2 Select the desired language and then press the center of the control wheel.



Control wheel

-
- 3 Make sure that [Enter] is selected on the screen and then press the center.
-
- 4 Select the desired geographic location and then press the center.
-
- 5 Select [Date/Time] using the top/bottom of the control wheel or by turning the control wheel, and then press the center.
-
- 6 Select the desired item by pressing the top/bottom/left/right side of the control wheel, and then press the center.

7 Repeat steps 5 and 6 to set other items, then select [Enter] and press the center.

Hint

- To reset the date and time setting, use MENU (page 230).

Note

- This camera does not have a function for inserting the date into images. You can insert the date into images and then save and print them using PlayMemories Home (for Windows only).

Step 6: Shooting images in auto mode

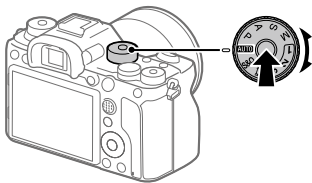

1 Press and hold the lock release button in the center of the mode dial, then turn the mode dial to set to **AUTO**.

The shooting mode will be set to **i** (Intelligent Auto).

2 Look into the viewfinder or the monitor and hold the camera.

3 Set the size of the subject by rotating the zoom ring of the lens when a zoom lens is attached.

4 Press the shutter button halfway down to focus.

- When the image is in focus, an indicator (such as ●) will light up.

5 Press the shutter button all the way down.

■ To shoot movies

Press the MOVIE button to start/stop recording.

■ To play back images

Press the  (Playback) button to play back images. You can select the desired image using the control wheel.

■ To delete displayed image

Press the  (Delete) button while an image is displayed to delete it. Select [Delete] using the control wheel on the confirmation screen, and then press the center of the control wheel to delete the image.

■ To shoot images in various shooting modes

Set the mode dial to the desired mode depending on the subject or the functions you want to use (page 101).

Shooting still images

1 Select the desired shooting mode by turning the mode dial.

- Turn the mode dial while pressing the mode dial lock release button in the center of the mode dial.

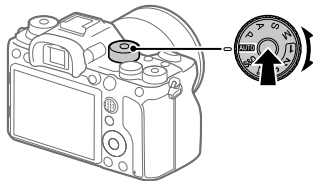

2 Adjust the monitor angle, and hold the camera. Or look through the viewfinder and hold the camera.

3 When a zoom lens is mounted, enlarge images by rotating the zoom ring.

4 Press the shutter button halfway down to focus.

- When the image is in focus, a beep sounds and the indicator (such as ●) lights up.

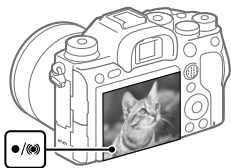

5 Press the shutter button fully down.

To shoot images with the focus locked on the desired subject (Focus-lock)

Shoots images with the focus locked on the desired subject in auto focus mode.

① Turn the focus mode dial to select AF-S (Single-shot AF).

- Turn the focus mode dial while holding down the focus mode dial lock release button.

② Place the subject within the AF area and press the shutter button halfway down.

The focus is locked.

- If it is difficult to focus on the desired subject, set [Focus Area] to [Center] or [Flexible Spot].



③ Keep pressing the shutter button halfway down, and place the subject back in the original position to re-compose the shot.



④ Press the shutter button down fully to take the picture.

Hint

- When the product cannot focus automatically, the focus indicator flashes and the beep does not sound. Either re-compose the shot or change the focus setting. In [Continuous AF] mode, (●) lights up and the beep indicating that the focus has been achieved does not sound.
- An icon indicating that data is being written is displayed after shooting. Do not remove the memory card while the icon is displayed.

Focusing

Focus Mode

Selects the focus method to suit the movement of the subject.

Turn the focus mode dial while pressing the focus mode dial lock release button and select the desired mode.

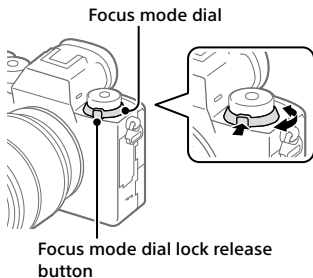

AF-S (Single-shot AF): The product locks the focus once focusing is complete. Use this when the subject is motionless.

AF-C (Continuous AF): The product continues to focus while the shutter button is pressed and held halfway down. Use this when the subject is in motion. In [Continuous AF] mode, there is no beep when the camera focuses.

DMF (DMF): You can make fine adjustments manually after performing auto focusing, letting you focus on a subject more quickly than when using the manual focus from the beginning. This is convenient in situations such as macro shooting.

MF (Manual Focus): Adjusts the focus manually. If you cannot focus on the intended subject using auto focus, use manual focus.

Focus indicator

- **(lit):** The subject is in focus and the focus is locked.
- **(flashing):** The subject is not in focus.
- ⦿ **(lit):** The subject is in focus. The focus will be adjusted continuously according to the movements of the subject.
- ⦿ **(lit):** Focusing is in progress.

Subjects on which it is difficult to focus using auto focus

- Dark and distant subjects
- Subjects with poor contrast
- Subjects seen through glass
- Fast-moving subjects
- Reflective light or shiny surfaces
- Flashing light
- Back-lit subjects
- Continuously repetitive patterns, such as the facades of buildings
- Subjects in the focusing area with different focal distances

Hint

- In [Continuous AF] mode, you can lock the focus by pressing and holding the button that has been assigned the [Focus Hold] function (page 179).
- When you set the focus to infinity in the manual focus mode or the direct manual focus mode, make sure that the focus is on a sufficiently distant subject by checking the monitor or the viewfinder.

Note









- When [Continuous AF] is set, the angle of view may change little by little while focusing. This does not affect the actual recorded images.
- Even if the focus mode dial is set to AF-S or DMF, the focus mode will switch to [Continuous AF] when shooting movies or when the mode dial is set to S&Q.

Auto focus

Focus Area

Selects the focusing area. Use this function when it is difficult to focus properly in the auto focus mode.

MENU →  1 (Camera Settings 1) → **[Focus Area]** → **desired setting.**

-  **Wide:** Focuses on a subject covering the whole range of the screen automatically. When you press the shutter button halfway down in the still image shooting mode, a green frame is displayed around the area that is in focus.
-  **Zone:** Select a zone on the monitor on which to focus, and the product will automatically select a focus area.
-  **Center:** Focuses automatically on a subject in the center of the image. Use together with the focus-lock function to create the composition you want.
-  **Flexible Spot:** Allows you to move the focusing frame to a desired point on the screen and focus on an extremely small subject in a narrow area.
-  **Expand Flexible Spot:** If the product cannot focus on a single selected point, it uses focus points around the flexible spot as a secondary priority area for focusing.
-     **Tracking:** When the shutter button is pressed and held halfway down, the product tracks the subject within the selected autofocus area. This setting is available only when the [Focus Mode] is set to [Continuous AF]. Point the cursor at [Tracking] on the [Focus Area] setting screen, and then adjust the desired area to start tracking using the left/right sides of the control wheel. You can also move the tracking start area to the desired point by designating the area as a zone, flexible spot or expand flexible spot.

Examples of the focusing frame display

The focusing frame differs as follows.

When focusing on a larger area

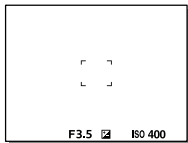

When focusing on a smaller area

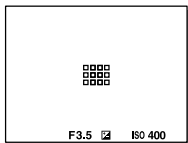

- When [Focus Area] is set to [Wide] or [Zone], the focusing frame may switch between "When focusing on a larger area" and "When focusing on a smaller area" depending on the subject or situation.
- When you attach an A-mount lens with a Mount Adaptor (LA-EA1 or LA-EA3) (sold separately), the focusing frame for "When focusing on a smaller area" may be displayed.

When focus is achieved automatically based on the whole range of the monitor

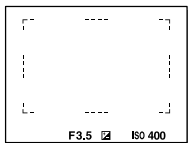

- When you use a zoom function other than the optical zoom, the [Focus Area] setting is disabled and the focusing frame is shown by the dotted line. The AF operates with priority on and around the center area.

To move the focus area

- You can move the focus area in [Flexible Spot], [Expand Flexible Spot], [Zone], [Tracking: Flexible Spot], [Tracking: Expand Flexible Spot], or [Tracking: Zone] by operating the multi-selector. If you assign [Focus Standard] to the center of the multi-selector beforehand, you can move the focusing frame back to the center of the monitor by pressing the center of the multi-selector.
- You can move the focusing frame quickly by touching and dragging it on the monitor. Set [Touch Operation] (page 93) to [On] and [Func. of Touch Operation] (page 94) to [Touch Focus] beforehand.

To track the subject temporarily (Tracking On)

You can temporarily change the setting for [Focus Area] to [Tracking] while you press and hold down the custom key to which you have assigned [Tracking On] in advance. The [Focus Area] setting before you activated [Tracking On] will switch to the equivalent [Tracking] setting.

For example:

[Focus Area] before you activate [Tracking On]	[Focus Area] while [Tracking On] is active
[Wide]	[Tracking: Wide]
[Flexible Spot: S]	[Tracking: Flexible Spot S]
[Expand Flexible Spot]	[Tracking: Expand Flexible Spot]

Hint

- In the default settings, [Focus Area] is assigned to the C2 button.

Note

- [Focus Area] is locked to [Wide] in the following situations:
 - [Intelligent Auto]
- The focus area may not light up during continuous shooting or when the shutter button is pressed all the way down at once.
- When the mode dial is set to  (Movie) or **S&Q**, or during movie shooting, [Tracking] cannot be selected as the [Focus Area].



Focus Area Limit

By limiting the types of available focus area settings in advance, you can more quickly select settings for [Focus Area].



MENU →  1 (Camera Settings 1) → [Focus Area Limit] → Add check marks to the focus areas that you want to use, and then select [OK].

The types of focus areas marked with  will be available as settings.

Hint

- When you assign [Switch Focus Area] to a desired key by selecting MENU →  2 (Camera Settings 2) → [ Custom Key] or [ Custom Key], the focus area changes every time you press the assigned key. By limiting the types of selectable focus areas with [Focus Area Limit] in advance, you can more quickly select the focus area setting you want.
If you assign [Switch Focus Area] to a custom key, it is recommended that you limit the types of focus areas with [Focus Area Limit].



Note

- Types of focus areas that do not have a check mark cannot be selected using MENU or the Fn (function) menu. To select one, add a check mark using [Focus Area Limit].
- If you remove the check mark for a focus area registered with [ Switch V/H AF Area] or [ AF Area Registration], the registered settings will change.

Phase detection AF





When there are phase detection AF points within the auto focus area, the product uses the combined autofocus of the phase detection AF and contrast AF.

Note

- Phase detection AF is available only when an applicable lens is attached. If you use a lens that does not support phase detection AF, you cannot use [ AF Tracking Sens.], [ AF Tracking Sens.] or [ AF drive speed]. Also, even if you use a previously purchased applicable lens, the phase detection AF might not function unless you update the lens.

Focus Standard

If you assign [Focus Standard] to the desired custom key, you can recall useful functions such as focusing on a subject in the center of the screen automatically in accordance with the focus area settings.

- ① **MENU →  2 (Camera Settings 2) → [ Custom Key] → desired key, then assign the [Focus Standard] function to the key.**
 - To use the [Focus Standard] function while shooting movies, select MENU →  2 (Camera Settings 2) → [ Custom Key] → the desired button, and then assign [Focus Standard] to the key.
- ② **Press the key to which [Focus Standard] is assigned.**
 - What you can do by pressing the key varies depending on the setting for [Focus Area].

When [Focus Area] is set to [Zone], [Flexible Spot], [Expand Flexible Spot], [Tracking: Zone], [Tracking: Flexible Spot] or [Tracking: Expand Flexible Spot]:

Pressing the key moves the focusing frame back to the center.

When [Focus Area] is set to [Wide], [Center], [Tracking: Wide] or [Tracking: Center]:

The camera focuses on the center of the screen when you press the key.

Note

- You cannot set the [Focus Standard] function to [Left Button], [Right Button] or [Down Button].

Adjusting the focus area settings to the camera's orientation (horizontal/vertical) (Switch V/H AF Area)

You can set whether to switch the [Focus Area] and the position of the focusing frame according to the orientation of the camera (horizontal/vertical).

This function is useful when shooting scenes for which you have to change the camera position frequently, such as portraits or sports scenes.

MENU → 1 (Camera Settings 1) → **Switch V/H AF Area** → **desired setting**.

Off: Does not switch the [Focus Area] and the position of the focusing frame according to the orientation of the camera (horizontal/vertical).

AF Point Only: Switches the position of the focusing frame according to the orientation of the camera (horizontal/vertical). The [Focus Area] is fixed.

AF Point + AF Area: Switches both the [Focus Area] and the position of the focusing frame according to the orientation of the camera (horizontal/vertical).

An example when [AF Point + AF Area] is selected

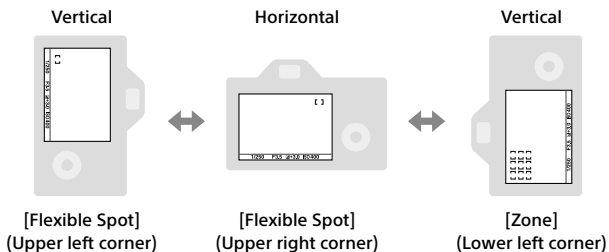

- Three camera orientations are detected: horizontal, vertical with the side of the shutter button facing up, and vertical with the side of the shutter button facing down.

Note

- If the setting for [Switch V/H AF Area] is changed, the focus settings for each camera orientation will not be retained.
- The [Focus Area] and the position of the focusing frame will not change even when [Switch V/H AF Area] is set to [AF Point + AF Area] or [AF Point Only] in the following situations:
 - When the shooting mode is set to [Intelligent Auto], [Movie], or [S&Q Motion]
 - While the shutter button is pressed halfway down
 - During movie shooting
 - While using the digital zoom function
 - While the auto-focusing is activated
 - When [Focus Settings] are activated
 - During continuous shooting
 - During the countdown for the self-timer
 - When [Focus Magnifier] is activated
- When you shoot images right after the power is turned on and the camera is vertical, the first shot is taken with the horizontal focus setting or with the last focus setting.
- The orientation of the camera cannot be detected when the lens is facing up or down.

AF/MF control

You can easily switch the focusing mode from auto to manual and vice versa while shooting without changing your holding position.

MENU → 2 (Camera Settings 2) → [Custom Key] or [Custom Key] → desired button → [AF/MF Control Hold] or [AF/MF Ctrl Toggle].

AF/MF Control Hold: Switches the focusing mode while the button is held down.

AF/MF Ctrl Toggle: Switches the focusing mode until the button is pressed again.

Note





- You cannot set the [AF/MF Control Hold] function to [Left Button], [Right Button] or [Down Button] of the control wheel.

AF On

You can focus without pressing the shutter button halfway down. The settings for the focus mode dial will be applied.

Press the AF-ON (AF On) button while shooting in autofocus mode.

Hint

- Set [ AF w/ shutter] to [Off] when you do not want to perform auto focusing using the shutter button.
- Set [,  Pre-AF], and [ Eye-Start AF] to [Off] to focus at a specific shooting distance predicting the position of the subject.

Face/Eye AF Set.

This function is used to determine whether or not the camera will focus with priority on faces or eyes.

There are two ways to perform [Eye AF]. For details, refer to the “Help Guide.”

- Focusing on the eyes by pressing the shutter button halfway down.
- Focusing on the eyes by pressing the custom key. For details on using the custom key to perform [Eye AF], refer to page 58.

MENU →  1 (Camera Settings 1) → [Face/Eye AF Set.] → desired setting item.

Face/Eye Priority in AF: Sets whether or not to detect faces or eyes inside the focusing area and focus on the eyes (Eye AF) when autofocus is activated. ([On]/[Off])

(Note: The camera operations are different when using the custom key to execute [Eye AF].)

Subject Detection: Selects the target to be detected.

[Human]: Detects human faces/eyes.

[Animal]: Detects animal eyes. Animal faces are not detected.

Right/Left Eye Select: Specifies the eye to be detected when [Subject Detection] is set to [Human]. If [Right Eye] or [Left Eye] is selected, only the selected eye is detected.

[Auto]: The camera detects eyes automatically.

[Right Eye]: The right eye of the subject (the eye on the left side from the photographer's perspective) is detected.

[Left Eye]: The left eye of the subject (the eye on the right side from the photographer's perspective) is detected.

Face/Eye Frame Display: Sets whether or not to display the face/eye detection frame when a human face or eyes are detected. ([On]/[Off])

Animal Eye Display: Sets whether or not to display the eye detection frame when the eye of an animal is detected. ([On]/[Off])

Face detection frame

When the product detects a face, the gray face detection frame appears. When the product determines that autofocus is enabled, the face detection frame turns white.

In case you have registered the priority order for each face using [Face Registration], the product automatically selects the first prioritized face and the face detection frame over that face turns white. The face detection frames of other registered faces turn reddish-purple.

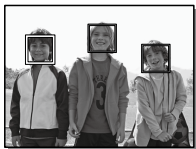

Eye detection frame

A white eye detection frame appears when an eye is detected and the camera determines that autofocus is possible, depending on the settings.



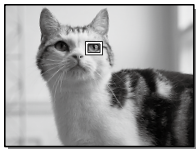

The eye detection frame is displayed as illustrated when [Subject Detection] is set to [Animal].



■ [Eye AF] by custom key

The Eye AF function can also be used by assigning [Eye AF] to a custom key. The camera can focus on human eyes as long as you are pressing the key. This is useful when you want to temporarily apply the Eye AF function to the entire screen regardless of the setting for [Focus Area]. The camera does not focus automatically if no faces or eyes are detected.

(Note: When you try to focus on eyes by pressing the shutter button halfway down, the camera only detects faces or eyes inside the focus area designated with [Focus Area]. If the camera detects no faces or eyes, it performs normal auto-focusing.)

- ① **MENU** →  2 (Camera Settings 2) →  Custom Key] or  Custom Key] → desired key, then assign the [Eye AF] function to the key.
- ② **MENU** →  1 (Camera Settings 1) → [Face/Eye AF Set.] → [Subject Detection] → desired setting.
- ③ **Point the camera at the face of a human or animal, and press the key to which you have assigned the [Eye AF] function.**

To shoot a still image, press the shutter button while pressing the key.

■ [Switch Right/Left Eye] by custom key

When [Subject Detection] is set to [Human] and [Right/Left Eye Select] is set to [Right Eye] or [Left Eye], you can switch the eye to be detected by pressing the custom key to which you have assigned the [Switch Right/Left Eye] function.

When [Right/Left Eye Select] is set to [Auto], you can temporarily switch the eye to be detected by pressing the custom key to which you have assigned the [Switch Right/Left Eye] function.

The temporary left/right selection is cancelled when you perform the following operations, etc. The camera returns to automatic eye detection.

- Pressing the center of the control wheel
- Pressing the center of the multi-selector
- Stopping pressing the shutter button halfway down (only during still image shooting)
- Stopping pressing the custom key to which [AF On] or [Eye AF] is assigned (only during still image shooting)
- Pressing the MENU button

Hint

- When [Right/Left Eye Select] is not set to [Auto], or you execute [Switch Right/Left Eye] using the custom key, the eye detection frame appears. Even when [Right/Left Eye Select] is set to [Auto], if [Face/Eye Frame Display] is set to [On], the eye detection frame will appear over detected eyes during movie shooting.
- If you want the face or eye detection frame to disappear within a certain period of time after the camera has focused on the face or eye, set [AF Area Auto Clear] to [On].

Note

- When [Subject Detection] is set to [Human], the eyes of animals are not detected. When [Subject Detection] is set to [Animal], human faces are not detected.
- When [Subject Detection] is set to [Animal], the following functions cannot be used.
 - Right/Left Eye Select
 - Face Priority in Multi Metering
 - Regist. Faces Priority
- The [Eye AF] function may not function very well in the following situations:
 - When the person is wearing sunglasses.
 - When the front hair covers the person's eyes.
 - In low-light or back-lit conditions.
 - When the eyes are closed.
 - When the person is in the shade.
 - When the person is out of focus.
 - When the person is moving too much.
- If the subject is moving too much, the detection frame may not be displayed correctly over their eyes.
- Depending on the circumstances, the eyes cannot be focused.
- When the camera cannot focus on human eyes, it will detect and focus on the face instead. The camera cannot focus on eyes when no human faces are detected.
- The product may not detect faces at all or may accidentally detect other objects as faces in some conditions.
- When recording movies with [Subject Detection] set to [Animal], you cannot use the eye detection function.
- The eye detection frame is not displayed when the Eye AF function is unavailable.

- You cannot use the face/eye detection function with the following functions:
 - Zoom functions other than the optical zoom.
 - [Posterization] under [Picture Effect]
 - Focus Magnifier
 - Movie shooting with [Record Setting] set to [120p]/[100p]
 - When [S&Q Frame Rate] is set to [120fps]/[100fps] during slow-motion/quick-motion shooting.
 - When [File Format] is set to [XAVC S 4K], [Record Setting] is set to [30p 100M]/[25p 100M] or [30p 60M]/[25p 60M], and [4K Output Select] is set to [Memory Card+HDMI]
- Up to 8 faces of your subjects can be detected.
- Even if [Face/Eye Frame Display] or [Animal Eye Display] is set to [Off], a green focusing frame will be displayed over faces or eyes that are in focus.
- When the shooting mode is set to [Intelligent Auto], [Face/Eye Priority in AF] is locked to [On].
- To detect animal eyes, arrange the composition so that both eyes and the nose of the animal are within the angle of view. Once you focus on the animal's face, the animal's eyes will be detected more easily.
- Even when [Subject Detection] is set to [Animal], the eyes of some types of animals cannot be detected.

Tracking subject (Tracking function)

This camera has the function of tracking which tracks the subject, and keeps marking it with the focusing frame.

You can set the start position to track by selecting from focusing areas, or by specifying by touch operation. The required function varies depending on the setting method.

Setting the start position to track by focusing area ([Tracking] under [Focus Area])

The selected focusing frame is set as the start position to track, and the tracking starts by pressing the shutter button halfway down (page 49).

- This function is available in still image shooting mode.
- This function is available when [Focus Mode] is set to [Continuous AF].
- When [Face/Eye Priority in AF] under [Face/Eye AF Set.] is set to [On], if the camera detects a face/eye, it will track that face or eye.

■ Setting the start position to track by touch operation ([Touch Tracking] under [Func. of Touch Operation])

You can set the subject to track by touching it on the monitor (page 95).

- This function is available in still image shooting mode and movie shooting mode.
- This function is available when [Focus Mode] is set to [Single-shot AF], [Continuous AF], or [DMF].

■ Changing the setting for [Focus Area] to [Tracking] temporarily ([Tracking On] under [🔑 Custom Key])

Even [Focus Area] is set to other than [Tracking], you can temporarily change the setting for [Focus Area] to [Tracking] while pressing and holding the key to which you have assigned [Tracking On] function.

- Assign the [Tracking On] function to a desired key using [🔑 Custom Key] in advance (page 179).
- This function is available in still image shooting mode.
- This function is available when [Focus Mode] is set to [Continuous AF].

Registering the current focus area (🔑 AF Area Registration)

You can move the focusing frame to a preassigned position temporarily using a custom key. This function is useful when shooting scenes in which the subject's movements are predictable; for example, sports scenes. With this function, you can switch the focus area quickly according to the situation.

■ How to register a focus area

- ① MENU → 📷 1 (Camera Settings 1) → [🔑 AF Area Registration] → [On].
- ② Set the focus area to the desired position and then hold down the Fn (Function) button.

How to call up the registered focus area

- ① **MENU** → 2 (Camera Settings 2) → [Custom Key] → desired key, then select [Regist. AF Area hold].
- ② Set the camera to the shooting mode, hold down the key to which [Regist. AF Area hold] has been assigned and then press the shutter button to shoot images.

Hint

- When a focusing frame is registered using [AF Area Registration], the registered focusing frame flashes on the monitor.
- If you assign [Regist AF Area toggle] to a custom key, you can use the registered focusing frame without holding down the key.
- If [Reg. AF Area + AF On] is assigned to a custom key, auto focusing using the registered focusing frame is performed when the key is pressed.

Note

- A focus area cannot be registered in the following situations:
 - The mode dial is set to either (Movie) or **S&Q**
 - While [Touch Focus] is being performed
 - While using the digital zoom function
 - While [Touch Tracking] is being performed
 - While focusing
 - While performing focus lock
- You cannot assign [Regist. AF Area hold] to [Left Button], [Right Button], or [Down Button].
- You cannot call up the registered focus area in the following situations:
 - The mode dial is set to either **AUTO** (Auto Mode), (Movie) or **S&Q**
- When [AF Area Registration] is set to [On], the [Lock Operation Parts] setting is locked to [Off].

Focus Frame Color

You can specify the color of the frame indicating the focusing area. If the frame is difficult to see because of the subject, make it more visible by changing its color.

MENU → 1 (Camera Settings 1) → **[Focus Frame Color]** → **desired color.**

White: Displays the frame indicating the focusing area in white.

Red: Displays the frame indicating the focusing area in red.

AF Illuminator

The AF illuminator supplies fill light to focus more easily on a subject in dark surroundings. In the time between pressing the shutter button halfway down and locking the focus, the AF illuminator lights up to allow the camera to focus easily.

MENU → 1 (Camera Settings 1) → **[ AF Illuminator]** → **desired setting.**

Auto: The AF illuminator lights up automatically in dark surroundings.

Off: Does not use the AF illuminator.

Note

- You cannot use [ AF Illuminator] in the following situations:
 - When the shooting mode is [Movie] or [S&Q Motion].
 - When the focus mode is set to [Continuous AF].
 - When [Focus Magnifier] is activated (page 69).
 - When a Mount Adaptor is attached.
- If the Multi Interface Shoe is equipped with a flash with an AF illuminator function, when the flash is turned on, the AF illuminator will turn on as well.
- The AF illuminator emits a very bright light. Although there is no health hazard, do not look directly into the AF illuminator at close range.

Circ. of Focus Point

Sets whether to allow the focusing frame to jump from one end to the other when you move the focusing frame with [Focus Area] set to [Zone], [Flexible Spot], [Expand Flexible Spot], [Tracking: Zone], [Tracking: Flexible Spot] or [Tracking: Expand Flexible Spot]. This function is useful when you want to move the focusing frame from one end to the other quickly.

MENU →  1 (Camera Settings 1) → [Circ. of Focus Point] → desired setting.

Does Not Circulate: The cursor does not move when you try to move the focusing frame past the end.

Circulate: The cursor jumps to the opposite end when you try to move the focusing frame past the end.

When [Circulate] is selected:

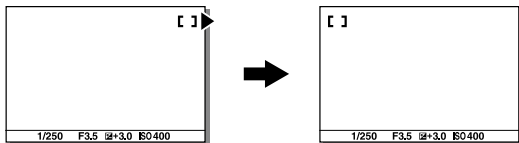

Note

- Even if you set [Circ. of Focus Point] to [Circulate], the focusing frame will not circulate diagonally.

AF Micro Adj.

Allows you to adjust the auto-focusing position and register an adjusted value for each lens when using A-mount lenses with an LA-EA2 or LA-EA4 Mount Adaptor (sold separately).

Use this function only when adjustments are needed. Note that the auto focus function may not be performed at a proper position when using this adjustment.

1 MENU →  **1 (Camera Settings 1)** → **[AF Micro Adj.]**.

2 Select [AF Adjustment Set.] → **[On]**.

3 [amount] → **desired value.**

- The larger the value you select, the farther the autofocused position will be from the product. The smaller the value you select, the closer the autofocused position will be to the product.
-

Hint

- It is recommended that you adjust the position under actual shooting conditions. Set [Focus Area] to [Flexible Spot] and use a bright subject with high contrast when you adjust.

Note

- When you attach a lens for which you have already registered a value, the registered value appears on the screen. [±0] appears for lenses for which a value has not yet been registered.
- If [-] is displayed as the value, then a total of 30 lenses have been registered and no new lens can be registered. To register a new lens, attach a lens for which the registration can be erased, and set its value to [±0], or reset the values of all the lenses using [Clear].
- The [AF Micro Adj.] supports Sony, Minolta, or Konica-Minolta lenses. If you perform [AF Micro Adj.] with lenses other than the supported lenses, the registered settings for the supported lenses may be affected. Do not perform [AF Micro Adj.] with an unsupported lens.
- You cannot set [AF Micro Adj.] individually for a Sony, Minolta, and Konica-Minolta lens of the same specification.

Aperture Drive in AF

Changes the aperture drive system to prioritize the auto-focusing tracking performance or to prioritize silence.

MENU →  **1 (Camera Settings 1)** → **[Aperture Drive in AF]** → **desired setting.**

Focus Priority: Changes the aperture drive system to prioritize auto-focusing performance.

Standard: Uses the standard aperture drive system.

Silent Priority: Changes the aperture drive system to prioritize silence so that the sound from the aperture drive is quieter than in [Standard].

Note

- When [Focus Priority] is selected, sound from the aperture drive may be audible, or the aperture effect may not be visible on the monitor. Also, the continuous shooting speed may become slower or the screen may flicker. To avoid these phenomena, change the setting to [Standard].
- When [Silent Priority] is selected, the focusing speed may become slower, and it may be more difficult to focus on a subject.
- Focus during continuous shooting is locked to the setting of the first shot when the parameter for [Aperture Drive in AF] is set to [Standard] or [Silent Priority], and the F-value is greater than F16.
- The effect may differ depending on the lens you use and the shooting conditions.

Manual Focus

When it is difficult to focus properly in the autofocus mode, you can adjust the focus manually.

- 1 Turn the focus mode dial while pressing the focus mode dial lock release button and select MF.**

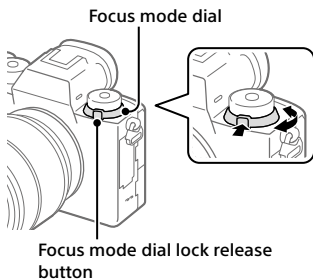

- 2 Rotate the focusing ring to achieve sharp focus.**

- When you rotate the focusing ring, the focus distance is displayed on the screen. The focus distance is not displayed when the Mount Adaptor (sold separately) is attached.

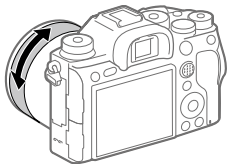

- 3 Press the shutter button fully down to shoot an image.**

Note

- When you use the viewfinder, adjust the diopter level to obtain the correct focus on the viewfinder (page 18).
- The displayed focus distance is just a reference.

Direct manual focus (DMF)

You can make fine adjustments manually after performing auto focusing, letting you focus on a subject more quickly than when using the manual focus from the beginning. This is convenient in situations such as macro shooting.

- 1 Turn the focus mode dial while pressing the focus mode dial lock release button and select DMF.**

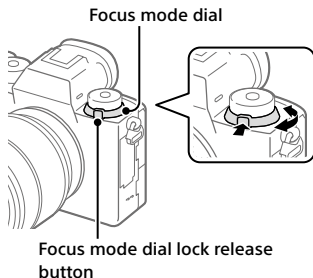

- 2 Press the shutter button halfway down to focus automatically.**

- 3 Keep the shutter button pressed halfway down, and then rotate the focusing ring to achieve a sharper focus.**

- When you rotate the focusing ring, the focus distance is displayed on the screen. The focus distance is not displayed when the Mount Adaptor (sold separately) is attached.

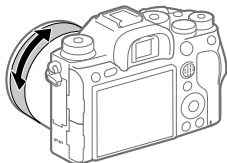



- 4 Press the shutter button fully down to shoot an image.**

Focus Magnifier







You can check the focus by enlarging the image before shooting. Unlike with  MF Assist], you can magnify the image without operating the focus ring.

1 MENU → 1 (Camera Settings 1) → [Focus Magnifier].

2 Press the center of the multi-selector to enlarge the image and select the area you want to enlarge by pressing the multi-selector up/down/left/right.

- Each time you press the center, the magnification scale will change.
- You can set the initial magnification by selecting MENU → 1 (Camera Settings 1) →  Initial Focus Mag.].

3 Confirm the focus.

- Press the  (Delete) button to bring the magnified position into the center of an image.
- When the focus mode is [Manual Focus], you can adjust the focus while an image is magnified. If  AF in Focus Mag.] is set to [Off], the [Focus Magnifier] function is canceled when the shutter button is pressed halfway down.
- When the shutter button is pressed halfway down while an image is magnified during the auto-focusing, different functions are performed depending on the  AF in Focus Mag.] setting.
 - When  AF in Focus Mag.] is set to [On]:
Auto-focusing is performed again.
 - When  AF in Focus Mag.] is set to [Off]:
The [Focus Magnifier] function is canceled.
- You can set how long the image is to be shown magnified by selecting MENU → 1 (Camera Settings 1) → [Focus Magnif. Time].

4 Press the shutter button fully down to shoot the image.

■ To use the focus magnifier function by touch operation

You can magnify the image and adjust the focus by touching the monitor. Set [Touch Operation] to [On] beforehand. Then, select the appropriate settings under [Touch Panel/Pad]. When the focus mode is [Manual Focus], you can perform [Focus Magnifier] by double-tapping the area to focus on while shooting with the monitor.

While shooting with the viewfinder, a frame is displayed in the center of the monitor by double-tapping and you can move the frame by dragging it. The image is magnified by pressing the center of the multi-selector.

Hint

- While using the focus magnifier function, you can move the magnified area by dragging it on the touch panel.
- To exit the focus magnifier function, double-tap the monitor again. When [AF in Focus Mag.] is set to [Off], the focus magnifier function is ended by pressing the shutter button halfway down.

MF Assist

Enlarges the image on the screen automatically to make manual focusing easier. This works in Manual Focus or Direct Manual Focus shooting.

1 MENU →  1 (Camera Settings 1) →  MF Assist] → [On].



2 Turn the focus ring to adjust the focus.

- The image is enlarged. You can magnify images further by pressing the center of the control wheel.
-

Hint

- You can set how long the image is to be shown magnified by selecting MENU →  1 (Camera Settings 1) → [Focus Magnif. Time].



Note

- You cannot use  MF Assist] when shooting movies. Use the [Focus Magnifier] function instead.
-  MF Assist] is not available when a Mount Adaptor is attached. Use the [Focus Magnifier] function instead.

Shutter setting

Shutter Type

You can set whether to shoot with a mechanical shutter or an electronic shutter.

MENU →  2 (Camera Settings 2) →  Shutter Type] → desired setting.

Auto: The shutter type is automatically switched based on the shooting conditions and shutter speed.





Mechanical Shutter: Shoot with the mechanical shutter only.

Electronic Shutter: Shoot with the electronic shutter only.

Hint

- In the following situations, set the  Shutter Type] to [Auto] or [Electronic Shutter].
 - When shooting with a high-speed shutter in a bright environment such as outside in bright sunlight, the beach, or snowy mountains.
 - When you want to increase the speed of continuous shooting.

Note

- In rare cases, the shutter sound may be produced when the power is turned off even if the  Shutter Type] is set to [Electronic Shutter]. However, this is not a malfunction.
- In the following situations, the mechanical shutter will be activated even if the  Shutter Type] is set to [Electronic Shutter].
 - When capturing a standard white color for the custom white balance
 - [Face Registration]
- The following functions are unavailable when the  Shutter Type] is set to [Electronic Shutter].
 - Flash shooting
 -  Long Exposure NR
 - Bulb shooting





Using the electronic shutter

Using the electronic shutter lets you perform various kinds of shooting that are difficult to achieve using the mechanical shutter, such as shooting without sounds or shaking, shooting with a super-fast shutter, and blackout-free shooting*.

* During blackout-free shooting, the screen does not black out or drop frames and you can keep looking at the subject through the viewfinder or monitor while shooting images.

Shutter types and camera performance



The camera's shutter speed range, shutter sound, occurrence of blackout, and availability of the anti-flicker shooting or the flash for each setting are as follows:

	 Shutter Type		
	 Auto	 Mechanical Shutter	 Electronic Shutter
Shutter speed	Single shooting: BULB – 1/32000 ^{*1*2} Continuous shooting: 1/8 – 1/32000 ^{*1*2}	Single shooting: BULB – 1/8000 Continuous shooting: 30 – 1/8000	Single shooting: 30 – 1/32000 ^{*1*2} Continuous shooting: 1/8 – 1/32000 ^{*1*2}
Shutter sound	Single shooting: Mechanical shutter sound Continuous shooting: Electronic shutter sound	Mechanical shutter sound	Electronic shutter sound
Blackout	Single shooting: Occurs Continuous shooting: Blackout-free ^{*3}	Occurs	Blackout-free ^{*3}
Flash	Available ^{*4}	Available	Unavailable
Anti-flicker shooting	Available ^{*5}	Available	Unavailable

- *1 The maximum shutter speed is 1/16000 second when the shooting mode is not set to S (Shutter Priority) or M (Manual Exposure), or during bracket shooting with a setting other than [WB bracket] or [DRO Bracket].
- *2 The next value after 1/16000 second is 1/32000 second when the shooting mode is set to S (Shutter Priority) or M (Manual Exposure).
- *3 When [Shoot. Start Disp.] is set to [On], blackout occurs only when the first image is shot (page 76).
- *4 The maximum shutter speed is 1/8000 second when performing continuous shooting with the flash.
- *5 The maximum shutter speed is 1/8000 second when [ Anti-flicker Shoot.] is set to [On].



■ Advanced shooting using the electronic shutter: Shooting without shutter sound



You can use the electronic shutter to shoot without shutter sound.

- ① **MENU** →  **2 (Camera Settings 2)** → [ **Shutter Type**] → [**Electronic Shutter**].
 - Select [Electronic Shutter] or [Auto] for continuous shooting.
- ② **MENU** →  **2 (Camera Settings 2)** → [**Audio signals**] → [**Off**] or [**On: other than e-shut.**].

■ Advanced shooting using the electronic shutter: Blackout-free continuous shooting

You can use the electronic shutter to perform continuous shooting with focus and exposure tracking, without the screen blacking out.

- ① **MENU** →  **2 (Camera Settings 2)** → [ **Shutter Type**] → [**Auto**] or [**Electronic Shutter**].
- ② **Turn the mode dial and select P (Program Auto), A (Aperture Priority), S (Shutter Priority), or M (Manual Exposure), then set the shutter speed and aperture value. (For example: shutter speed of 1/250 second and aperture value of F2.8)**
 - The product will not adjust the exposure in manual exposure mode when [ISO] is set to other than [ISO AUTO].

- ③ Turn the drive mode dial and select  H (Continuous Shooting: Hi),  M (Continuous Shooting: Mid), or  L (Continuous Shooting: Lo).
- ④ Turn the focus mode dial and select AF-C (Continuous AF), then start shooting images.

Hint

- If you want to display the timing of shooting on the screen during blackout-free shooting, adjust the setting using MENU →  2 (Camera Settings 2) → [Shoot. Timing Disp.].
- To take advantage of the performance of the camera, we recommend that you use a UHS-II memory card.

Note

- When shooting without the shutter sound, do so on your own responsibility, with sufficient consideration to the privacy and portrait rights of the subject.
- Even if you set the camera to shoot without the shutter sound, it will not be completely silent.
- Even if you set the camera to shoot without the shutter sound, the aperture and focus will make sounds.
- When using a lens compatible with Aperture Drive in AF, sound from the aperture drive may be audible during continuous shooting if [Aperture Drive in AF] is set to [Focus Priority].
- If you set [Audio signals] to [Off], the camera will not beep when the subject comes into focus or when the self-timer is in operation.
- During blackout-free shooting, the slower the shutter speed, the lower the refresh rate of the screen. If you want the screen display to be smooth in order to track the subject, set a shutter speed faster than 1/125 second.
- The electronic shutter operates differently when a Mount Adaptor is attached to the camera.

Displaying the release timing (Shoot. Timing Disp.)

Sets whether or not to display marks (such as a frame) on the screen while shooting. This function is useful in situations where it is difficult to determine the timing of shooting just by looking at the screen, such as when the shutter sound is turned off.

MENU →  **2 (Camera Settings 2)** → **[Shoot. Timing Disp.]** → **desired setting.**

On: Type 1: Displays a frame (dark color) around the focusing frame.

On: Type 2: Displays a frame (light color) around the focusing frame.

On: Type 3: Displays ■ (dark color) in the four corners of the screen.

On: Type 4: Displays ■ (light color) in the four corners of the screen.

Off: Does not display the shutter release timing during blackout-free shooting.

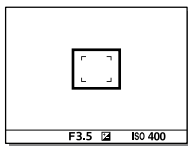

[On: Type 1]/[On: Type 2]

(Example: [Focus Area] is set to [Center])

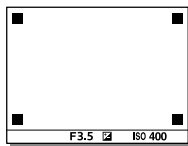

[On: Type 3]/[On: Type 4]

Shoot. Start Disp.

Sets whether or not to indicate the shutter release timing with a black screen during blackout-free shooting. The black screen makes it easier to visually confirm when the shutter is released.

MENU →  **2 (Camera Settings 2)** → **[Shoot. Start Disp.]** → **desired setting.**



On: The screen blacks out when shooting the first image during blackout-free shooting.

Off: The screen does not black out when shooting the first image during blackout-free shooting.

Anti-flicker Shoot.

Detects flickering/blinking from artificial light sources such as fluorescent lighting and times the shooting of images to moments when flickering will have less of an impact.

This function reduces differences in the exposure and color tone caused by flickering between the upper area and the lower area of an image shot with fast shutter speed and during continuous shooting.

1 MENU →  **1 (Camera Settings 1)** → **[ Anti-flicker Shoot.]** → **[On].**

Off: Does not reduce influences caused by flickering.

On: Reduces influences caused by flickering. When the camera detects flickering while the shutter button is pressed halfway down, **Flicker** (flicker icon) will be displayed.





2 Press the shutter button halfway down, and then shoot the image.

- The product detects flickering when the shutter button is pressed halfway down.
-

Hint

- The color tone of the shot result may vary when you shoot the same scene using a different shutter speed. If that happens, we recommend that you shoot in [Shutter Priority] or [Manual Exposure] mode with a fixed shutter speed.
- You can perform anti-flicker shooting by pressing the AF-ON (AF On) button.
- You can perform anti-flicker shooting by pressing the shutter button halfway down or pressing the AF-ON (AF On) button, even when in the manual focus mode.

Note

- When you set [ Anti-flicker Shoot.] to [On], the shutter release lag may increase slightly. In the continuous shooting mode, the shooting speed may slow down or the interval between shots may become irregular.
- The camera detects flickering when the frequency of the light source is 100 Hz or 120 Hz only.
- The camera cannot detect flickering depending on the light source and shooting conditions, such as a dark background.
- Even if the camera detects flickering, the influences caused by flickering may not be reduced enough depending on the light source or the shooting situation. We recommend that you take test shots beforehand.
- [ Anti-flicker Shoot.] is not available when shooting in the following situations:
 - While bulb shooting
 - Movie shooting mode
 - When [ Shutter Type] is set to [Electronic Shutter], or [ Shutter Type] is set to [Auto] and [Drive Mode] is set to [Cont. Shooting]
- The color tone of the shot results may differ depending on the setting of [ Anti-flicker Shoot.].

e-Front Curtain Shutter

The electronic front curtain shutter function shortens the time lag between when the shutter button is pressed and the shutter is released. You can use [e-Front Curtain Shutter] when [Shutter Type] is set to [Mechanical Shutter].

MENU →  **2 (Camera Settings 2)** → **[e-Front Curtain Shutter]** → **desired setting.**

On: Uses the electronic front curtain shutter function.

Off: Does not use the electronic front curtain shutter function.

Note

- When you shoot at high shutter speeds with a large-aperture lens attached, out-of-focus circle produced by the bokeh effect may get cut off because of the shutter mechanism. If this happens, set [e-Front Curtain Shutter] to [Off].
- When a lens made by another manufacturer (including a Minolta/Konica-Minolta lens) is used, set this function to [Off]. If you set this function to [On], the correct exposure will not be set or the image brightness will be uneven.
- When you shoot at high shutter speeds, the image brightness may become uneven depending on the shooting environment. In such cases, set [e-Front Curtain Shutter] to [Off].

Shooting with drive modes (continuous shooting/self-timer)



Select the appropriate mode for the subject, such as single shooting, continuous shooting or bracketing shooting.

Select the desired drive mode by turning the drive mode dial.

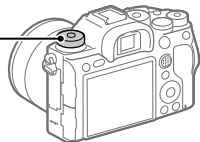
- Turn the drive mode dial while holding down the drive mode dial lock release button.



Single Shooting: Normal shooting mode.

   **Cont. Shooting:** Shoots images continuously while you press and hold down the shutter button.

 **Self-timer:** Shoots an image using the self-timer after a designated number of seconds have elapsed since the shutter button was pressed.



BRK Bracket: Shoots images using the bracketing function. The type of bracketing function can be set by selecting MENU →  1 (Camera Settings 1) → [Bracket Settings] → [Bracket Type].

Continuous shooting

Shoots images continuously while you press and hold down the shutter button.

Turn the drive mode dial and select the desired mode.

- Turn the drive mode dial while pressing the drive mode dial lock release button.

 **H Continuous Shooting: Hi** /  **M Continuous Shooting: Mid** /
 **L Continuous Shooting: Lo**

	 Shutter Type	
	Mechanical Shutter	Auto/Electronic Shutter ^{*1}
Continuous Shooting: Hi	10 images per second at maximum ^{*2}	20 images per second at maximum ^{*2*3*4}
Continuous Shooting: Mid	8 images per second at maximum ^{*2}	10 images per second at maximum ^{*2}
Continuous Shooting: Lo	3 images per second at maximum	5 images per second at maximum ^{*2}

- ^{*1} The value shown is the shooting speed when [Aperture Drive in AF] is set to [Standard]. When [Aperture Drive in AF] is set to [Focus Priority], the speed of continuous shooting may become slower.
- ^{*2} The focus is locked to the setting in the first shot when [Aperture Drive in AF] is set to [Standard] or [Silent Priority], and the F-value is greater than F16.
- ^{*3} When the Focus Mode is set to AF-C (Continuous AF), the speed of continuous shooting varies depending on the attached lens. For details, check the support page on compatible lenses.
- ^{*4} During uncompressed RAW shooting, 12 images are shot per second at maximum.

Hint

- To continuously adjust the focus and exposure during continuous shooting, set as follows:
 - [Focus Mode]: [Continuous AF]
 - [ AEL w/ shutter]: [Off] or [Auto]

Note

- The shooting speed during continuous shooting becomes slower when [RAW File Type] is set to [Uncompressed].
- Continuous shooting is unavailable in the following situations:
 - [Picture Effect] is set to [Rich-tone Mono.].
 - [DRO/Auto HDR] is set to [Auto HDR].
- The speed of continuous shooting decreases when you shoot with a flash.

■ Displaying continuous shooting remaining time indicator (Cont. Shoot. Length)

Sets whether to display an indicator of the remaining time for which continuous shooting can be performed at the same shooting speed.

MENU →  **2 (Camera Settings 2)** → **[Cont. Shoot. Length]** → **desired setting.**

Always Display: Always displays the indicator when the drive mode is set to [Cont. Shooting].

Shoot.-Only Display: Displays the indicator only while continuous shooting is performed.

Not Displayed: Does not display the indicator.

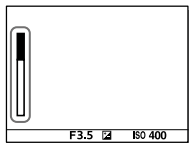

Hint

- When the internal camera memory for buffering is full, "SLOW" will be displayed and the continuous shooting speed will decrease.

Self-timer

Shoots an image using the self-timer after a designated number of seconds have elapsed since the shutter button was pressed. Use the 5-second/10-second self-timer when you are going to be in the picture, and use the 2-second self-timer to reduce camera-shake caused by pressing the shutter button.

1 Select (Self-timer) by turning the drive mode dial.

- Turn the drive mode dial while holding down the drive mode dial lock release button.

2 MENU → 1 (Camera Settings 1) → [Self-timer Type] → [Self-timer (Single)] → desired mode.

The mode determines the number of seconds until a picture is taken after the shutter button is pressed.

- The setting screen for [Self-timer Type] can be displayed by pressing the Fn button.

10 Self-timer (Single): 10 sec



5 Self-timer (Single): 5 sec

2 Self-timer (Single): 2 sec

3 Adjust the focus and shoot the image.

The self-timer lamp flashes, a beep sounds, and a picture is taken after the designated number of seconds have elapsed.

Hint

- Press the shutter button again to stop the count of the self-timer.
- Select a drive mode other than  (Self-timer) by turning the drive mode dial to cancel the self-timer.
- Set [Audio signals] to [Off] to turn off the beeping sound during the self-timer countdown.
- To use the self-timer in bracket mode, select BRK (Bracket) by turning the drive mode dial, then select MENU →  1 (Camera Settings 1) → [Bracket Settings] → [Selftimer during Bracket].

Self-timer (Cont)

Shoots a designated number of images using the self-timer after a designated number of seconds have elapsed since the shutter button was pressed. You can choose the best from multiple shots.

1 Select (Self-timer) by turning the drive mode dial.

- Turn the drive mode dial while holding down the drive mode dial lock release button.

2 MENU → 1 (Camera Settings 1) → [Self-timer Type] → [Self-timer (Cont)] → desired mode.

For example, three images are shot when 10 seconds have elapsed after the shutter button is pressed when [Self-timer (Cont.): 10 Sec. 3 Img.] is selected.

- The setting screen for [Self-timer Type] can be displayed by pressing the Fn button.

 ¹⁰/₃ Self-timer (Cont.): 10 Sec. 3 Img.

 ¹⁰/₅ Self-timer (Cont.): 10 Sec. 5 Img.

 ⁵/₃ Self-timer (Cont.): 5 Sec. 3 Img.

 ⁵/₅ Self-timer (Cont.): 5 Sec. 5 Img.

 ²/₃ Self-timer (Cont.): 2 Sec. 3 Img.

 ²/₅ Self-timer (Cont.): 2 Sec. 5 Img.

3 Adjust the focus and shoot the image.

The self-timer lamp flashes, a beep sounds, and pictures are taken after the designated number of seconds has elapsed. The designated number of pictures are taken continuously.

Hint

- Press the shutter button again to stop the count of the self-timer.
- Select a drive mode other than  (Self-timer) by turning the drive mode dial to cancel the self-timer.

Cont. Bracket

Shoots multiple images while automatically shifting the exposure from base to darker and then to lighter. You can select an image that suits your purpose after recording.

1 Select BRK (Bracket) by turning the drive mode dial.

- Turn the drive mode dial while holding down the drive mode dial lock release button.

2 MENU → 1 (Camera Settings 1) → [Bracket Settings] → [Bracket Type] → [Cont. Bracket] → desired mode.

For example, the camera shoots a total of three images continuously with an exposure value shifted by plus or minus 0.3 EV when [Cont. Bracket: 0.3EV 3 Image] is selected.

- The setting screen for [Bracket Type] can be displayed by pressing the Fn button.

3 Adjust the focus and shoot the image.

- The base exposure is set at the first shot.
- Keep pressing and holding the shutter button until bracket shooting is finished.

Note

- The last shot is shown on the auto review.
- When [ISO AUTO] is selected in [Manual Exposure] mode, the exposure is changed by adjusting the ISO value. If a setting other than [ISO AUTO] is selected, the exposure is changed by adjusting the shutter speed.
- When the exposure is compensated, the exposure is shifted based on the compensated value.
- Bracket shooting is unavailable in the following shooting modes:
 - [Intelligent Auto]
- When the flash is used, the product performs flash bracket shooting, which shifts the amount of flash light even if [Cont. Bracket] is selected. Press the shutter button for each image.

Single Bracket

Shoots multiple images while automatically shifting the exposure from base to darker and then to lighter. You can select the image that suits your purpose after recording.

Since a single picture is taken each time you press the shutter button, you can adjust the focus or the composition for each shot.

1 Select BRK (Bracket) by turning the drive mode dial.

- Turn the drive mode dial while holding down the drive mode dial lock release button.

2 MENU → 1 (Camera Settings 1) → [Bracket Settings] → [Bracket Type] → [Single Bracket] → desired mode.

For example, when [Single Bracket: 0.3EV 3 Image] is selected, three images are shot one at a time with the exposure value shifted up and down in increments of 0.3 EV.

- The setting screen for [Bracket Type] can be displayed by pressing the Fn button.



3 Adjust the focus and shoot the image.

- Press the shutter button for each image.

Note

- When [ISO AUTO] is selected in [Manual Exposure] mode, the exposure is changed by adjusting the ISO value. If a setting other than [ISO AUTO] is selected, the exposure is changed by adjusting the shutter speed.
- When the exposure is compensated, the exposure is shifted based on the compensated value.
- Bracket shooting is unavailable in the following situations:
 - [Intelligent Auto]

Indicator during bracket shooting

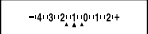
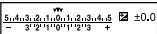
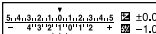
	Ambient light* bracketing 3 images shifted by 0.3 EV steps Exposure compensation ± 0.0 EV	Flash bracketing 3 images shifted by 0.7 EV steps Flash compensation -1.0 EV
Viewfinder		No indicator is displayed.
Monitor (Display All Info. or Histogram)		
Monitor (For viewfinder)	 (Upper indicator)	 (Lower indicator)

* Ambient light: A generic term for non-flash light including natural light, electric bulb and fluorescent lighting. Whereas the flash light blinks for a moment, ambient light is constant, so this kind of light is called "ambient light."

Note

- During bracket shooting, guides equal to the number of images to be shot are displayed over/under the bracket indicator.
- When you start single bracket shooting, the guides will disappear one by one as the camera records images.

WB bracket

Shoots a total of three images, each with different color tones according to the selected settings for white balance, color temperature and color filter.

1 Select BRK (Bracket) by turning the drive mode dial.

- Turn the drive mode dial while holding down the drive mode dial lock release button.

2 MENU → 1 (Camera Settings 1) → [Bracket Settings] → [Bracket Type] → [WB bracket] → desired mode.

- The setting screen for [Bracket Type] can be displayed by pressing the Fn button.

 White Balance Bracket: Lo: Records a series of three images with small changes in the white balance (within the range of 10MK⁻¹).

 White Balance Bracket: Hi: Records a series of three images with large changes in the white balance (within the range of 20MK⁻¹).

- * MK⁻¹ is the unit that indicates the capability of color temperature conversion filters and indicates the same value as "mired."

3 Adjust the focus and shoot the image.

Note

- The last shot is shown on the auto review.

DRO Bracket

You can record a total of three images, each at a different degree of D-Range Optimizer value.

1 Select BRK (Bracket) by turning the drive mode dial.

- Turn the drive mode dial while holding down the drive mode dial lock release button.

2 MENU → 1 (Camera Settings 1) → [Bracket Settings] → [Bracket Type] → [DRO Bracket] → desired mode.

- The setting screen for [Bracket Type] can be displayed by pressing the Fn button.



DRO Bracket: Lo: Records a series of three images with small changes in the D-Range Optimizer value (Lv 1, Lv 2, and Lv 3).



DRO Bracket: Hi: Records a series of three images with large changes in the D-Range Optimizer value (Lv 1, Lv 3, and Lv 5).

3 Adjust the focus and shoot the image.

Note

- The last shot is shown on the auto review.

Bracket Settings

You can set the type of bracket or the self-timer in bracket shooting mode, and the shooting order for exposure bracketing or white balance bracketing.

① **Select BRK (Bracket) by turning the drive mode dial.**

- Turn the drive mode dial while holding down the drive mode dial lock release button.

② **MENU** →  **1 (Camera Settings 1)** → **[Bracket Settings]** → **desired setting.**

Bracket Type: Sets the type of bracket shooting.

(Cont. Bracket / Single Bracket / WB bracket / DRO Bracket)

Selftimer during Bracket: Sets whether to use the self-timer during bracket shooting. Also sets the number of seconds until the shutter is released if using the self-timer.



(OFF/2 Sec/5 Sec/10 Sec)

Bracket order: Sets the order of exposure bracketing and white balance bracketing.

(0 → - → + / - → 0 → +)

Interval Shooting

You can automatically shoot a series of still images with the shooting interval and number of shots that you set in advance (Interval shooting). You can then create a movie from the still images produced by interval shooting using the computer software Imaging Edge (Viewer) (page 213). You cannot create a movie from the still images on the camera.

1 MENU →  **1 (Camera Settings 1)** →  **Interval Shoot Func.]**
→ **[Interval Shooting]** → **[On]**.

2 MENU →  **1 (Camera Settings 1)** →  **Interval Shoot Func.]**
→ **Select the item you want to set and the desired setting.**

Interval Shooting: Sets whether to perform interval shooting. ([On]/[Off])

Shooting Start Time: Sets the time from when you press the shutter button to when interval shooting starts. (1 second to 99 minutes 59 seconds)

Shooting Interval: Sets the shooting interval (time from when one exposure starts to when the exposure for the next shot starts). (1 second to 60 seconds)

Number of Shots: Sets the number of shots for interval shooting. (1 shot to 9999 shots)

AE Tracking Sensitivity: Sets the tracking sensitivity of the auto exposure against the change in luminance during interval shooting. If you select [Low], exposure changes during interval shooting will be smoother. ([High]/[Mid]/[Low])

Shutter Type in Interval: Sets the shutter type during interval shooting. ([Mechanical Shutter]/[Electronic Shutter])



Shoot Interval Priority: Sets whether or not to prioritize the shooting interval when the exposure mode is [Program Auto] or [Aperture Priority] and the shutter speed becomes longer than the time set for [Shooting Interval]. ([On]/[Off])

3 Press the shutter button.

When the time set for [Shooting Start Time] has elapsed, shooting will start.

- When the number of shots set for [Number of Shots] is completed, the camera will return to the standby screen for interval shooting.

Hint

- If you press the shutter button during interval shooting, interval shooting will end and the camera will return to the standby screen for interval shooting.
- To go back to the normal shooting mode, select MENU →  1 (Camera Settings 1) →  Interval Shoot Func.] → [Interval Shooting] → [Off].
- If you press a key to which one of the following functions has been assigned at the moment when shooting starts, the function will remain active during interval shooting even without you holding down the button.
 - [AEL hold]
 - [ AEL hold]
 - [AF/MF Control Hold]
 - [Regist. AF Area hold]
 - [AWB Lock Hold]
 - [My Dial 1 during Hold] to [My Dial 3 during Hold]
- If you set [Display as Group] to [On], still images shot with the interval shooting function will be displayed in groups.
- Still images shot with interval shooting can be played back continuously on the camera (page 165). If you intend to create a movie using the still images, you can preview the result.

Note

- You may not be able to record the set number of images depending on the remaining battery level and the amount of free space on the recording medium. Supply power via USB while shooting, and use a memory card with sufficient space.
- When the shooting interval is short, the camera may get hot easily. Depending on the ambient temperature, you may not be able to record the set number of images because the camera stops recording to protect the equipment.

- During interval shooting (including the time between pressing the shutter button and the start of shooting), you cannot operate the dedicated shooting setting screen or MENU screen. However, you can adjust some settings such as the shutter speed with using the customized dial or control wheel.
- During interval shooting, auto review is not displayed.
- [Shutter Type in Interval] is set to [Electronic Shutter] as a default, regardless of the setting for [📷 Shutter Type].
- Interval shooting is unavailable in the following situations:
 - The shooting mode is set to other than P/A/S/M

Using touch function

Touch Operation

Sets whether or not to activate touch operations on the monitor.

MENU →  (Setup) → [Touch Operation] → **desired setting.**

On: Activates the touch operation.

Off: Deactivates the touch operation.

Touch Panel/Pad

Touch operations when shooting with the monitor are referred to as “touch panel operations,” and touch operations when shooting with the viewfinder are referred to as “touch pad operations.” You can select whether to activate touch panel operations or touch pad operations.

MENU →  (Setup) → [Touch Panel/Pad] → **desired setting.**

Touch Panel+Pad: Activates both the touch panel operations when shooting with the monitor and touch pad operations when shooting with the viewfinder.

Touch Panel Only: Activates only the touch panel operations when shooting with the monitor.

Touch Pad Only: Activates only the touch pad operations when shooting with the viewfinder.

Touch Focus

[Touch Focus] allows you to specify a position where you want to focus using touch operations. This function is available when [Focus Area] is set to a parameter other than [Flexible Spot], [Expand Flexible Spot], [Tracking: Flexible Spot] or [Tracking: Expand Flexible Spot]. Select MENU →  (Setup) → [Touch Operation] → [On] beforehand.

MENU →  (Camera Settings 2) → [Func. of Touch Operation] → [Touch Focus].

■ Specifying the position where you want to focus in the still image mode

You can specify the position where you want to focus using touch operations. After touching the monitor and specifying a position, press the shutter button halfway down to focus.

① Touch the monitor.

- When shooting with the monitor, touch the position where you want to focus.
- When shooting with the viewfinder, you can move the position of the focus by touching and dragging on the monitor while looking through the viewfinder.

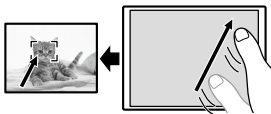

- To cancel focusing with touch operations, touch  or press the center of the control wheel if shooting with the monitor, and press the center of the control wheel if shooting with the viewfinder.

② Press the shutter button halfway down to focus.

- Press the shutter button all the way down to shoot images.

■ Specifying the position where you want to focus in the movie recording mode (spot focus)

The camera will focus on the touched subject. Spot focus is not available when shooting with the viewfinder.

Touch the subject on which you want to focus before or during recording.

- When you touch the subject, the focus mode temporarily switches to manual focus and the focus can be adjusted using the focus ring.
- To cancel spot focus, touch  or press the center of the control wheel.

Hint

- In addition to the touch focus function, touch operations such as the following are also available.
 - When [Focus Area] is set to [Flexible Spot], [Expand Flexible Spot], [Tracking: Flexible Spot], or [Tracking: Expand Flexible Spot], the focusing frame can be moved using touch operations.
 - When the [Focus Mode] is set to [Manual Focus], the focus magnifier can be used by double-tapping the monitor.

Note

- The touch focus function is not available in the following situations:
 - When [Focus Mode] is set to [Manual Focus]
 - When using the digital zoom
 - When using the LA-EA2 or LA-EA4 Mount Adaptor (sold separately)

Touch Tracking

You can use touch operations to select a subject you want to track in the still image and movie recording modes. Select MENU →  (Setup) → [Touch Operation] → [On] in advance.

- 1 MENU →  2 (Camera Settings 2) → [Func. of Touch Operation] → [Touch Tracking].

2 Touch the subject that you want to track on the monitor.

Tracking will start.

- When shooting with the viewfinder, you can use the touch pad to select a subject you want to track.

3 Press the shutter button halfway down to focus.

- Press the shutter button all the way down to shoot images.
-

Hint

- To cancel tracking, touch  or press the center of the control wheel.



Note

- [Touch Tracking] is unavailable in the following situations:
 - When shooting movies with  [Record Setting] set to [120p]/[100p].
 - When [Focus Mode] is set to [Manual Focus].
 - When using the Smart Zoom, Clear Image Zoom and Digital Zoom
 - When using the LA-EA2 or LA-EA4 Mount Adaptor (sold separately)

Selecting a still image size/image quality

File Format

Sets the file format for still images.



MENU →  1 (Camera Settings 1) → [ File Format] → desired setting.

RAW: Digital processing is not performed on this file format. Select this format to process images on a computer for professional purposes.

RAW & JPEG: A RAW image and a JPEG image are created at the same time. This is suitable when you need two image files, a JPEG for viewing, and a RAW for editing.

JPEG: The image is recorded in the JPEG format.

About RAW images

- To open a RAW image file recorded with this camera, the software Imaging Edge (page 213) is needed. With Imaging Edge, you can open a RAW image file, then convert it into a popular image format such as JPEG or TIFF, or readjust the white balance, saturation or contrast of the image.
- You cannot apply [Auto HDR] or [Picture Effect] functions with RAW images.
- RAW images recorded with this camera have a resolution of 14 bits per pixel. However, the resolution is limited to 12 bits in the following shooting modes:
 - [ Long Exposure NR]
 - [BULB]
 - Continuous shooting when [ RAW File Type] is set to [Compressed]
- You can set whether RAW images are compressed or uncompressed using [ RAW File Type].

Note

- If you do not intend to edit the images on your computer, we recommend that you record in JPEG format.
- You cannot add DPOF (print order) registration marks to RAW images.

RAW File Type



Selects the file type for RAW images.

MENU →  1 (Camera Settings 1) → [ RAW File Type] → **desired setting.**

Compressed: Records images in compressed RAW format. Records images in compressed RAW format. The file size of the image will be approximately half of that with [Uncompressed].



Uncompressed: Records images in uncompressed RAW format. When [Uncompressed] is selected for [ RAW File Type], the file size of the image will be larger than if it were recorded in compressed RAW format.

Note

- When [Uncompressed] is selected for [ RAW File Type], the icon on the screen switches to .  is also displayed while an image shot in uncompressed RAW format is played back.

JPEG Quality



Selects the JPEG image quality when [ File Format] is set to [RAW & JPEG] or [JPEG].

MENU →  1 (Camera Settings 1) → [ JPEG Quality] → **desired setting.**

Extra fine/Fine/Standard: Since the compression rate increases from [Extra fine] to [Fine] to [Standard], the file size decreases in the same order. This allows more files to be recorded on one memory card, but the image quality is lower.

JPEG Image Size

The larger the image size, the more detail will be reproduced when the image is printed on large-format paper. The smaller the image size, the more images can be recorded.

MENU →  1 (Camera Settings 1) → [ JPEG Image Size] → desired setting.

When recording in the full-frame size

When [ Aspect Ratio] is set to 3:2	
L: 24M	6000×4000 pixels
M: 10M	3936×2624 pixels
S: 6.0M	3008×2000 pixels

When [ Aspect Ratio] is set to 4:3	
L: 21M	5328×4000 pixels
M: 9.2M	3488×2624 pixels
S: 5.3M	2656×2000 pixels

When [ Aspect Ratio] is set to 16:9	
L: 20M	6000×3376 pixels
M: 8.7M	3936×2216 pixels
S: 5.1M	3008×1688 pixels

When [ Aspect Ratio] is set to 1:1	
L: 16M	4000×4000 pixels
M: 6.9M	2624×2624 pixels
S: 4.0M	2000×2000 pixels

When recording in the APS-C-equivalent size

When [ Aspect Ratio] is set to 3:2	
L: 10M	3936×2624 pixels
M: 6.0M	3008×2000 pixels
S: 2.6M	1968×1312 pixels

When [ Aspect Ratio] is set to 4:3	
L: 9.2M	3488×2624 pixels
M: 5.3M	2656×2000 pixels
S: 2.3M	1744×1312 pixels

When [ Aspect Ratio] is set to 16:9	
L: 8.7M	3936×2216 pixels
M: 5.1M	3008×1688 pixels
S: 2.2M	1968×1112 pixels

When [ Aspect Ratio] is set to 1:1	
L: 6.9M	2624×2624 pixels
M: 4.0M	2000×2000 pixels
S: 1.7M	1312×1312 pixels

Note

- When [📷 File Format] is set to [RAW] or [RAW & JPEG], the image size for RAW images corresponds to "L."

📷 Aspect Ratio

MENU → 📷1 (Camera Settings 1) → [📷 Aspect Ratio] → **desired setting.**

3:2: Same aspect ratio as 35 mm film

4:3: The aspect ratio is 4:3.

16:9: The aspect ratio is 16:9.

1:1: The horizontal and vertical ratio is equal.

APS-C/Super 35mm

Sets whether to record in APS-C-equivalent size for still images and in Super 35mm-equivalent size for movies. If you select [On] or [Auto], you can use an APS-C size dedicated lens on this product.

MENU → 📷1 (Camera Settings 1) → [APS-C/Super 35mm] → **desired setting.**

On: Records in either APS-C-equivalent size or Super 35mm-equivalent size.

Auto: Automatically sets the capture range according to the lens.

Off: Always captures 35mm full-frame image sensor pictures.

Note

- When you attach an APS-C compatible lens and set [APS-C/Super 35mm] to [Off], you may not achieve the desired shooting results.
- When you set [APS-C/Super 35mm] to [On], the angle of view will be the same as when shooting with an APS-C size image sensor.

Selecting a shooting mode

List of mode dial function

You can switch the shooting mode according to the subject or purpose of shooting.

Turn the mode dial to select the desired shooting mode.

- Turn the mode dial while pressing the mode dial lock release button in the center of the mode dial.

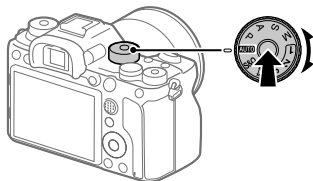

Available functions

i (Intelligent Auto)	Allows you to shoot with automatic scene recognition.
P (Program Auto)	Allows you to shoot with the exposure adjusted automatically (both the shutter speed and the aperture value (F value)). Also you can select various settings using the menu.
A (Aperture Priority)	Allows you to adjust the aperture and shoot when you want to blur the background, etc.
S (Shutter Priority)	Allows you to shoot fast-moving subjects etc., by manually adjusting the shutter speed.
M (Manual Exposure)	Allows you to shoot still images with the desired exposure by adjusting the exposure (both the shutter speed and the aperture value (F value)).
1/2/3 (Memory recall)	Allows you to shoot an image after recalling often-used modes or numeric settings registered in advance.
Movie (Movie)	Allows you to change the exposure mode for movie recording.
S&Q (S&Q Motion)	Allows you to shoot slow-motion and quick-motion movies.

AUTO (i📷 Intelligent Auto)

The camera shoots with automatic scene recognition.

1 Set the mode dial to **AUTO (Auto Mode).**

The shooting mode will be set to **i📷** (Intelligent Auto).

2 Point the camera at the subject.

When the camera recognized the scene, the icon for the recognized scene appears on the screen.



3 Adjust the focus and shoot the image.

Note

- The product will not recognize the scene when you shoot images with zoom functions other than optical zoom.
- The product may not properly recognize the scene under certain shooting conditions.
- For [Intelligent Auto] mode, most of the functions are set automatically, and you cannot adjust the settings on your own.

About Scene Recognition

Scene Recognition operates in [Intelligent Auto] mode. This function allows the product to automatically recognize the shooting conditions and shoot the image.

Scene Recognition

When the product recognizes certain scenes, the following icons and guides are displayed on the first line:

👤 (Portrait), 👶 (Infant), 🌙 (Night Portrait), 🌑 (Night Scene),
📷 (Backlight Portrait), 📷 (Backlight), 🏔️ (Landscape), 🌸 (Macro),
🔦 (Spotlight), 📷 (Low Light), 📷 (Night Scene using a tripod)

P Program Auto

Allows you to shoot with the exposure adjusted automatically (both the shutter speed and the aperture value).

You can set shooting functions such as [ISO].

1 Set the mode dial to P (Program Auto).

2 Set the shooting functions to your desired settings.

3 Adjust the focus and shoot the subject.

Program Shift

When you are not using a flash, you can change the shutter speed and aperture (F-value) combination without changing the appropriate exposure set by the camera.

Turn the front/rear dial to select the aperture value and shutter speed combination.

- "P" on the screen changes to "P*" when you turn the front/rear dial.
- To cancel program shift, set the shooting mode to other than [Program Auto], or turn off the camera.

Note

- According to the brightness of the environment, the program shift may not be used.
- Set the shooting mode to another one than "P" or turn off the power to cancel the setting you made.
- When the brightness changes, the aperture (F-value) and shutter speed also change while maintaining the shift amount.

A Aperture Priority

You can shoot by adjusting the aperture and changing the range in focus, or by defocusing the background.

1 Set the mode dial to A (Aperture Priority).

2 Select the desired value by turning the front/rear dial.

- Smaller F-value: The subject is in focus, but objects in front of and beyond the subject are blurred.
Larger F-value: The subject and its foreground and background are all in focus.
 - If the aperture value you have set is not suitable for appropriate exposure, the shutter speed on the shooting screen will blink. If this happens, change the aperture value.
-

3 Adjust the focus and shoot the subject.

The shutter speed is automatically adjusted to obtain proper exposure.

Note

- The brightness of the image on the screen may differ from the actual image being shot.

S Shutter Priority

You can express the movement of a moving subject in various ways by adjusting the shutter speed, for example, at the instant of the movement with high speed shutter, or as a trailing image with low speed shutter.

1 Set the mode dial to S (Shutter Priority).

2 Select the desired value by turning the front/rear dial.

- If proper exposure cannot be obtained after setup, the aperture value on the shooting screen blinks. If this happens, change the shutter speed.



3 Adjust the focus and shoot the subject.

The aperture is automatically adjusted to obtain proper exposure.

Hint

- Use a tripod to prevent camera-shake when you have selected a slow shutter speed.
- When you shoot indoor sports scenes, set the ISO sensitivity to a higher value.

Note

- The SteadyShot warning indicator does not appear in shutter speed priority mode.
- When [ Long Exposure NR] is set to [On] and the shutter speed is 1 second(s) or longer with a [ Shutter Type] other than [Electronic Shutter] is set, noise reduction after shooting is performed for the same amount of time that the shutter was open. However, you cannot shoot any more while noise reduction is in progress.
- The brightness of the image on the screen may differ from the actual image being shot.

M Manual Exposure

You can shoot with the desired exposure setting by adjusting both the shutter speed and aperture.

1 Set the mode dial to M (Manual Exposure).

2 Select the desired aperture value by turning the front dial.

Select the desired shutter speed by turning the rear dial.

- You can change the setting of the front/rear dial using MENU →  2 (Camera Settings 2) → [Dial Setup].
- You can also set [ISO] to [ISO AUTO] in manual exposure mode. The ISO value automatically changes to achieve the appropriate exposure using the aperture value and shutter speed you have set.
- When [ISO] is set to [ISO AUTO], the ISO value indicator will blink if the value you have set is not suitable for appropriate exposure. If this happens, change the shutter speed or aperture value.
- When [ISO] is set to other than [ISO AUTO], use MM (Metered Manual)* to check the exposure value.

Toward +: Images become brighter.

Toward -: Images become darker.

0: Appropriate exposure analyzed by the product.

* Indicates under/over for appropriate exposure. It is displayed using a numerical value on the monitor and with a metering indicator on the viewfinder.

3 Adjust the focus and shoot the subject.

Hint

- You can change the shutter speed and aperture (F-value) combination without changing the set exposure value by rotating the front/rear dial while pressing the AEL button. (Manual shift)

Note

- The Metered Manual indicator does not appear when [ISO] is set to [ISO AUTO].
- When the amount of ambient light exceeds the metering range of the Metered Manual, the Metered Manual indicator flashes.
- The SteadyShot warning indicator does not appear in manual exposure mode.
- The brightness of the image on the screen may differ from the actual image being shot.

M Bulb shooting

You can shoot a trailing image of the movement of a subject with long exposure.

Bulb shooting is suitable for shooting trails from stars or fireworks, etc.

1 Set the mode dial to M (Manual Exposure).

2 Turn the rear dial clockwise until [BULB] is indicated.

3 Select the aperture value (F-value) using the front dial.

4 Press the shutter button halfway down to focus.

5 Press and hold the shutter button for the duration of the shooting.

As long as the shutter button is pressed, the shutter remains open.

Hint

- When shooting fireworks, etc., focus at infinity in manual focus mode. If you use a lens whose infinity point is unclear, adjust the focus on the fireworks in the area you want to focus on in advance.
- In order to perform bulb shooting without causing the image quality to deteriorate, we recommend that you start shooting while the camera is cool.

- During bulb shooting, images tend to blur. It is recommended that you use a tripod, a RMT-P1BT Bluetooth remote commander (sold separately) or a remote commander equipped with a lock function (sold separately). When using the RMT-P1BT Bluetooth remote commander, you can start bulb shooting by pressing the shutter button on the remote commander. To stop bulb shooting, press the shutter button on the remote commander again. To use the other remote commander, use the model which can be connected via the Multi/Micro USB terminal.

Note



- The longer the exposure time, the more noise will be visible on the image.
- When [ Long Exposure NR] is set to [On], noise reduction is performed after shooting for the same duration that the shutter was open. You cannot shoot while noise reduction is in progress.
- You cannot set the shutter speed to [BULB] in the following situations:

- [Auto HDR]
- [Picture Effect] is set to [Rich-tone Mono.]
- When [Drive Mode] is set to the following:
 - [Cont. Shooting]
 - [Self-timer (Cont)]
 - [Cont. Bracket]
- [ Shutter Type] is set to [Electronic Shutter]

If you use the above functions when the shutter speed is set to [BULB], the shutter speed is temporarily set to 30 seconds.





- If you set [Drive Mode] to [Cont. Shooting] and [ Shutter Type] to [Auto] or [Electronic Shutter] when the shutter speed is set to [BULB], the shutter speed will be temporarily set to 1/8 second.

MR 1/ 2 Recall

Allows you to shoot an image after recalling often-used modes or camera settings registered with [  1/ 2 Memory] in advance (page 176).

1 Set the mode dial to 1, 2, or 3 (Memory recall).



2 Press the center of the control wheel to confirm.



- You can also recall registered modes or settings by selecting MENU →  1 (Camera Settings 1) → [  1/ 2 Recall].

Hint

- To recall settings registered to the memory card, set the mode dial to 1, 2, 3 (Memory recall), then select the desired number by pressing the left/right side of the control wheel.
- If you recall settings registered to the memory card, the settings are recalled from the memory card in the slot specified in [MR Select Media]. You can confirm the memory card slot by selecting MENU →  1 (Camera Settings 1) → [MR Select Media].
- Settings registered to a memory card using another camera of the same model name can be recalled with this camera.

Note

- If you set [MR  1/ 2 Recall] after completing the shooting settings, the registered settings are given priority and the original settings may become invalid. Check the indicators on the screen before shooting.

 Movie:  Exposure Mode

You can set the exposure mode for movie shooting.

1 Set the mode dial to  (Movie).**2 MENU →  2 (Camera Settings 2) → [ Exposure Mode] → desired setting.**

 **P Program Auto:** Allows you to shoot with the exposure adjusted automatically (both the shutter speed and the aperture value).

 **A Aperture Priority:** Allows you to shoot after adjusting the aperture value manually.

 **S Shutter Priority:** Allows you to shoot after adjusting the shutter speed manually.

 **M Manual Exposure:** Allows you to shoot after adjusting the exposure (both the shutter speed and the aperture value) manually.

3 Press the MOVIE (movie) button to start recording.

- Press the MOVIE button again to stop recording.

S&Q S&Q Motion: Exposure Mode

You can select the exposure mode for slow-motion/quick-motion shooting. You can change the setting and playback speed for slow-motion/quick-motion shooting with [ S&Q Settings] (page 152).

1 Set the mode dial to S&Q (S&Q Motion).

2 MENU → 2 (Camera Settings 2) → [Exposure Mode] → desired setting.

 **P Program Auto:** Allows you to shoot with the exposure adjusted automatically (both the shutter speed and the aperture value).

 **A Aperture Priority:** Allows you to shoot after adjusting the aperture value manually.

 **S Shutter Priority:** Allows you to shoot after adjusting the shutter speed manually.

 **M Manual Exposure:** Allows you to shoot after adjusting the exposure (both the shutter speed and the aperture value) manually.

3 Press the MOVIE (movie) button to start recording.

- Press the MOVIE button again to stop recording.
-

Controlling the exposure/metering modes

Exposure Comp.

Normally, exposure is set automatically (auto exposure). Based on the exposure value set by auto exposure, you can make the entire image brighter or darker if you adjust [Exposure Comp.] to the plus side or minus side, respectively (exposure compensation).

Release the exposure compensation dial lock, and turn the exposure compensation dial.

- + **(over) side:** Images become brighter.
- **(under) side:** Images become darker.
- Pressing the lock button at the center switches the exposure compensation dial between the locked and unlocked status. The dial is unlocked when the lock button is popped up and the white line is visible.
- You can adjust the exposure compensation value within the range of -3.0 EV to +3.0 EV.
- You can confirm the exposure compensation value that you set on the shooting screen.

Exposure compensation dial lock button

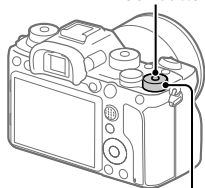

Exposure compensation dial

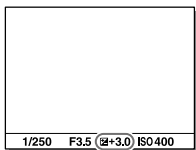

Monitor

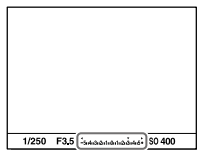

Viewfinder

To set the exposure compensation using the MENU

You can adjust the exposure compensation value within a range of -5.0 EV to +5.0 EV when the exposure compensation dial is set to "0."

MENU →  **1 (Camera Settings 1)** → **[Exposure Comp.]** → **desired setting.**

Hint

- You can operate the exposure compensation dial any time you want while the exposure compensation dial lock is released. The exposure compensation dial lock prevents unintentional changes to exposure compensation values.





Note

- You cannot perform the exposure compensation in the following shooting modes:
 - [Intelligent Auto]
- When using [Manual Exposure], you can perform the exposure compensation only when [ISO] is set to [ISO AUTO].
- The settings of the exposure compensation dial will be prioritized over [Exposure Comp.] or [Dial Ev Comp] in MENU.
- Only a value between -3.0 EV and +3.0 EV with the equivalent image brightness appears on the screen when shooting. If you set an exposure compensation value outside this range, the image brightness on the screen will not be affected, but the value will be reflected in the recorded image.
- You can adjust the exposure compensation value within the range of -2.0 EV to +2.0 EV for movies.
- If you shoot a subject in extremely bright or dark conditions, or when you use the flash, you may not be able to get a satisfactory effect.
- When you set the exposure compensation dial to "0" from a setting other than "0," the exposure compensation value switches to "0" regardless of the [Exposure Comp.] setting.

Metering Mode

Selects the metering mode that sets which part of the screen to measure for determining the exposure.

MENU →  1 (Camera Settings 1) → [Metering Mode] → desired setting.

-  **Multi:** Measures light on each area after dividing the total area into multiple areas and determines the proper exposure of the entire screen (Multi-pattern metering).
-  **Center:** Measures the average brightness of the entire screen, while emphasizing the central area of the screen (Center-weighted metering).
-  **Spot:** Measures only inside the metering circle. This mode is suitable for measuring light on a specified part of the entire screen. The size of the metering circle can be selected from [Spot: Standard] and [Spot: Large]. The position of the metering circle depends the setting for [Spot Metering Point].
-  **Entire Screen Avg.:** Measures the average brightness of the entire screen. The exposure will be stable even if the composition or the position of the subject changes.
-  **Highlight:** Measures the brightness while emphasizing the highlighted area on the screen. This mode is suitable for shooting the subject while avoiding overexposure.

Hint

- When [Spot] is selected and [Focus Area] is set to either [Flexible Spot], [Expand Flexible Spot], [Tracking: Flexible Spot] or [Tracking: Expand Flexible Spot] while [Spot Metering Point] is set to [Focus Point Link], the spot metering point can be coordinated with the focus area.
- When [Multi] is selected and [Face Priority in Multi Metering] is set to [On], the camera measures brightness based on detected faces.
- When [Metering Mode] is set to [Highlight] and the [D-Range Optimizer] or [Auto HDR] function is activated, the brightness and the contrast will be corrected automatically by dividing the image into small areas and analyzing the contrast of light and shadow. Make settings based on the shooting circumstances.

Note

- [Metering Mode] is locked to [Multi] in the following shooting modes:
 - [Intelligent Auto]
 - Other zoom functions than the optical zoom
- In [Highlight] mode, the subject may be dark if a brighter part exists on the screen.

Face Priority in Multi Metering

Sets whether the camera measures brightness based on detected faces when [Metering Mode] is set to [Multi].

MENU →  **1 (Camera Settings 1)** →
[Face Priority in Multi Metering] → **desired setting.**

On: The camera measures brightness based on detected faces.

Off: The camera measures brightness using the [Multi] setting, without detecting faces.

Note

- When the shooting mode is set to [Intelligent Auto], [Face Priority in Multi Metering] is locked to [On].
- When [Face/Eye Priority in AF] is set to [On] and [Subject Detection] is set to [Animal] under [Face/Eye AF Set.], [Face Priority in Multi Metering] does not work.

Spot Metering Point

Sets whether to coordinate the spot metering position with the focus area when [Focus Area] is set to [Flexible Spot], [Expand Flexible Spot], [Tracking: Flexible Spot] or [Tracking: Expand Flexible Spot].

MENU →  1 (Camera Settings 1) → [Spot Metering Point] → **desired setting.**

Center: The spot metering position does not coordinate with the focus area, but always meters brightness at the center.

Focus Point Link: The spot metering position coordinates with the focus area.

Note

- When [Focus Area] is set to other than [Flexible Spot]/[Expand Flexible Spot]/[Tracking: Flexible Spot]/[Tracking: Expand Flexible Spot], the spot metering position is locked to the center.
- When [Focus Area] is set to [Tracking: Flexible Spot] or [Tracking: Expand Flexible Spot], the spot metering position coordinates to the tracking start position, but does not coordinate with the tracking of the subject.

AE lock

When the contrast between the subject and background is high, such as when shooting a backlit subject or a subject near a window, meter the light at a spot where the subject appears to have the appropriate brightness and lock the exposure before shooting. To reduce the brightness of the subject, meter the light at a spot brighter than the subject and lock the exposure of the entire screen. To make the subject brighter, meter the light at a spot darker than the subject and lock the exposure of the entire screen.

1 Adjust the focus on the spot at which the exposure is adjusted.

2 Press the AEL button.

The exposure is locked, and * (AE lock) is displayed.

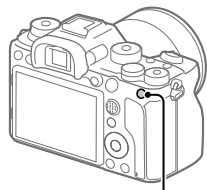

AEL button

3 Keep pressing the AEL button and focus on the subject again, then shoot the picture.

- Keep holding the AEL button down while taking a shot if you want to continue shooting with the fixed exposure. Release the button to reset the exposure.

Hint

- If you select the MENU → 2 (Camera Settings 2) → [Custom Key] or [Custom Key] → [AEL Button] → [AEL toggle], you can lock the exposure without holding down the button.

Note

- [AEL hold] and [AEL toggle] are not available when using zoom functions other than optical zoom.

Correcting brightness and contrast automatically

D-Range Optimizer (DRO)

By dividing the image into small areas, the product analyzes the contrast of light and shadow between the subject and the background, and creates an image with the optimal brightness and gradation.



1 MENU →  1 (Camera Settings 1) → [DRO/Auto HDR] → [D-Range Optimizer].

2 Select the desired setting using the left/right sides of the control wheel.

 **D-Range Optimizer: Auto:** Corrects the brightness automatically.

 **D-Range Optimizer: Lv1 — D-Range Optimizer: Lv5:** Optimizes the gradation of a recorded image for each divided area. Select the optimization level from Lv1 (weak) to Lv5 (strong).

Note

- In the following situations, [DRO/Auto HDR] is fixed to [Off]:
 - When [Picture Effect] is set to other than [Off]
- When  Record Setting] is set to [120p 100M], [100p 100M], [120p 60M], or [100p 60M], or when  Frame Rate] is set to [120fps]/[100fps], [DRO/Auto HDR] switches to [Off].
- When shooting with [D-Range Optimizer], the image may be noisy. Select the proper level by checking the recorded image, especially when you enhance the effect.

Auto HDR

Shoots three images using different exposures and combines the images with correct exposure, the bright parts of an underexposed image, and the dark parts of an overexposed image to create images with a greater range of gradation (High Dynamic Range). One image with proper exposure and one overlaid image are recorded.

1 MENU →  1 (Camera Settings 1) → [DRO/Auto HDR] → [Auto HDR].

2 Select the desired setting using the left/right sides of the control wheel.

 **Auto HDR: Exposure Diff. Auto:** Corrects the brightness automatically.

 **Auto HDR: Exposure Diff. 1.0EV — Auto HDR: Exposure Diff. 6.0EV:** Sets the exposure difference, based on the contrast of the subject. Select the optimization level from 1.0 EV (weak) to 6.0 EV (strong). For example, if you set the exposure value to 2.0 EV, three images will be composed with the following exposure levels: -1.0 EV, correct exposure and +1.0 EV.

Hint

- The shutter is released three times for one shot. Be careful about the following:
 - Use this function when the subject is motionless or does not flash light.
 - Do not change the composition before shooting.

Note

- This function is not available when the [📷 File Format] is [RAW] or [RAW & JPEG].
- [Auto HDR] is not available in the following shooting modes:
 - [Intelligent Auto]
- [Auto HDR] is not available in the following situations:
 - When [Picture Effect] is set to other than [Off].
- You cannot start the next shot until the capture process is completed after you shoot.
- You may not obtain the desired effect depending on the luminance difference of a subject and the shooting conditions.
- When the flash is used, this function has little effect.
- When the contrast of the scene is low or when product shake or subject blur occurs, you may not obtain good HDR images. **HDR** **!** will be displayed over the recorded image to inform you when the camera detects image blurring. Change the composition or re-shoot the image carefully to avoid image blur, as needed.

Selecting the ISO sensitivity

Sensitivity to light is expressed by the ISO number (recommended exposure index). The larger the number, the higher the sensitivity.

ISO (ISO) on the control wheel → select desired setting.

- You can also select MENU →  1 (Camera Settings 1) → [ISO Setting] → [ISO].
- You can change the value by 1/3 EV steps by turning the front dial as well as by turning the control wheel. You can change the value by 1 EV steps by turning the rear dial.



ISO AUTO: Sets the ISO sensitivity automatically.

ISO 50 – ISO 204800: Sets the ISO sensitivity manually. Selecting a larger number increases the ISO sensitivity.

Hint

- You can change the range of ISO sensitivity that is set automatically in [ISO AUTO] mode. Select [ISO AUTO] and press the right side of the control wheel, and set the desired values for [ISO AUTO Maximum] and [ISO AUTO Minimum].

Note

- [ISO AUTO] is selected when using the following functions:
 - [Intelligent Auto]
- When the ISO sensitivity is set to a value lower than ISO 100, the range for recordable subject brightness (dynamic range) may decrease.
- The higher the ISO value, the more noise will appear on the images.
- The available ISO settings will differ depending on whether you are shooting still images, shooting movies, or shooting slow-motion/quick-motion movies.
- ISO values between 50 and 25600 are available in the following situations:
 -  Shutter Type] is set to [Electronic Shutter].
 -  Shutter Type] is set to [Auto] and [Drive Mode] is set to [Cont. Shooting].
- When shooting movies, ISO values between 100 and 102400 are available. If the ISO value is set to a value larger than 102400, the setting is automatically switched to 102400. When you finish recording the movie, the ISO value returns to the original setting.
- When shooting movies, ISO values between 100 and 102400 are available. If the ISO value is set to a value smaller than 100, the setting is automatically switched to 100. When you finish recording the movie, the ISO value returns to the original setting.
- When you select [ISO AUTO] with the shooting mode set to [P], [A], [S] or [M], the ISO sensitivity will be automatically adjusted within the set range.

ISO Range Limit

You can limit the range of ISO sensitivity when the ISO sensitivity is set manually.

MENU → 1 (Camera Settings 1) → [ISO Setting] → [ISO Range Limit] → [Minimum] or [Maximum], and select the desired values.

Note

- ISO sensitivity values beyond the specified range become unavailable. To select ISO sensitivity values beyond the specified range, reset [ISO Range Limit].

To set the range for [ISO AUTO]

If you want to adjust the range of ISO sensitivity that is automatically set in the [ISO AUTO] mode, select **MENU** → 1 (Camera Settings 1) → [ISO Setting] → [ISO] → [ISO AUTO], and then press the right side of the control wheel to select [ISO AUTO Maximum]/[ISO AUTO Minimum].

ISO AUTO Min. SS

If you select [ISO AUTO] when the shooting mode is **P** (Program Auto) or **A** (Aperture Priority), you can set the shutter speed at which the ISO sensitivity starts changing.

This function is effective for shooting moving subjects. You can minimize subject blurring while also preventing camera shake.

MENU → 1 (Camera Settings 1) → [ISO Setting] → [ISO AUTO Min. SS] → desired setting.

FASTER (Faster)/FAST (Fast): The ISO sensitivity will start to change at shutter speeds faster than [Standard], so you can prevent camera shake and subject blurring.

STD (Standard): The camera automatically sets the shutter speed based on the focal length of the lens.

SLOW (Slow)/SLOWER (Slower): The ISO sensitivity will start to change at shutter speeds slower than [Standard], so you can shoot images with less noise.

1/16000 – 30": The ISO sensitivity starts to change at the shutter speed you have set.

Hint

- The difference in shutter speed at which ISO sensitivity starts to change between [Faster], [Fast], [Standard], [Slow], and [Slower] is 1 EV.

Note

- If the exposure is insufficient even when the ISO sensitivity is set to [ISO AUTO Maximum] in [ISO AUTO], in order to shoot with an appropriate exposure, the shutter speed will be slower than the speed set in [ISO AUTO Min. SS].
- In the following situations, the shutter speed may not function as set:
 - When the maximum shutter speed has changed based on the  Shutter Type] setting.
 - When using the flash to shoot bright scenes. (The maximum shutter speed is limited to the flash-syncing speed of 1/250 seconds.)
 - When using the flash to shoot dark scenes with the [Flash Mode] set to [Fill-flash]. (The minimum shutter speed is limited to the speed automatically determined by the camera.)

Using the zoom

The zoom features available with this product

The zoom feature of the product provides a higher magnification zoom by combining various zoom features. The icon displayed on the screen changes, according to the selected zoom feature.

When a power zoom lens is mounted:

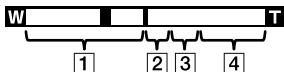

When a lens other than a power zoom lens is mounted:

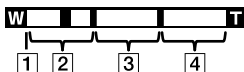

1 Optical zoom range

Zoom images in the zoom range of a lens. When a power zoom lens is mounted, the zoom bar of the optical zoom range is displayed. When a lens other than a power zoom lens is mounted, the zoom slider is fixed at the left end of the zoom bar while the zoom position is in the optical zoom range (displayed as $\times 1.0$).

2 Smart Zoom range (s^Q)

Zoom images without causing the original quality to deteriorate by partially cropping an image (only when [JPEG Image Size] is set to [M] or [S]).

3 Clear Image Zoom range (c^Q)

Zoom images using an image process with less deterioration. When you set [Zoom Setting] to [ClearImage Zoom] or [Digital Zoom], you can use this zoom function.

4 Digital Zoom range (d^Q)

You can magnify images using an image process. When you set [Zoom Setting] to [Digital Zoom], you can use this zoom function.

Note

- The default setting for the [Zoom Setting] is [Optical zoom only].
- The default setting for the [JPEG Image Size] is [L]. To use the smart zoom, change [JPEG Image Size] to [M] or [S].
- The Smart Zoom, Clear Image Zoom and Digital Zoom functions are not available when shooting in the following situations:
 - [File Format] is set to [RAW] or [RAW & JPEG].
 - [Record Setting] is set to [120p]/[100p].
 - During slow-motion/quick-motion shooting with the [Frame Rate] set to [120fps]/[100fps]
 - During continuous shooting with [Shutter Type] set to [Auto] or [Electronic Shutter]
- You cannot use the Smart Zoom function with movies.
- When a power zoom lens is mounted, you cannot use [Zoom] under MENU. If you enlarge image past the optical zoom range, the product automatically switches to another [Zoom] function than the optical zoom.
- When you use a zoom function other than the optical zoom, the [Focus Area] setting is disabled and the focusing frame is shown by the dotted line. The AF operates with priority on and around the center area.
- When you use the Smart Zoom, Clear Image Zoom or Digital Zoom function, [Metering Mode] is locked to [Multi].
- When using the Smart Zoom, Clear Image Zoom or Digital Zoom function, the following functions are not available:
 - Face/Eye Priority in AF
 - Face Priority in Multi Metering
 - Tracking function
- To use another zoom function than the optical zoom for movies, assign [Zoom] to the desired key using [Custom Key] (page 179).

Clear Image Zoom/Digital Zoom (Zoom)

When you use a zoom function other than the optical zoom, you can exceed the zoom range of the optical zoom.



1 MENU → 2 (Camera Settings 2) → [Zoom Setting] → [ClearImage Zoom] or [Digital Zoom].

2 When a power zoom lens is mounted, move the zoom lever or the zoom ring of the zoom lens to enlarge subjects.

- When you exceed the zoom range of the optical zoom, the camera automatically switches to another zoom than the optical zoom.

3 When a lens other than a power zoom lens is mounted, select MENU → 2 (Camera Settings 2) → [Zoom] → desired value.

Press the center of the control wheel to exit.

- You can also assign the [Zoom] function to the desired button by selecting MENU →  2 (Camera Settings 2) → [ Custom Key] or [ Custom Key].

About zoom scale

The zoom scale that is used in combination with the zoom of the lens changes according to the selected image size.

When [Aspect Ratio] is [3:2]

Zoom Setting	 JPEG Image Size	Full-frame/APS-C	Zoom scale
Optical zoom only (including smart zoom)	L	—	—
	M	Full-frame	Approx. 1.5×
		APS-C	Approx. 1.3×
	S	Full-frame	Approx. 2×
		APS-C	Approx. 2×
	ClearImage Zoom	L	Full-frame
APS-C			Approx. 2×
M		Full-frame	Approx. 3×
		APS-C	Approx. 2.6×
S		Full-frame	Approx. 4×
		APS-C	Approx. 4×
Digital Zoom	L	Full-frame	Approx. 4×
		APS-C	Approx. 4×
	M	Full-frame	Approx. 6.1×
		APS-C	Approx. 5.2×
	S	Full-frame	Approx. 8×
		APS-C	Approx. 8×

White Balance

Corrects the tone effect of the ambient light condition to record a neutral white subject in white. Use this function when the color tones of the image did not come out as you expected, or when you want to change the color tones on purpose for photographic expression.

MENU → 1 (Camera Settings 1) → [White Balance] → desired setting.

AWB AWB Auto / Daylight / Shade / Cloudy /

Incandescent / -1 Fluor.: Warm White / 0 Fluor.: Cool White /
 +1 Fluor.: Day White / +2 Fluor.: Daylight / Flash /

Underwater Auto: When you select a light source that illuminates the subject, the product adjusts the color tones to suit to the selected light source (preset white balance). When you select [Auto], the product automatically detects the light source and adjusts the color tones.

C.Temp./Filter: Adjusts the color tones depending on the light source. Achieves the effect of CC (Color Compensation) filters for photography.

Custom 1/Custom 2/Custom 3: Memorizes the basic white color under the light conditions for the shooting environment.

Hint

- You can display the fine adjustment screen and perform fine adjustments of the color tones as required by pressing the right side of the control wheel. When [C.Temp./Filter] is selected, you can change the color temperature by turning the rear dial instead of pressing the right side of the control wheel.
- If the color tones do not come out as you expected in the selected settings, perform [WB bracket] shooting.
- or is displayed only when [Priority Set in AWB] is set to [Ambience] or [White].

Note

- [White Balance] is fixed to [Auto] in the following shooting modes:
 - [Intelligent Auto]
- If you use a mercury lamp or a sodium lamp as a light source, the accurate white balance will not be obtained because of the characteristics of the light. It is recommended to shoot images using a flash or select [Custom 1] to [Custom 3].

Capturing a standard white color to set the white balance (custom white balance)

In a scene where the ambient light consists of multiple types of light sources, it is recommended to use the custom white balance in order to accurately reproduce the whiteness. You can register 3 settings.

1 MENU → 1 (Camera Settings 1) → [White Balance] → Select from among [Custom 1] to [Custom 3], and then press the right side of the control wheel.

2 Select  SET, and then press the center of the control wheel.

3 Hold the product so that the white area fully covers the white-balance capture frame, and then press the center of the control wheel.

After the shutter sound beeps, the calibrated values (Color Temperature and Color Filter) are displayed.

- You can adjust the position of the white-balance capture frame by pressing the top/bottom/left/right side of the control wheel.
- After capturing a standard white color, you can display the fine adjustment screen by pressing the right side of the control wheel. You can finely adjust the color tones as needed.

4 Press the center of the control wheel.

The calibrated values will be registered. The monitor returns to the MENU display while retaining the memorized custom white balance setting.

- The registered custom white balance setting will remain memorized until overwritten by another setting.



Note

- The message [Capturing of the custom WB failed.] indicates that the value is in the unexpected range, for example when the subject is too vivid. You can register the setting at this point, but it is recommended that you set the white balance again. When an error value is set, the indicator  turns orange on the recording information display. The indicator will be displayed in white when the set value is in the expected range.
- If you use a flash when capturing a basic white color, the custom white balance will be registered with the lighting from the flash. Be sure to use a flash whenever you shoot with recalled settings that were registered with a flash.

Shutter AWB Lock

You can set whether or not to lock the white balance while the shutter button is pressed when [White Balance] is set to [Auto] or [Underwater Auto].

This function prevents unintentional changes to the white balance during continuous shooting or when shooting with the shutter button pressed halfway down.



MENU →  1 (Camera Settings 1) → [ Shutter AWB Lock] → **desired setting.**

Shut. Halfway Down: Locks the white balance while the shutter button is pressed halfway down, even in the auto white balance mode. The white balance is also locked during continuous shooting.

Cont. Shooting: Locks the white balance to the setting in the first shot during continuous shooting, even in the auto white balance mode.

Off: Operates with the normal auto white balance.



About [AWB Lock Hold] and [AWB Lock Toggle]

You can also lock the white balance in the auto white balance mode by assigning [AWB Lock Hold] or [AWB Lock Toggle] to the custom key. Select MENU → 2 (Camera Settings 2) → Assign [AWB Lock Hold] or [AWB Lock Toggle] using [ Custom Key]. If you press the assigned key during shooting, the white balance will be locked.

The [AWB Lock Hold] function locks the white balance by stopping the automatic white balance adjustment while the button is pressed.

The [AWB Lock Toggle] function locks the white balance by stopping the automatic white balance adjustment after the button is pressed once.

When you press the button again, the AWB lock is released.

- If you want to lock the white balance during movie shooting in the auto white balance mode, select MENU → 2 (Camera Settings 2) → Assign [AWB Lock Hold] or [AWB Lock Toggle] using [ Custom Key].

Hint

- When you shoot with the flash while the automatic white balance is locked, the resulting color tones may be unnatural because the white balance was locked before the flash was emitted. In this case, set [ Shutter AWB Lock] to [Off] or [Cont. Shooting], and do not use the [AWB Lock Hold] function or [AWB Lock Toggle] function when shooting. Alternatively, set [White Balance] to [Flash].

Setting how to process images

Creative Style

Allows you to set the desired image processing and finely adjust contrast, saturation and sharpness for each image style.

1 MENU → 1 (Camera Settings 1) → [Creative Style].

2 Select the desired style or [Style Box] using the top/bottom sides of the control wheel.

Std. **Standard:** For shooting various scenes with rich gradation and beautiful colors.

Vivid **Vivid:** The saturation and contrast are heightened for shooting striking images of colorful scenes and subjects such as flowers, spring greenery, blue sky, or ocean views.

Ntri **Neutral:** The saturation and sharpness are lowered for shooting images in subdued tones. This is also suitable for capturing image material to be modified with a computer.

Clear **Clear:** For shooting images in clear tones with limpid colors in highlight, suitable for capturing radiant light.

Deep **Deep:** For shooting images with deep and dense colors, suitable for capturing the solid presence of the subject.

Light **Light:** For shooting images with bright and simple colors, suitable for capturing a refreshingly light ambience.

Port. **Portrait:** For capturing skin in a soft tone, ideally suited for shooting portraits.

Land. **Landscape:** The saturation, contrast, and sharpness are heightened for shooting vivid and crisp scenery. Distant landscapes also stand out more.

Sunset **Sunset:** For shooting the beautiful red of the setting sun.

Night **Night Scene:** The contrast is lowered for reproducing night scenes.

Autm **Autumn leaves:** For shooting autumn scenes, vividly highlighting the reds and yellows of changing leaves.

B/W **Black & White:** For shooting images in black and white monotone.

Sepia **Sepia:** For shooting images in sepia monotone.

Std **Registering preferred settings (Style Box):** Select the six style box (the boxes with numbers on the left side (**Std**)) to register preferred settings. Then select the desired settings using the right button.

You can call up the same style with slightly different settings.

- 3 To adjust (Contrast), (Saturation) and (Sharpness), select the desired item using the right/left sides, and then select the value using the top/bottom sides.**

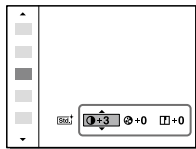

- 4 When selecting [Style Box], move to the right side using the right side of the control wheel, and then select the desired style.**

- You can call up the same style with slightly different settings.

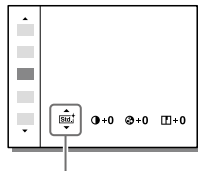

Displayed only when Style Box is selected

■ To set [Contrast], [Saturation] and [Sharpness]

[Contrast], [Saturation] and [Sharpness] can be adjusted for each image style preset such as [Standard] and [Landscape], and for each [Style Box] to which you can register preferred settings.

Select an item to be set by pressing the right/left sides of the control wheel, then set the value using the top/bottom sides of the control wheel.



- **Contrast:** The higher the value selected, the more the difference of light and shadow is accentuated, and the bigger the effect on the image.
- **Saturation:** The higher the value selected, the more vivid the color. When a lower value is selected, the color of the image is restrained and subdued.
- ▣ **Sharpness:** Adjusts the sharpness. The higher the value selected, the more the contours are accentuated, and the lower the value selected, the more the contours are softened.

Note

- [Creative Style] is fixed to [Standard] in the following situations:
 - [Intelligent Auto]
 - [Picture Effect] is set to other than [Off].
- When this function is set to [Black & White] or [Sepia], [Saturation] cannot be adjusted.

Color Space

The way colors are represented using combinations of numbers or the range of color reproduction is called “color space.” You can change the color space depending on the purpose of the image.

MENU →  1 (Camera Settings 1) → [ Color Space] → **desired setting.**

sRGB: This is the standard color space of the digital camera. Use [sRGB] in normal shooting, such as when you intend to print out the images without any modification.

AdobeRGB: This color space has a wide range of color reproduction. When a large part of the subject is vivid green or red, Adobe RGB is effective. The file name of the recorded image starts with “_.”

Note

- [AdobeRGB] is for applications or printers that support color management and DCF2.0 option color space. Images may not be printed or viewed in the correct colors if you use applications or printers that do not support Adobe RGB.
- When displaying images that were recorded with [AdobeRGB] on non-Adobe RGB-compliant devices, the images will be displayed with low saturation.

Reducing blur

Sets whether or not to use the SteadyShot function.

MENU →  **2 (Camera Settings 2)** → **[SteadyShot]** → **desired setting.**

On: Uses [SteadyShot].

Off: Does not use [SteadyShot]. We recommend that you set [Off] when using a tripod, etc.

SteadyShot Settings

You can shoot with an appropriate SteadyShot setting for the attached lens.

1 MENU →  **2 (Camera Settings 2)** → **[SteadyShot]** → **[On].**

2 [SteadyShot Settings] → **[SteadyShot Adjust.]** → **desired setting.**



Auto: Performs the SteadyShot function automatically according to the information obtained from the attached lens.

Manual: Performs the SteadyShot function according to the focal-length set using [SteadyS. Focal Len.]. (8mm – 1000mm)

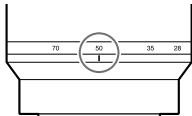
- Check the focal-length index and set the focal-length.





Note

- The SteadyShot function may not work optimally when the power has just been turned on, right after you point the camera towards a subject, or when the shutter button has been pressed all the way down without stopping halfway.
- When using a tripod, etc., make sure to turn off the SteadyShot function because this can cause any malfunction when shooting.
- [SteadyShot Settings] will be unavailable when MENU →  2 (Camera Settings 2) → [SteadyShot] is set to [Off].
- When the camera cannot obtain focal length information from the lens, the SteadyShot function does not work correctly. Set [SteadyShot Adjust.] to [Manual] and set [SteadyS. Focal Len.] to match the lens you are using. The current set value of the SteadyShot focal length will display to the side of ().
- When using an SEL16F28 lens (sold separately) with a teleconverter, etc., set [SteadyShot Adjust.] to [Manual] and set the focal length.
- When you set [SteadyShot] to [On]/[Off], the SteadyShot settings of the camera and lens switch at the same time.
- If a lens equipped with a SteadyShot switch is attached, the settings can only be changed using that switch on the lens. You cannot switch the settings using the camera.

Noise reduction

Long Exposure NR





When you set the shutter speed to 1 second(s) or longer (long exposure shooting), noise reduction is turned on for the duration that the shutter is open. With the function turned on, the grainy noise typical of long exposures is reduced.

MENU → 1 (Camera Settings 1) →  Long Exposure NR → **desired setting.**

On: Activates noise reduction for the same duration that the shutter is open. When noise reduction is in progress, a message appears and you cannot take another picture. Select this to prioritize the image quality.



Off: Does not activate noise reduction. Select this to prioritize the timing of shooting.

Note

-  Long Exposure NR is not available when  Shutter Type] is set to [Electronic Shutter].
- Noise reduction may not be activated even if  Long Exposure NR] is set to [On] in the following situations:
 - [Drive Mode] is set to [Cont. Shooting] or [Cont. Bracket].
-  Long Exposure NR] cannot be set to [Off] in the following shooting modes:
 - [Intelligent Auto]

High ISO NR

When shooting with high ISO sensitivity, the product reduces noise that becomes more noticeable when the product sensitivity is high.





MENU →  1 (Camera Settings 1) →  High ISO NR → desired setting.

Normal: Activates high ISO noise reduction normally.

Low: Activates high ISO noise reduction moderately.

Off: Does not activate high ISO noise reduction. Select this to prioritize the timing of shooting.

Note

-  High ISO NR] is fixed to [Normal] in the following shooting modes:
 - [Intelligent Auto]
- When  File Format] is set to [RAW], this function is not available.
-  High ISO NR] does not work for RAW images when the  File Format] is [RAW & JPEG].

Using flash (sold separately)

In dark environments, use the flash to light up the subject while shooting. Also use the flash to prevent camera-shake. For details on the flash, refer to the instruction manual for the flash.

1 Attach the flash (sold separately) to the product.



2 Shoot after you have turned on the flash and it is fully charged.

- ⚡ blinking: Charging is in progress
- ⚡ lit up: Charging is finished
- The available flash modes depend on the shooting mode and function.

Note

- A flash cannot be used when [📷 Shutter Type] is set to [Electronic Shutter].
- A flash can be used during continuous shooting with [📷 Shutter Type] set to [Auto]. The mechanical shutter will be used.
- The light of the flash may be blocked if the lens hood is attached and the lower part of a recorded image may be shaded. Remove the lens hood.
- When using the flash, stand 1 m or more away from the subject.
- You cannot use the flash when recording movies. (You can use an LED light when using a flash (sold separately) with an LED light.)
- Before attaching/removing an accessory such as a flash to/from the Multi Interface Shoe, turn off the product first. When attaching an accessory, make sure that the accessory is fixed securely to the product.

- Do not use the Multi Interface Shoe with a commercially available flash that applies voltage of 250 V or more or has the reverse polarity of the camera. Doing so may cause a malfunction.
- You can use a flash of the reverse polarity with the Sync Terminal. Please use a flash with a sync voltage of 400 V or less.
- When shooting with the flash and the zoom is set to W, the shadow of the lens may appear on the screen, depending on the shooting conditions. If this happens, shoot away from the subject or set the zoom to T and shoot with the flash again.
- The corners of a recorded image may be shaded, depending on the lens.
- When shooting with an external flash, light and dark stripes may appear on the image if the shutter speed is set to faster than 1/4000 seconds. If this occurs, Sony recommends shooting in the manual flash mode and setting the flash level to 1/2 or higher.
- For details on compatible accessories for the Multi Interface Shoe, visit the Sony website, or consult your Sony dealer or local authorized Sony service facility.

Flash Mode

You can set the flash mode.

MENU →  1 (Camera Settings 1) → [Flash Mode] → desired setting.

 **Flash Off:** The flash does not operate.

 **Autoflash:** The flash works in dark environments or when shooting towards bright light.

 **Fill-flash:** The flash works every time you trigger the shutter.

 **Slow Sync.:** The flash works every time you trigger the shutter. Slow sync shooting allows you to shoot a clear image of both the subject and the background by slowing the shutter speed.

 **Rear Sync.:** The flash works right before the exposure is completed every time you trigger the shutter. Rear sync shooting allows you to shoot a natural image of the trail of a moving subject such as a moving car or a walking person.

Note

- The default setting depends on the shooting mode.
- Some [Flash Mode] settings are not available, depending on the shooting mode.

Flash Comp.

Adjusts the amount of flash light in a range of -3.0 EV to +3.0 EV. Flash compensation changes the amount of flash light only. Exposure compensation changes the amount of flash light along with the change of the shutter speed and aperture.

MENU →  **1 (Camera Settings 1)** → **[Flash Comp.]** → **desired setting.**

- Selecting higher values (+ side) makes the flash level higher, and lower values (- side) makes the flash level lower.
-

Note

- [Flash Comp.] does not work when the shooting mode is set to the following modes:
 - [Intelligent Auto]
- The higher flash effect (+ side) may not be visible due to the limited amount of flash light available, if the subject is outside the maximum range of the flash. If the subject is very close, the lower flash effect (- side) may not be visible.
- If you attach an ND filter to the lens or attach a diffuser or a color filter to the flash, the appropriate exposure may not be achieved and images may turn out dark. In this case, adjust [Flash Comp.] to the desired value.

FEL lock

The flash level is automatically adjusted so that the subject gets the optimum exposure during normal flash shooting. You can also set the flash level in advance.

FEL: Flash Exposure Level

1 MENU → **2 (Camera Settings 2)** → [**Custom Key**] → **desired button, then assign the [FEL Lock toggle] function to the button.**

2 Center the subject on which FEL is to be locked, and adjust the focus.



3 Press the button to which [FEL Lock toggle] is registered, and set the flash amount.

- A pre-flash flashes.
- The **FL** (FEL lock) lights up.

4 Adjust the composition and shoot the image.

- When you want to release the FEL lock, press the button to which the [FEL Lock toggle] is registered again.

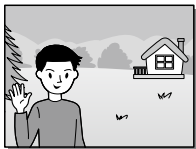

Hint

- By setting [FEL Lock hold], you can hold the setting while the button is pressed down. Also, by setting [FEL Lock/AEL hold] and [FEL Lock/AEL toggle], you can shoot images with the AE locked in the following situations.
 - When [Flash Mode] is set to [Flash Off] or [Autoflash].
 - When the flash cannot go off.
 - When using an external flash that is set to manual flash mode.

Note

- The FEL lock cannot be set when a flash is not attached.
- If a flash that does not support the FEL lock is attached, an error message is displayed.
- When both AE and FEL lock are fixed,  lights up.

Wireless Flash

There are two methods for wireless flash shooting: light-signal flash shooting that uses the light of the flash attached to the camera as a signal light, and radio-signal flash shooting that uses wireless communication. To perform radio-signal flash shooting, use a compatible flash or the Wireless Radio Commander (sold separately).

For details on how to set each method, refer to the instruction manual of the flash or the Wireless Radio Commander.

1 MENU → 1 (Camera Settings 1) → [Wireless Flash] → [On].

Off: Does not use the wireless flash function.

On: Uses the wireless flash function to make an external flash or flashes emit light at a distance from the camera.

2 Remove the shoe cap from the camera, and then attach the flash or the Wireless Radio Commander.

- When performing light-signal wireless flash shooting, set the attached flash as the controller.
When performing radio-signal wireless flash shooting with a flash attached to the camera, set the attached flash as the commander.

3 Set up an off-camera flash that is set to wireless mode, or that is attached to the Wireless Radio Receiver (sold separately).

- You can perform a test flashing by assigning the [Wireless Test Flash] function to a custom key using  Custom Key], and then pressing that key.

Note

- The off-camera flash may emit light after receiving a light signal from a flash used as the controller of another camera. If this occurs, change the channel of your flash. For details on how to change the channel, refer to the instruction manual for the flash.
- For the flash that is compatible with wireless flash shooting, visit the Sony website, or consult your Sony dealer or local authorized Sony service facility.

Using a flash with a sync terminal cord

Open the cover of ⚡ (flash sync) terminal, and connect the cord.

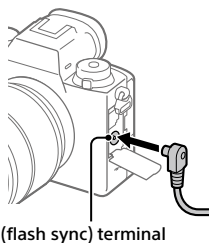

Hint

- If the screen is too dark to check the composition, set [Live View Display] to [Setting Effect OFF] to make it easy to check the composition when shooting with a flash.
- Flashes that have a sync terminal with reversed polarity can be used with this product.

Note

- Set the exposure mode to manual exposure (other than ISO AUTO is recommended for ISO sensitivity), and set the shutter speed to the slower of the following values or slower:
 - 1/200 seconds
 - The shutter speed recommended by the flash.
- Use flashes with a sync voltage of 400 V or lower.
- Turn off the flash connected to the sync cord when you connect the sync cord to the ⚡ (flash sync) terminal. Otherwise, the flash may emit light when the sync cord is connected.
- The flash power level is set to full power. [Flash Comp.] cannot be set.
- Auto white balance function is not recommended. Use the custom white balance function to achieve a more accurate white balance (page 127).
- When a flash is connected to the ⚡ (flash sync) terminal, the flash indicator will not be displayed.
- Flash cannot be used when [ Shutter Type] is set to [Electronic Shutter].

Shooting movies

You can record movies by pressing the MOVIE (Movie) button.

1 Press the MOVIE button to start recording.

- Since the [MOVIE Button] is set to [Always] in the default setting, movie recording can be started from any shooting mode.

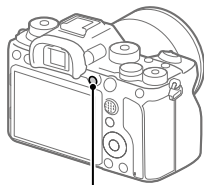

MOVIE button



2 Press the MOVIE button again to stop recording.

Hint

- You can assign the start/stop movie recording function to a preferred key.
MENU → 2 (Camera Settings 2) → Custom Key → set [MOVIE] to the preferred key.
- When you want to specify the area to be focused on, set the area using [Focus Area].
- To keep the focus on a face, arrange the composition so that the focusing frame and face detection frame overlap, or set the [Focus Area] to [Wide].
- You can focus quickly while shooting movies by pressing the shutter button halfway down. (The sound of auto focus operation may be recorded in some cases.)
- To adjust the shutter speed and aperture value to the desired settings, set the shooting mode to (Movie) and select the desired exposure mode.
- An icon indicating that data is being written is displayed after shooting. Do not remove the memory card while the icon is displayed.

- The following settings for still image shooting are applied to the movie shooting:
 - White Balance
 - Creative Style
 - Metering Mode
 - Face/Eye Priority in AF
 - Face Priority in Multi Metering
 - D-Range Optimizer
 - Lens Comp.
- You can change the settings for ISO sensitivity, exposure compensation, and focus area while shooting movies.
- While shooting movies, the recorded image can be output without the shooting information display by setting [HDMI Info. Display] to [Off].

Note

- The sound of the lens and the product in operation may be recorded during movie recording. You can turn the sound off by selecting MENU →  2 (Camera Settings 2) → [Audio Recording] → [Off].
- When shooting, the sound of the shoulder strap hooks (triangular hook) could be recorded, depending on the situation used.
- To prevent the operating sound of the zoom ring from being recorded during movie recording when a power zoom lens is used, we recommend recording movies using the zoom lever. When you move the zoom lever, place your finger lightly on the lever and operate it without flicking.
- The temperature of the camera tends to rise when shooting movies continuously, and you may feel that the camera is warm. This is not a malfunction.
Also, [Internal temp. high. Allow it to cool.] may appear. In such cases, turn the power off and cool the camera and wait until the camera is ready to shoot again.
- If the  icon appears, the temperature of the camera has risen. Turn the power off and cool the camera and wait until the camera is ready to shoot again.
- For the continuous shooting time of a movie recording, refer to “Recordable movie times” (page 250). When movie recording is finished, you can record another movie by pressing the MOVIE button again. Recording may stop to protect the product, depending on the temperature of the product or the battery.
- When the mode dial is set to  (Movie) or **S&Q** or when shooting movies, you cannot select [Tracking] for [Focus Area].

- In [Program Auto] mode when shooting movies, the aperture value and the shutter speed will be set automatically and cannot be changed. For that reason, the shutter speed may become fast in a bright environment, and the motion of the subject may not be recorded smoothly. By changing the exposure mode and adjusting the aperture value and the shutter speed, the motion of the subject can be recorded smoothly.
- When shooting movies, ISO values between ISO 100 and ISO 102400 are available. If the ISO value is set to a value larger than ISO 102400, the setting is automatically switched to ISO 102400. When you finish recording the movie, the ISO value returns to the original setting.
- In movie shooting mode, ISO sensitivity can be selected from ISO 100 to ISO 102400. If the ISO value is set to a value smaller than ISO 100, the setting is automatically switched to ISO 100. When you finish recording the movie, the ISO value returns to the original setting.
- In movie shooting mode, the following settings cannot be set in [Picture Effect]. When a movie recording starts, [Off] will be set temporarily.
 - Rich-tone Mono.
- The Face Detection function/Eye Detection function is not available in the following situations.
 - [File Format] is set to [XAVC S 4K], [Record Setting] is set to [30p 100M]/[25p 100M] or [30p 60M]/[25p 60M], and [4K Output Select] is set to [Memory Card+HDMI]
- If you point the camera at an extremely strong light source while shooting a movie at low ISO sensitivity, the highlighted area in the image may be recorded as a black area.
- If the display mode of the monitor is set to [For viewfinder], the display mode will switch to [Display All Info.] when movie shooting starts.
- Use PlayMemories Home when importing XAVC S movies and AVCHD movies to a computer.

■ Movie w/ shutter

You can start or stop recording movies by pressing the shutter button, which is bigger and easier to press than the MOVIE (Movie) button.

MENU →  2 (Camera Settings 2) → **[Movie w/ shutter]** → **desired setting.**

On: Enables movie recording using the shutter button when the shooting mode is set to [Movie] or [S&Q Motion].

Off: Disables movie recording using the shutter button.

Hint

- When [Movie w/ shutter] is set to [On], you can still start or stop recording movies using the MOVIE button.
- When [Movie w/ shutter] is set to [On], you can use the shutter button to start or stop recording movies on an external recording/playback device using  REC Control] (page 198).

Note

- When [Movie w/ shutter] is set to [On], you cannot focus by pressing the shutter button halfway down during movie recording.

Changing settings for movie recording

File Format

Selects the movie file format.

MENU →  2 (Camera Settings 2) → [File Format] → desired setting.

File Format	Characteristics	
XAVC S 4K	Records movies in 4K resolution (3840×2160).	You can save movies on a computer using the PlayMemories Home software.
XAVC S HD	Records movies in crisper quality than AVCHD with larger amounts of data.	
AVCHD	The AVCHD format has a high degree of compatibility with storage devices other than computers.	You can save movies on a computer or create a disc that supports this format using the PlayMemories Home software.

For details on memory cards that can be used for these formats, refer to page 248.

Note

- When [File Format] is set to [AVCHD], the file size of movies is limited to approx. 2 GB. If the movie file size reaches approx. 2 GB during recording, a new movie file will be created automatically.

Record Setting

Selects the frame rate and bit-rate for movie recording.

MENU → **2 (Camera Settings 2)** → **Record Setting** → **desired setting.**

- The higher the bit-rate, the higher the image quality.
- For estimates of the maximum recordable movie time with each recording setting, refer to page 250.

When **File Format** is set to **[XAVC S 4K]**

Record Setting	Bit-rate	Description
30p 100M/25p 100M	Approx. 100 Mbps	Records movies in 3840×2160 (30p/25p).
30p 60M/25p 60M	Approx. 60 Mbps	Records movies in 3840×2160 (30p/25p).
24p 100M*	Approx. 100 Mbps	Records movies in 3840×2160 (24p).
24p 60M*	Approx. 60 Mbps	Records movies in 3840×2160 (24p).

* Only when [NTSC/PAL Selector] is set to NTSC

When [File Format] is set to [XAVC S HD]

Record Setting	Bit-rate	Description
60p 50M/50p 50M	Approx. 50 Mbps	Records movies in 1920×1080 (60p/50p).
60p 25M/50p 25M	Approx. 25 Mbps	Records movies in 1920×1080 (60p/50p).
30p 50M/25p 50M	Approx. 50 Mbps	Records movies in 1920×1080 (30p/25p).
30p 16M/25p 16M	Approx. 16 Mbps	Records movies in 1920×1080 (30p/25p).
24p 50M*	Approx. 50 Mbps	Records movies in 1920×1080 (24p).
120p 100M/100p 100M	Approx. 100 Mbps	Records high-speed movies in 1920×1080 (120p/100p). You can record movies in 120 fps or 100 fps. <ul style="list-style-type: none"> You can create smoother slow-motion movies by using compatible editing devices.
120p 60M/100p 60M	Approx. 60 Mbps	Records high-speed movies in 1920×1080 (120p/100p). You can record movies in 120 fps or 100 fps. <ul style="list-style-type: none"> You can create smoother slow-motion movies by using compatible editing devices.

* Only when [NTSC/PAL Selector] is set to NTSC

When [File Format] is set to [AVCHD]

Record Setting	Bit-rate	Description
60i 24M (FX)/ 50i 24M (FX)	24 Mbps at maximum	Records movies in 1920×1080 (60i/50i).
60i 17M (FH)/ 50i 17M (FH)	Approx. 17 Mbps on average	Records movies in 1920×1080 (60i/50i).

Note

- Creating an AVCHD recording disc from movies that were recorded with [60i 24M (FX)]/[50i 24M (FX)] as the [Record Setting] takes a long time because the image quality of movies is converted. If you want to store movies without converting them, use a Blu-ray Disc.
- [120p]/[100p] cannot be selected for the following settings.
 - [Intelligent Auto]
- In full-frame shooting, the angle of view will be narrower under the following conditions:
 - When [File Format] is set to [XAVC S 4K] and [Record Setting] is set to [30p]

S&Q S&Q Settings

You can record a moment that cannot be captured by the naked eye (slow-motion recording), or record a long-term phenomenon into a compressed movie (quick-motion recording). For example, you can record an intense sports scene, the moment when a bird starts to fly, a blooming flower, and a changing view of clouds or a starry sky. Sound will not be recorded.

1 Set the mode dial to S&Q (S&Q Motion).

2 Select MENU → 2 (Camera Settings 2) → [S&Q Exposure Mode] → and select the desired setting of slow-motion/quick-motion ([S&Q Program Auto], [S&Q Aperture Priority], [S&Q Shutter Priority], or [S&Q Manual Exposure]).

3 Select MENU → 2 (Camera Settings 2) → [S&Q S&Q Settings] and select the desired settings for [S&Q Record Setting] and [S&Q Frame Rate].

S&Q Record Setting: Selects the frame rate of the movie.

S&Q Frame Rate: Selects the shooting frame rate.

4 Press the MOVIE (movie) button to start recording.

- Press the MOVIE button again to stop recording.

Playback speed

The playback speed will vary as below depending on the assigned [S&Q Record Setting] and [S&Q Frame Rate].

When [NTSC/PAL Selector] is set to NTSC

S&Q Frame Rate	S&Q Record Setting		
	24p	30p	60p
120fps	5 times slower	4 times slower	—
60fps	2.5 times slower	2 times slower	Normal playback speed
30fps	1.25 times slower	Normal playback speed	2 times quick
15fps	1.6 times quick	2 times quick	4 times quick
8fps	3 times quick	3.75 times quick	7.5 times quick
4fps	6 times quick	7.5 times quick	15 times quick
2fps	12 times quick	15 times quick	30 times quick
1fps	24 times quick	30 times quick	60 times quick

When [NTSC/PAL Selector] is set to PAL

S&Q Frame Rate	S&Q Record Setting	
	25p	50p
100fps	4 times slower	—
50fps	2 times slower	Normal playback speed
25fps	Normal playback speed	2 times quick
12fps	2.08 times quick	4.16 times quick
6fps	4.16 times quick	8.3 times quick
3fps	8.3 times quick	16.6 times quick
2fps	12.5 times quick	25 times quick
1fps	25 times quick	50 times quick

- When [S&Q Frame Rate] is set to [120fps]/[100fps], you cannot set [S&Q Record Setting] to [60p]/[50p].

Note

- In slow-motion recording, the shutter speed becomes faster and you may not be able to obtain the proper exposure. If this happens, decrease the aperture value or adjust the ISO sensitivity to a higher value.
- For an estimation of recordable time, refer to “Recordable movie times” (page 250).
- The bit-rate of a recorded movie varies depending on the settings for [S&Q Frame Rate] and [S&Q Record Setting].
- The movie will be recorded in XAVC S HD format.
- During slow-motion/quick-motion recording, the following functions are not available.
 - [TC Run] under [TC/UB Settings]
 - [TC Output] under [HDMI Settings]
 - [4K Output Select]

Audio Recording

Sets whether to record sounds when shooting movies. Select [Off] to avoid recording the sounds of the lens and the camera operating.

MENU →  2 (Camera Settings 2) → [Audio Recording] → **desired setting.**

On: Records sound (stereo).

Off: Does not record sound.

Audio Rec Level

You can adjust the audio recording level while checking the level meter.

1 MENU →  **2 (Camera Settings 2)** → **[Audio Rec Level]**.

2 Select the desired level using the right/left sides of the control wheel.

+: Turns up the audio recording level.

-: Turns down the audio recording level.

Reset: Resets the audio recording level to the default setting.

Hint

- When you record audio movies with loud volumes, set [Audio Rec Level] to a lower sound level. Doing so enables you to record more realistic audio.
- When you record audio movies with lower volumes, set [Audio Rec Level] to a greater sound level to make the sound easier to hear.

Note

- Regardless of the [Audio Rec Level] settings, the limiter always operates.
- [Audio Rec Level] is available only when the shooting mode is set to movie mode.
- [Audio Rec Level] is unavailable during slow-motion/quick-motion shooting.
- The [Audio Rec Level] settings are applied for both the internal microphone and the  (microphone) terminal input.
- The setting for [Audio Rec Level] does not apply to recordings made using [Voice Memo].

Marker Settings

Marker Display

Sets whether or not to display markers set using [ Marker Settings] on the monitor or the viewfinder while shooting movies.

MENU →  2 (Camera Settings 2) → [ Marker Display] → **desired setting.**

On: Markers are displayed. The markers are not recorded.



Off: No marker is displayed.

Note

- The markers are displayed when the mode dial is set to  (Movie) or S&Q, or when shooting movies.
- You cannot display markers when using [Focus Magnifier].
- The markers are displayed on the monitor or viewfinder. (You cannot output the markers.)

Marker Settings

Sets the markers to be displayed while shooting movies.

MENU →  2 (Camera Settings 2) → [ Marker Settings] → **desired setting.**

Center: Sets whether or not to display the center marker in the center of the shooting screen.
[Off] / [On]

Aspect: Sets the aspect marker display.
[Off] / [4:3] / [13:9] / [14:9] / [15:9] / [1.66:1] / [1.85:1] / [2.35:1]

Safety Zone: Sets the safety zone display. This becomes the standard range that can be received by a general household TV.
[Off] / [80%] / [90%]

Guideframe: Sets whether or not to display the guide frame. You can verify whether the subject is level or perpendicular to the ground.
[Off] / [On]

Hint

- You can display several markers at the same time.
- Place the subject on the cross point of the [Guideframe] to make a balanced composition.

4K Output Select

You can set how to record movies and perform HDMI output when your camera is connected to 4K-compatible external recording/playback devices, etc.

1 Turn the mode dial to  (Movie).

2 Connect the camera to the desired device via an HDMI cable.

3 MENU →  (Setup) →  [4K Output Select] → desired setting.

Memory Card+HDMI: Simultaneously outputs to the external recording/playback device and records on the camera's memory card.



HDMI Only (30p): Outputs a 4K movie in 30p to the external recording/playback device without recording on the camera's memory card.

HDMI Only (24p): Outputs a 4K movie in 24p to the external recording/playback device without recording on the camera's memory card.

HDMI Only (25p)*: Outputs a 4K movie in 25p to the external recording/playback device without recording on the camera's memory card.

* Only when [NTSC/PAL Selector] is set to PAL.

Note

- This item can be set only when the camera is in movie mode and connected to a 4K-compatible device.
- When [HDMI Only (30p)], [HDMI Only (24p)] or [HDMI Only (25p)] is set, [HDMI Info. Display] will temporarily be set to [Off].
- A 4K movie is not output to the connected 4K-compatible device during slow-motion/quick-motion shooting.
- When [HDMI Only (30p)], [HDMI Only (24p)] or [HDMI Only (25p)] is set, the counter does not move forward (the actual recording time is not counted) while the movie is being recorded on an external recording/playback device.
- When shooting 4K movies using the setting [Memory Card+HDMI], the movies will not be output to a device connected by HDMI cable if you simultaneously record a proxy movie. If you want to perform HDMI output, set [ Proxy Recording] to [Off]. (In this case, if you set [ Record Setting] to other values except [24p], the image will not be displayed on the screen of the camera).

- When [File Format] is set to [XAVC S 4K] and the camera is connected via HDMI, the following functions are partially restricted.
 - [Face/Eye Priority in AF]
 - [Face Priority in Multi Metering]
 - Tracking function

Px Proxy Recording

Sets whether to simultaneously record low-bit-rate proxy movies when recording XAVC S movies.

Since proxy movies are small in file size, they are suitable for transferring to smartphones or uploading to websites.

MENU →  **2 (Camera Settings 2)** → [**Px** Proxy Recording] → **desired setting.**

On: Proxy movies are simultaneously recorded.

Off: Proxy movies are not recorded.

Hint

- Proxy movies are recorded in the XAVC S HD format (1280×720) at 9 Mbps. The frame rate of the proxy movie is the same as that of the original movie.
- Proxy movies are not displayed on the playback screen (single-image playback screen or image index screen). **Px** is displayed over movies for which a proxy movie was simultaneously recorded.

Note

- Proxy movies cannot be played back on this camera.
- Proxy recording is not available in the following situations.
 - When [File Format] is set to [AVCHD]
 - When [File Format] is set to [XAVC S HD] and [Record Setting] is set to [120p]/[100p]
- Deleting/protecting movies that have proxy movies removes/protects both the original and proxy movies. You cannot delete/protect only original movies or proxy movies.
- Movies cannot be edited on this camera.
- For details on memory cards that can be used, refer to page 248.

Viewing images

Playing back still images

Plays back the recorded images.

1 Press the  (Playback) button to switch to the playback mode.

2 Select the image with the control wheel.

- Images shot with continuous shooting or interval shooting are displayed as one group. To play back the images in the group, press the center of the control wheel.
-

Hint

- The product creates an image database file on a memory card to record and play back images. An image that is not registered in the image database file may not be played back correctly. To play back images shot using other devices, register those images to the image database file using MENU →  (Setup) → [Recover Image DB].
- If you play back the images right after continuous shooting, the monitor may display an icon indicating that data is being written/the number of images left to write (page 233). During writing, some functions are not available.
- You can also enlarge an image by double-tapping the monitor. In addition, you can drag and move the magnified position on the monitor. Set [Touch Operation] to [On] beforehand.

Enlarging an image being played back (⊕ Enlarge Image)

Enlarges the image being played back. Use this function to check the focus of the image, etc.

1 Display the image you want to enlarge, and then press the ⊕ button.

- Turn the control wheel to adjust the zoom scale. By rotating the front/rear dial, you can switch to the previous or next image while keeping the same zoom scale.
- The view will zoom in on the part of the image where the camera focused during shooting. If the focus location information cannot be obtained, the camera will zoom in on the center of the image.

2 Select the portion you want to enlarge by pressing the top/bottom/right/left sides of the control wheel.

3 Press the MENU button or the center of the control wheel to exit the playback zoom.

Hint

- You can also enlarge an image being played back using MENU.
- You can change the initial magnification and initial position of enlarged images by selecting MENU →  (Playback) → [⊕ Enlarge Initial Mag.] or [⊕ Enlarge Initial Position].
- You can also enlarge an image by double-tapping the monitor. In addition, you can drag and move the magnified position on the monitor. Set [Touch Operation] to [On] beforehand.

Note

- You cannot enlarge movies.

Rotating recorded images automatically (Display Rotation)

Selects the orientation when playing back recorded images.

MENU →  (**Playback**) → [**Display Rotation**] → **desired setting**.

Auto: When you rotate the camera, the displayed image rotates automatically by detecting the orientation of the camera.

Manual: Images shot vertically are displayed vertically. If you have set the image orientation using the [Rotate] function, the image will be displayed accordingly.

Off: Images are always displayed horizontally.

Note

- Movies shot vertically are played back horizontally on the monitor or the viewfinder of the camera during movie playback.

Playing back movies









Plays back the recorded movies.





1 Press the  (**Playback**) button to switch to playback mode.

2 Select the movie to be played back using the control wheel and press the center of the control wheel to start playback.

Available operations during movie playback

You can perform slow playback and sound volume adjustment, etc. by pressing the down side of the control wheel.

Operation panel	Available operation
	Playback
	Pause
	Fast-forward
	Fast-rewind
	Forward slow playback
	Reverse slow playback
	Next movie file
	Previous movie file

Operation panel	Available operation
	Displays the next frame
	Displays the previous frame
	Photo Capture
	Sound volume adjustment
	Closes the operation panel

Hint

- “Forward slow playback,” “Reverse slow playback,” “Displays the next frame” and “Displays the previous frame” are available during pause.
- Movie files recorded using other products may not be able to be playable on this camera.

Note

- Movies shot vertically are played back horizontally on the monitor or the viewfinder of the camera during movie playback.

Photo Capture

Captures a chosen scene in a movie to save as a still image. First shoot a movie, then pause the movie during playback to capture decisive moments that tend to be missed when shooting still images, and save them as still images.

1 Display the movie that you want to capture as a still image.

2 MENU →  (Playback) → [Photo Capture].

-
- 3 Play back the movie and pause it.**

 - 4 Find the desired scene using forward slow playback, reverse slow playback, displays the next frame, and displays the previous frame, and then stop the movie.**

 - 5 Press  (Photo Capture) to capture the chosen scene.**
The scene is saved as a still image.
-

Playing back images on the image index screen (Image Index)

You can display multiple images at the same time in playback mode.

-
- 1 Press the  (Image Index) button while the image is being played back.**

 - 2 Select the image by pressing the top/bottom/right/left sides of the control wheel or turning the control wheel.**
-

■ To change the number of images to be displayed

MENU →  (Playback) → [Image Index] → desired setting.

9 Images/25 Images

■ To return to single-image playback

Select the desired image and press the center of the control wheel.

■ To display a desired image quickly

Select the bar on the left of the image index screen using the control wheel, then press the top/bottom sides of the control wheel. While the bar is being selected, you can display the calendar screen or folder selection screen by pressing the center. In addition, you can switch View Mode by selecting an icon.

Setting the method for jumping between images (Image Jump Setting)

Sets which dial and method to use for jumping between images during playback. This function is useful when you want to find one of many recorded images. You can also quickly find protected images or images set with a particular rating (page 170).

MENU →  (**Playback**) → **[Image Jump Setting]** → **desired item.**

Select Dial: Selects the dial to use for jumping between images.

Image Jump Method: Sets the method for playing back with Image Jump.

Note

- A group is counted as an image when [Image Jump Method] is set to [One by one], [By 10 images], or [By 100 images].
- When [Image Jump Method] is set to a parameter other than [One by one], [By 10 images], or [By 100 images], Image Jump will only be available if [View Mode] is set to [Date View]. If [View Mode] is not set to [Date View], the camera will always play back every image without jumping when you use the dial selected with [Select Dial].
- When you use the Image Jump function and [Image Jump Method] is set to a parameter other than [One by one], [By 10 images], or [By 100 images], movie files are always skipped.

Switching between still images and movies (View Mode)

Sets the View Mode (image display method).

MENU →  (Playback) → [View Mode] → desired setting.

Date View: Displays the images by date.

Folder View (Still): Displays only still images.



AVCHD View: Displays only AVCHD-format movies.

XAVC S HD View: Displays only XAVC S HD-format movies.

XAVC S 4K View: Displays only XAVC S 4K-format movies.



Cont. PB for Interval

Continuously plays back images shot using interval shooting (page 90). You can create movies from still images produced by interval shooting using the computer software Imaging Edge (Viewer). You cannot create movies from the still images on the camera.

1 **MENU** →  (Playback) → [Cont. PB for  Interval].

2 Select the image group that you want to play back, and then press the center of the control wheel.

Hint

- On the playback screen, you can start continuous playback by pressing the down button while displaying an image in the group.
- You can resume play or pause by pressing the down button during playback.
- You can change the playback speed by turning the front/rear dial or the control wheel during playback. You can also change the playback speed by selecting **MENU** →  (Playback) → [PB Speed for  Interval].
- You can continuously play back images shot with continuous shooting as well.

Selecting which memory card to play back (Select Playback Media)

Selects the memory card slot to be played back.

MENU →  (**Playback**) → [**Select Playback Media**] → **desired slot**.

Slot 1: Selects the slot 1.

Slot 2: Selects the slot 2.

Note

- No image is played back when no memory card is inserted in the selected slot. Select a slot into which a memory card has been inserted.
- When you select [Date View] in [View Mode], the camera only plays back images from a memory card selected using [Select Playback Media].

Copying images from one memory card to another (Copy)

You can copy images from a memory card in a slot that is selected using [Select Playback Media] to a memory card in another slot.

MENU →  (**Playback**) → [**Copy**].

All of the contents with a date or in a folder currently being played back will be copied to a memory card in another slot.

Hint

- You can select the type of images to be displayed by selecting **MENU** →  (**Playback**) → [View Mode].

Note

- If images in a group are copied, the copied images will not be displayed as a group on the destination memory card.
- If protected images are copied, the protection will be canceled on the destination memory card.
- It may take a long time when many images are to be copied. Use a sufficiently charged battery pack.
- XAVC S movies can only be copied to a memory card that supports XAVC S movies. A message will be displayed on the monitor of the camera when images cannot be copied.

Playing back images using slideshow (Slide Show)

Automatically plays back images continuously.

1 MENU → (Playback) → [Slide Show] → desired setting.

Repeat: Select [On], in which images are played back in a continuous loop, or [Off], in which the product exits the slideshow when all the images are played back once.

Interval: Select the display interval for images from among [1 Sec], [3 Sec], [5 Sec], [10 Sec] or [30 Sec].

2 Select [Enter].

To quit the slideshow in the middle of playback

Press the MENU button to quit the slideshow. You cannot pause the slideshow.

Hint

- During playback, you can display the next/previous image by pressing the right/left side of the control wheel.
- You can activate a slideshow only when [View Mode] is set to [Date View] or [Folder View (Still)].

Protecting images (Protect)

Protects recorded images against accidental erasure. The  mark is displayed on protected images.

MENU →  (Playback) → [Protect] → desired setting.

Multiple Img.: Applies or cancels the protection of the selected multiple images.

All in this Folder: Protects all images in the selected folder.

All with this date: Protects all images taken on the selected date.



Cancel All in this Folder: Cancels the protection of all images in the selected folder.

Cancel All with this date: Cancels the protection of all images taken on the selected date.

All Images in This Group: Protects all the images in the selected group.

Cancel All in This Group: Cancels the protection of all the images in the selected group.

Hint

- If you assign [Protect] to the key of your choice using MENU →  2 (Camera Settings2) →  Custom Key], you can protect images or cancel protection by simply pressing the key. The [Protect] function is assigned to the C3 button in the default settings.
- If you select a group in [Multiple Img.], all the images in the group will be protected. To select and protect particular images within the group, execute [Multiple Img.] while displaying the images within the group.

Note

- The menu items that can be selected vary according to the [View Mode] setting and the selected content.

■ Multiple Img.

- ① Select the image to be protected, then press the center of the control wheel. The ✓ mark is displayed in the check box. To cancel the selection, press the center again to remove the ✓ mark.
- ② To protect other images, repeat step ①.
- ③ MENU → [OK].

Setting rating function

You can assign ratings to recorded images on a scale from ★ to ★★ to make it easier to find images. Combining this function with [Image Jump Setting] allows you to find a desired image quickly.

1 MENU →  (Playback) → [Rating].

The image rating selection screen will appear.

2 Press the left/right sides of the control wheel to display an image to which you want to assign a rating, and then press the center.

3 Select the number of ★ (Rating) by pressing the left/right sides of the control wheel, and then press the center.

4 Press the MENU button to exit the rating setting screen.

Hint

- You can also assign ratings when playing back images by using the custom key. Assign [Rating] to the desired key using [ Custom Key] beforehand, and then press the custom key while playing back an image to which you want to assign a rating. The number of ★ (Rating) changes each time you press the custom key.

Note

- You can assign ratings to still images only.

■ Rating Set (Custom Key)

Sets the available number of ★ when rating images with the key to which you have assigned [Rating] using [▶ Custom Key].

- ① **MENU** → **▶ (Playback)** → **[Rating Set (Custom Key)]**.
- ② **Add a ✓ mark to the number of ★ that you want to activate.**

You can select the checked number when setting [Rating] using the custom key.

Attaching audio files to images (Voice Memo)

You can record shooting conditions or image descriptions with your voice, and attach the audio file to images as voice memos.

Voice memos can be transferred to a computer together with images, and played back on the computer.

1 MENU → (Playback) → [Voice Memo].

The image selection screen will appear.

2 Select a still image to which you want to attach a voice memo.

3 While pressing the center of the control wheel, record your voice.

A voice memo file (.WAV) with the same file name as the still image will be saved in the folder where the corresponding still image is saved.

- Recording continues while the center of the control wheel is pressed. The recording stops when the button is released.
-

■ To play back voice memos

① MENU → (Playback) → [Voice Memo].

② Select a still image to which a voice memo you want to play back is attached.

-  is displayed on still images having attached voice memos.

③ Press the center of the control wheel.

■ To delete voice memos

- ① **MENU** →  (Playback) → [Voice Memo].
- ② **Select a still image to which a voice memo you want to delete is attached.**
- ③ **Press the bottom of the control wheel, and then select [OK].**

Hint

- If you assign [Voice Memo hold] to a custom key using [ Custom Key], a voice memo will be recorded while the key is being pressed. If you assign [Voice Memo toggle] to a custom key, voice memo recording will start when you press the key, and stop when you press the key again. During voice memo playback, playback will start when the key is pressed, and stop when it is pressed again.
- You can still record a voice memo for a protected still image.

Note

- You cannot attach a voice memo to a movie.
- One voice memo file of up to 60 seconds in duration can be attached per still image.
- You cannot add another voice memo to a still image to which a voice memo has already been attached, or overwrite the content of a voice memo that has already been attached. First delete the attached voice memo, and then record a new voice memo.
- You cannot change the microphone input level for recording.
- The built-in microphone is used for voice memo recording. You cannot use an external audio input device.

Deleting images

Deleting a displayed image

You can delete an image displayed. Once you have deleted an image, you cannot restore it. Confirm the image to be deleted beforehand.

1 Display the image you want to delete.

2 Press the  (Delete) button.

3 Select [Delete] using the control wheel.

- If a voice memo is attached to the image to be deleted, select [Delete image and voice memo].
-

Note

- The protected images cannot be deleted.

Deleting multiple selected images (Delete)

You can delete multiple selected images. Once you have deleted an image, you cannot restore it. Confirm the image to be deleted beforehand.

MENU →  (Playback) → [Delete] → **desired setting.**

Multiple Img.: Deletes the selected images.

All in this Folder: Deletes all images in the selected folder.

All with this date: Deletes all images taken on the selected date.

All Other Than This Img.: Deletes all images in the group except the selection.

All Images in This Group: Deletes all images in the selected group.

Hint

- Perform [Format] to delete all images, including protected images.
- To display the desired folder or date, select the desired folder or date during playback by performing the following procedure:
 (Image Index) button → select the bar on the left using the control wheel → select the desired folder or date using the top/bottom sides of the control wheel.
- If you select a group in [Multiple Img.], all the images in the group will be deleted. To select and delete particular images within the group, execute [Multiple Img.] while displaying the images within the group.

Note

- The protected images cannot be deleted.
- The menu items that can be selected vary according to the [View Mode] setting and the selected content.

Multiple Img.

- ① **Select the images to be deleted, then press the center of the control wheel. The ✓ mark is displayed in the check box. To cancel the selection, press the center again to remove the ✓ mark.**
- ② **To delete other images, repeat step ①.**
- ③ **MENU → [OK].**

Registering frequently used functions

MR 1/2 Memory

Allows you to register up to 3 often-used modes or product settings to the product and up to 4 (M1 through M4) to the memory card. You can recall the settings using just the mode dial.

1 Set the product to the setting you want to register.

2 MENU → 1 (Camera Settings 1) → [**MR** 1/2 Memory] → desired number.

3 Press the center of the control wheel to confirm.

Items that can be registered

- You can register various functions for shooting. The items that can actually be registered are displayed on the menu of the camera.
- Aperture (F number)
- Shutter speed

To change registered settings

Change the setting to the desired one and re-register the setting to the same mode number.

Note

- M1 through M4 can be selected only when a memory card is inserted into the product.
- When registering the settings on a memory card, only a memory card that has been selected using [**MR** Select Media] can be used.
- Program Shift cannot be registered (page 103).
- For some functions, the position of the dial and the setting actually used for shooting may not match. If this happens, shoot images by referring to the information displayed on the monitor.

Registering shooting settings to a custom key (Reg. Custom Shoot Set)

You can register shooting settings (such as exposure, focus setting, drive mode, etc.) to a custom key in advance and temporarily recall them while holding down the key. Simply press the custom key to switch the settings quickly and release the key to go back to the original settings. This function is useful when recording active scenes such as sports.

- 1 MENU →  1 (Camera Settings 1) → [Reg. Custom Shoot Set] → Select a registration number from [Recall Custom hold 1] to [Recall Custom hold 3].**

The setting screen for the selected number will be displayed.

- 2 Using the top/bottom/left/right side of the control wheel, select the check boxes for the functions that you want to recall with one of the registration numbers and press the center to check each box.**

A  mark will be displayed in the boxes for the functions.

- To cancel a selection, press the center again.

- 3 Select the function that you want to adjust using the top/bottom/left/right side of the control wheel, and press the center to adjust the function to the desired setting.**



- Select [Import Current Setting] to register the current settings of the camera to the registration number that you chose.

- 4 Select [Register].**

Items that can be registered

- You can register various functions for shooting. The items that can actually be registered are displayed on the menu of the camera.
- Exposure
- Focus setting
- Drive mode (other than self-timer)

To recall registered settings

① **MENU** →  2 (Camera Settings 2) →  Custom Key] → Select the desired key and then select one of the registration numbers from [Recall Custom hold 1] to [Recall Custom hold 3].

② **On the shooting screen, press the shutter button while holding down the key to which you assigned one of the registration numbers.**

The registered settings are activated while you are holding down the custom key.

Hint

- You can change the settings for [Reg. Custom Shoot Set] after assigning one of the registration numbers to the custom key using  Custom Key].

Note

- The registration numbers [Recall Custom hold 1] through [Recall Custom hold 3] are available only when the shooting mode is set to P/A/S/M.
- Depending on the attached lens and the status of the camera when the registered setting recall is executed, the registered settings may not take effect.

Assigning frequently used functions to buttons (Custom Key)

You can use the custom key function to assign the functions you use most frequently to easily operable keys. This lets you skip the process of selecting items from MENU, so you can recall the functions more quickly. You can also assign [Not set] to easily operable keys to prevent accidental operation.

You can separately assign functions to custom keys for the still image shooting mode (📷 Custom Key), movie shooting mode (🎥 Custom Key), and playback mode (▶ Custom Key).

- Assignable functions vary depending on the keys.

You can assign functions to the following keys.

- 1 AF-ON Button
- 2 Custom Button 3
- 3 Custom Button 2
- 4 Custom Button 1
- 5 AEL Button
- 6 Center Button
- 7 Control Wheel / Left Button / Right Button / Down Button
- 8 Custom Button 4
- 9 Multi-Slc Center Btn
- 10 Fn/📷 Button

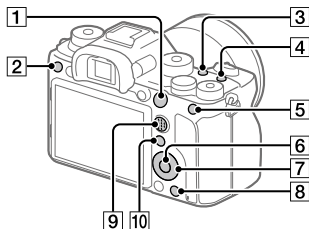



Hint

- You can recall functions more quickly by using the Function menu (page 26) to configure each setting directly from the Fn button, along with the custom keys.

The following is the procedure for assigning the [Eye AF] function to the AEL button.

1 MENU →  2 (Camera Settings 2) →  Custom Key].







- If you want to assign a function to recall while shooting movies, select [ Custom Key]. If you want to assign a function to recall while playing back images, select [ Custom Key].
-

2 Move to the [Rear1] screen using the left/right side of the control wheel. Then, select [AEL Button] and press the center of the control wheel.

3 Press the left/right side of the control wheel until [Eye AF] is displayed. Select [Eye AF], and then press the center.

- If you press the AEL button in the still image shooting mode and eyes are detected, [Eye AF] will activate, and the camera will focus on the eyes. Shoot images while holding down the AEL button.
-

Note

- You can also assign shooting functions to the focus hold button on the lens. However, some lenses do not have a focus hold button.
- If you assign [Follow Custom ()] to a custom key using [ Custom Key], but the function is one that is unavailable in the movie shooting mode such as [ JPEG Quality] or [Flash Mode], the function will not be recalled when you press the key in the movie shooting mode.
- If you assign [Follow Custom (/)] to a custom key using [ Custom Key], the camera will switch to the shooting mode and recall the assigned function when you press the key in the playback mode.



Customizing the functions of the dial

Changing the function of the dial temporarily (My Dial Settings)



You can assign the desired functions to the front dial, rear dial, and control wheel, and register up to three combinations of settings as “My Dial” settings. You can quickly recall or switch registered “My Dial” settings by pressing the custom key you assigned in advance.

■ Registering functions to “My Dial”

Register the functions that you want to assign to the front dial, the rear dial, and the control wheel as [My Dial 1] through [My Dial 3].



- ① **MENU** →  **2 (Camera Settings 2)** → **[My Dial Settings]**.
- ② **Select a dial or wheel for  (My Dial 1), and press the center of the control wheel.**
- ③ **Select the desired function to assign using the top/bottom/left/right sides of the control wheel, and then press the center of the control wheel.**
 - Select “--” (Not set) for a dial or wheel to which you do not want to assign any function.
- ④ **After you select functions for all of the dials and the wheel in  (My Dial 1) by repeating Steps ② and ③, select [OK].**

The settings for  (My Dial 1) will be registered.

 - If you want to register  (My Dial 2) and  (My Dial 3) as well, follow the same procedure as described above.

Assigning a key to recall “My Dial”

Assign a custom key to recall the registered “My Dial” settings.

- ① **MENU** →  **2 (Camera Settings 2)** →  **Custom Key** or  **Custom Key** → **Select the key that you want to use to recall “My Dial.”**
- ② **Select the number of the “My Dial” setting that you want to recall or the pattern for switching “My Dial.”**

My Dial 1 during Hold / My Dial 2 during Hold

/ My Dial 3 during Hold: While you hold down the key, the functions that you registered in [My Dial Settings] are assigned to the dial/wheel.

My Dial 1→2→3: Each time you press the key, the function changes in the following sequence: “Normal function → Function of My Dial 1 → Function of My Dial 2 → Function of My Dial 3 → Normal function.”

Toggle My Dial 1 / Toggle My Dial 2 / Toggle My Dial 3: The function registered using [My Dial Settings] is maintained even if you do not hold down the key. Press the key again to return to the normal function.

Shooting while switching “My Dial”

During shooting, you can recall “My Dial” using the custom key, and shoot as you change the shooting setting by turning the front dial, the rear dial, and the control wheel.

Note

- “My Dial” settings in which every dial/wheel is set to [Not set] are not recalled when you press the custom key. They are also skipped in [My Dial 1→2→3].
- Even if a dial/wheel has been locked using the [Lock Operation Parts] function, it will be unlocked temporarily when “My Dial” is recalled.

Customizing the MENU (My Menu)

Add Item

You can register the desired menu items to ★ (My Menu) under MENU.

- 1 MENU → ★ (My Menu) → [Add Item].**
- 2 Select an item that you want to add to ★ (My Menu) using the top/bottom/left/right sides of the control wheel.**
- 3 Select a destination using the top/bottom/left/right sides of the control wheel.**

Hint

- You can add up to 30 items to ★ (My Menu).

Note

- You cannot add the following items to ★ (My Menu).
 - Any item under MENU →  (Playback)
 - [View on TV]

Sort Item

You can rearrange menu items added to ★ (My Menu) under MENU.

- 1 MENU → ★ (My Menu) → [Sort Item].**
- 2 Select an item that you want to move using the top/bottom/left/right sides of the control wheel.**
- 3 Select a destination using the top/bottom/left/right sides of the control wheel.**

Delete Item

You can delete menu items added to ★ (My Menu) of MENU.

1 MENU → ★ (My Menu) → [Delete Item].

2 Select an item that you want to delete using the top/bottom/left/right sides of the control wheel, and then press the center to delete the selected item.

Hint

- To delete all the items on a page, select MENU → ★ (My Menu) → [Delete Page].
- You can delete all the items added to ★ (My Menu) by selecting MENU → ★ (My Menu) → [Delete All].

Display From My Menu

You can set My Menu to appear first when you press the MENU button.

MENU → ★ (My Menu) → [Display From My Menu] → **desired setting.**

On: My Menu appears first when you press the MENU button.

Off: The most recently displayed menu appears when you press the MENU button.

Checking images before/after recording

Auto Review

You can check the recorded image on the screen right after the shooting. You can also set the display time for Auto Review.

MENU →  **2 (Camera Settings 2)** → **[Auto Review]** → **desired setting.**

10 Sec/5 Sec/2 Sec: Displays the recorded image on the screen right after shooting for the selected duration of time. If you perform a magnifying operation during Auto Review, you can check that image using the magnified scale.

Off: Does not display the Auto Review.

Note

- When you use a function that performs image processing, the image before processing may be displayed temporarily, followed by the image after processing.
- The DISP (Display Setting) settings are applied for the Auto Review display (page 31).

Aperture Preview

While you press and hold the key to which you assigned the [Aperture Preview] function, the aperture is stepped down to the set aperture value and you can check the blurriness prior to shooting.

1 **MENU** →  **2 (Camera Settings 2)** → **[ Custom Key]** → **set the [Aperture Preview] function to the desired key.**

2 **Confirm the image by pressing the key to which [Aperture Preview] was assigned.**

Hint

- Although you can change the aperture value during the preview, the subject may be defocused if you select a brighter aperture. We recommend that you adjust the focus again.

Shot. Result Preview

While pressing down the key to which [Shot. Result Preview] is assigned, you can check the image preview with the DRO, shutter speed, aperture and ISO sensitivity settings applied. Check the shooting result preview before shooting.

1 MENU →  2 (Camera Settings 2) → [ Custom Key] → set the [Shot. Result Preview] function to the desired key.

2 Confirm the image by pressing the key to which [Shot. Result Preview] was assigned.

Hint

- The DRO settings, shutter speed, aperture and ISO sensitivity settings you have set are reflected on the image for [Shot. Result Preview], but some effects cannot be previewed depending on the shooting settings. Even in that case, the settings you have selected will be applied to the images you shoot.

Monitor/viewfinder settings

FINDER/MONITOR

Sets the method for switching the display between the viewfinder and the monitor.





MENU →  2 (Camera Settings 2) → [FINDER/MONITOR] → **desired setting.**

Auto: When you look into the viewfinder, the eye sensor reacts and the display is switched to the viewfinder automatically.

Viewfinder (Manual): The monitor is turned off and the image is displayed only in the viewfinder.

Monitor (Manual): The viewfinder is turned off and the image is always displayed on the monitor.

Hint

- You can assign the [FINDER/MONITOR] function to your preferred key. MENU →  2 (Camera Settings 2) → [ Custom Key], [ Custom Key] or [ Custom Key] → set [Finder/Monitor Sel.] to the preferred key.
- If you want to retain the viewfinder display or the monitor display, set [FINDER/MONITOR] to [Viewfinder (Manual)] or [Monitor (Manual)] beforehand.



You can keep the monitor off when you take your eyes off the viewfinder during recording by setting the monitor display to [Monitor Off] using the DISP button. Select MENU →  2 (Camera Settings 2) → [DISP Button] → [Monitor] and add a check mark to [Monitor Off] beforehand.

Note

- When the monitor is pulled out, the eye sensor of the camera will not detect your eye approaching even if [FINDER/MONITOR] is set to [Auto]. The image will continue to be displayed on the monitor.

Finder Frame Rate

Display the subject's movements more smoothly by adjusting the frame rate of the viewfinder during still image shooting. This function is convenient when shooting a fast-moving subject.





MENU →  2 (Camera Settings 2) → [ Finder Frame Rate] → **desired setting.**

- This function can be assigned to key of your choice using [ Custom Key].

Standard: Displays the subject at a normal frame rate on the viewfinder.

High: Displays the movements of the subject more smoothly on the viewfinder.

Note

- When [ Finder Frame Rate] is set to [High], the resolution of the viewfinder is lowered.
- Even when [ Finder Frame Rate] is set to [High], the setting may switch to [Standard] automatically depending on the temperature of the shooting environment and the shooting conditions.
- [ Finder Frame Rate] is locked to [Standard] in the following situations:
 - During playback
 - During HDMI connection
 - When the temperature inside the camera's body is high
 - During continuous shooting with [ Shutter Type] set to [Auto] or [Electronic Shutter].

Memory card settings

Format

When you use a memory card with this camera for the first time, we recommend that you format the card using the camera for stable performance of the memory card. Note that formatting permanently erases all data on the memory card, and is unrecoverable. Save valuable data on a computer, etc.

MENU →  (Setup) → [Format] → desired memory card slot.

Note

- Formatting permanently erases all data including protected images and registered settings (from M1 to M4) (page 176).
- The access lamp lights up during formatting. Do not remove the memory card while the access lamp is lit up.
- Format the memory card on this camera. If you format the memory card on the computer, the memory card may not be usable depending on the format type.
- It may take a few minutes to complete formatting, depending on the memory card.
- You cannot format the memory card if the remaining battery charge is less than 1%.

File/Folder Settings

Sets file names for still images to be shot, and specifies folders for storing the shot still images.

MENU →  (Setup) → [ File/Folder Settings] → desired setting.

File Number: You can set how to assign file numbers to still images.

[Series]: Does not reset file numbers for each folder.

[Reset]: Resets file numbers for each folder.

Set File Name: You can specify the first three characters of the file name.

Folder Name: You can set how folder names are assigned.

[Standard Form]: Folders are named as "folder number + MSDCF."

Example: 100MSDCF

[Date Form]: Folders are named as "folder number + Y (the last digit of the year)/MM/DD."

Example: 10090405 (Folder number: 100; date: 04/05/2019)

Hint

- The settings for [File Number] and [Set File Name] are applied to both Slot 1 and Slot 2.
- When [File Number] is set to [Series], file numbers will be assigned sequentially across the memory cards in the slots even if you change the [Prioritize Rec. Media] setting.

Note

- Only capital letters, numbers, and underscores can be used for [Set File Name]. Underscores cannot be used for the first character.
- The three characters specified using [Set File Name] are only applied to files recorded after the setting is made.
- When [Folder Name] is set to [Date Form], you cannot select the folder where files are stored.
- If [Recording Mode] under [Rec. Media Settings] is set to a parameter other than [Standard], only folders shared by both memory cards may be selectable. If you cannot find a shared folder, you can create one using [New Folder].
- If [Recording Mode] under [Rec. Media Settings] is set to a parameter other than [Standard], a folder numbered with the previous folder number on the memory card +1 will be created on both memory cards.
- When you shoot images with [Recording Mode] under [Rec. Media Settings] set to a parameter other than [Standard], a new folder may be automatically created.
- A new folder may be automatically created if you shoot images using a memory card that has been used in another device.
- Up to 4,000 images in total can be stored in one folder. When the folder capacity is exceeded, a new folder may be automatically created.

File Settings

Configure settings for the file names of recorded movies.

MENU →  (Setup) →  **File Settings** → **desired setting.**

File Number: You can set how to assign file numbers to movies.

[Series]: Does not reset file numbers even if the memory card is changed.

[Reset]: Resets the file number when the memory card is changed.

Series Counter Reset: Resets the series counter used when [File Number] is set to [Series].

File Name Format: You can set the format for movie file names.

[Standard]: The file name of the recorded movie starts with "C."

Example: C0001

[Title]: The file name of the recorded movie becomes "Title+File number."

[Date+Title]: The file name of the recorded movie becomes "Date+Title+File number."

[Title+Date]: The file name of the recorded movie becomes "Title+Date+File number."

Title Name Settings: You can set the title when [File Name Format] is set to [Title], [Date+Title], or [Title+Date].

Hint

- The settings for [File Number] and [File Name Format] are applied to both Slot 1 and Slot 2.
- When [File Number] is set to [Series], file numbers will be assigned sequentially across the memory cards in the slots even if you change the [Prioritize Rec. Media] setting.

Note

- Only alphanumeric characters and symbols can be input for [Title Name Settings]. Up to 37 characters can be entered.
- Titles specified using [Title Name Settings] are only applied to movies recorded after the setting is made.
- [File Settings] does not apply to AVCHD movies.
- You cannot set how folder names are assigned for movies.
- If you are using an SDHC memory card, [File Name Format] is locked to [Standard].
- If there are unused numbers due to file deletion, etc., these numbers will be reused when the movie file number reaches "9999."

Rec. Media Settings

Prioritize Rec. Media

Selects the memory card slot on which to record.

[Slot 1] is the default setting. If you do not intend to change the settings and will only use one memory card, use the slot 1.

MENU →  (**Setup**) → **[Rec. Media Settings]** → **[Prioritize Rec. Media]** → **desired slot.**

Slot 1: Selects media in the slot 1.

Slot 2: Selects media in the slot 2.

Hint

- To record the same image on two memory cards at the same time or to sort recorded images onto two memory card slots by the image type (still image/movie), use [Recording Mode].

Recording Mode

You can select the method for recording an image, such as recording the same image simultaneously to two memory cards or recording different types of images to two memory cards.

MENU →  (Setup) → [Rec. Media Settings] → [Recording Mode] → desired setting.

Standard: Records an image to a memory card in the memory card slot that you select in [Prioritize Rec. Media].



Simult. (): Records a still image to both memory cards and records a movie to a memory card in the memory card slot that you select in [Prioritize Rec. Media].

Simult. (): Records a still image to a memory card in the memory card slot that you select in [Prioritize Rec. Media], and records a movie to both memory cards.

Simult. (/): Records a still image and a movie to both memory cards.

Sort (RAW/JPEG): Records an image in RAW format to a memory card in the memory card slot that you select in [Prioritize Rec. Media], and records an image in JPEG format to the other memory card. Movies are recorded to the memory card in the memory card slot that you selected in [Prioritize Rec. Media].

Sort (JPEG/RAW): Records an image in JPEG format to a memory card in the memory card slot that you select in [Prioritize Rec. Media], and records an image in RAW format to the other memory card. Movies are recorded to the memory card in the memory card slot that you selected in [Prioritize Rec. Media].

Sort (/): Records a still image to a memory card in the memory card slot that you select in [Prioritize Rec. Media], and records a movie to the other memory card.

Hint

- Even when [Recording Mode] is set to [Sort (RAW/JPEG)] or [Sort (JPEG/RAW)], if [RAW & JPEG] is not selected under [ File Format], only files of the selected format will be recorded.

■ Auto Switch Media

If a memory card in use becomes full or you have forgotten to insert a memory card into a slot, you can record images to the other memory card. For details on how the memory card slot to which images are recorded changes, refer to the "Help Guide" (page 2).

MENU →  (**Setup**) → **[Rec. Media Settings]** → **[Auto Switch Media]** → **desired setting.**

On: The camera automatically starts recording on the other memory card when a memory card in use becomes full or if you have forgotten to insert a memory card.

Off: The camera does not perform [Auto Switch Media].

Hint

- Images are recorded to the memory card in the slot displayed on the monitor with an arrow symbol. After the camera switches the slot using [Auto Switch Media], replace the memory card in the former slot with a recordable memory card.
- If [Recording Mode] is set to [Standard], the setting for [Prioritize Rec. Media] will switch automatically when the slot switches. If you want to record on the slot in use before switching, select the desired slot again using [Prioritize Rec. Media].
- If you want to continually record with the settings selected with [Recording Mode] and [Prioritize Rec. Media], set [Auto Switch Media] to [Off].

Camera settings

Power Save Start Time

Sets time intervals to automatically switch to power save mode when you are not performing operations to prevent wearing down the battery pack. To return to shooting mode, perform an operation such as pressing the shutter button halfway down.

MENU →  (Setup) → [Power Save Start Time] → desired setting.

30 Min/5 Min/2 Min/1 Min/10 Sec

Note

- Turn off the product when you do not use it for a long time.
- The power save function is deactivated in the following situations:
 - While power is being supplied via USB
 - While playing back slideshows
 - During FTP transfer
 - While recording movies
 - While connected to a computer or TV
 - When [IR Remote Ctrl] is set to [On]
 - When [Bluetooth Rmt Ctrl] is set to [On]

IR Remote Ctrl

You can operate this product and shoot images using the SHUTTER button, 2SEC button (2 second delay shutter), and START/STOP button (or Movie button (RMT-DSLR2 only)) on the Wireless Remote Commander RMT-DSLR1 (sold separately) and RMT-DSLR2 (sold separately). Refer also to the operating instructions for the Infrared Remote Commander.

MENU →  (Setup) → [IR Remote Ctrl] → desired setting.

On: Allows infrared remote commander operation.

Off: Does not allow infrared remote commander operation.

Note

- The lens or lens hood may block the infrared remote sensor that receive the signals. Use the infrared remote commander in the position from which the signal can reach the product.
- When [IR Remote Ctrl] is set to [On], the product does not switch to power save mode. Set [Off] after using an infrared remote commander.
- An infrared remote commander cannot be used while [Bluetooth Rmt Ctrl] is set to [On].

HDMI Settings

HDMI Resolution

When you connect the product to a High Definition (HD) TV with HDMI terminals using an HDMI cable (sold separately), you can select HDMI Resolution to output images to the TV.

MENU →  (**Setup**) → **[HDMI Settings]** → **[HDMI Resolution]** → **desired setting.**

Auto: The product automatically recognizes an HD TV and sets the output resolution.

2160p/1080p: Outputs signals in 2160p/1080p.

1080p: Outputs signals in HD picture quality (1080p).



1080i: Outputs signals in HD picture quality (1080i).

Note

- If the images are not displayed properly using the [Auto] setting, select either [1080i], [1080p] or [2160p/1080p], based on which TV is to be connected.

24p/60p Output (Only for 1080 60i compatible models)

You can set 1080/24p or 1080/60p as the HDMI output format when  [Record Setting] is set to [24p 50M], [24p 60M] or [24p 100M].

- ① **MENU** →  (Setup) → [HDMI Settings] → [HDMI Resolution] → [1080p] or [2160p/1080p].
- ② **MENU** →  (Setup) → [HDMI Settings] →  [24p/60p Output] → desired setting.

60p: Movies are output as 60p.

24p: Movies are output as 24p.

Note

- Steps ① and ② can be set in either order.

HDMI Info. Display

Selects whether to display the shooting information when this product and the TV are connected using an HDMI cable (sold separately).

MENU →  (Setup) → [HDMI Settings] → [HDMI Info. Display] → desired setting.

On: Displays the shooting information on the TV.

The recorded image and the shooting information are displayed on the TV, while nothing is displayed on the camera's monitor.

Off: Does not display the shooting information on the TV.

Only the recorded image is displayed on the TV, while the recorded image and the shooting information are displayed on the camera's monitor.

Note

- When the camera is connected to an HDMI device while  [File Format] is set to [XAVC S 4K], the setting switches to [Off].

TC Output

Sets whether or not to layer the TC (time code) information on the output signal via the HDMI terminal when outputting the signal to other professional-use devices.



This function layers the time code information on the HDMI output signal. The product sends the time code information as digital data, not as an image displayed on the screen. The connected device can then refer to the digital data to recognize the time data.

MENU →  (Setup) → [HDMI Settings] → [ TC Output] → **desired setting.**

On: Time code is output to other devices.

Off: Time code is not output to other devices.

Note

- When [ TC Output] is set to [On], the image may not be output properly to the TV or recording device. In such cases, set [ TC Output] to [Off].

REC Control

If you connect the camera to an external recorder/player, you can remotely command the recorder/player to start/stop recording using the camera.







MENU →  (Setup) → [HDMI Settings] → [ REC Control] → **desired setting.**

On:  **STBY** The camera can send a recording command to an external recorder/player.

 **REC** The camera is sending a recording command to an external recorder/player.

Off: The camera is not able to send a command to an external recorder/player to start/stop recording.

Note

- Available for external recorders/players compatible with  REC Control].
- When you use the  REC Control] function, set the shooting mode to  (Movie).
- When  TC Output] is set to [Off], you cannot use the  REC Control] function.
- Even when  REC is displayed, the external recorder/player may not work properly depending on the settings or status of the recorder/player. Check if the external recorder/player works properly before use.

CTRL FOR HDMI

When connecting this product to a “BRAVIA” Sync-compatible TV using an HDMI cable (sold separately), you can operate this product by aiming the TV remote control at the TV.

- ① **MENU** →  (Setup) → [HDMI Settings] → [CTRL FOR HDMI] → **desired setting.**

On: You can operate this product with a TV’s remote control.

Off: You cannot operate this product with a TV’s remote control.

- ② **Connect this product to a “BRAVIA” Sync-compatible TV.**
The input of the TV is switched automatically and images on this product are displayed on the TV screen.
- ③ **Press the SYNC MENU button of the TV’s remote control.**
- ④ **Operate this product using the TV’s remote control.**

Note

- If you connect this product to a TV using an HDMI cable, available menu items are limited.
- [CTRL FOR HDMI] is available only with a “BRAVIA” Sync-compatible TV. Also, the SYNC MENU operation differs depending on the TV you are using. For details, refer to the operating instructions supplied with the TV.
- If the product performs unwanted operations in response to the TV remote control when the product is connected to another manufacturer’s TV using an HDMI connection, select MENU →  (Setup) → [HDMI Settings] → [CTRL FOR HDMI] → [Off].

USB Power Supply

Sets whether to supply power via the USB cable when the product is connected to a computer or an USB device.

MENU →  (**Setup**) → [**USB Power Supply**] → **desired setting**.

On: Power is supplied to the product via a USB cable when the product is connected to a computer, etc.

Off: Power is not supplied to the product via a USB cable when the product is connected to a computer, etc.

Operations available while supplying power via a USB cable

The following table shows you which operations are available/unavailable while supplying power via a USB cable.

A checkmark indicates that the operation is available, and “—” indicates that the operation is unavailable.

Operation	Available/Unavailable
Shooting images	✓
Playing back images	✓
Wi-Fi/NFC/Bluetooth connections	✓
Charging a battery pack	—
Turning the camera on without a battery pack inserted	—

Note

- Insert the battery pack into the product to supply power via USB cable.

Save/Load Settings

You can save/load camera settings to/from a memory card. You can also load settings from another camera of the same model.

MENU →  (**Setup**) → [**Save/Load Settings**] → **desired item**.

Save: Saves the current settings of this camera to a memory card.

Load: Loads the settings from a memory card to this camera.

Delete: Deletes the settings saved on a memory card.

Hint

- For details on which settings can be saved, refer to the “Help Guide.”

Note

- You can save up to 10 settings per memory card. When 10 settings have been already saved, you cannot perform [Save New]. Delete the existing settings using [Delete], or overwrite them.
- Only Slot 1 is used for saving or loading data. You cannot change the saving/loading destination slot.
- You cannot load settings from a camera of a different model.

Initializing the camera

Setting Reset

Resets the product to the default settings. Even if you perform [Setting Reset], the recorded images are retained.

MENU →  (**Setup**) → [**Setting Reset**] → **desired setting**.

Camera Settings Reset: Initializes the main shooting settings to the default settings.

Initialize: Initializes all the settings to the default settings.

Note

- Be sure not to eject the battery pack while resetting.
- The value set with [AF Micro Adj.] will not be reset even when [Camera Settings Reset] or [Initialize] is performed.

Using the Wi-Fi/One-touch (NFC)/Bluetooth/wired LAN functions

You can perform the following operations using the camera's Wi-Fi, NFC One-touch, Bluetooth, and wired LAN functions.

- Saving images to a computer
- Transferring images from the camera to a smartphone
- Using a smartphone as a remote control for the camera
- Viewing still images on a TV
- Recording location information from a smartphone to images
- Transferring images to the FTP server

For details, refer to the "Help Guide" (page 2).

Installing Imaging Edge Mobile

Imaging Edge Mobile is required to connect the camera and a smartphone. If Imaging Edge Mobile is already installed on your smartphone, be sure to update it to the latest version.

For details on Imaging Edge Mobile, refer to the support page (<https://www.sony.net/iem/>).



Note

- To use the camera's NFC One-touch function, an NFC-enabled smartphone or tablet is required.
- The Wi-Fi functions introduced in this manual are not guaranteed to operate on all smartphones or tablets.
- Depending on future version upgrades, the operational procedures or screen displays are subject to change without notice.

Recording location information to captured images

By using Imaging Edge Mobile, you can obtain location information from a connected smartphone (via Bluetooth communication) and record it to captured images.

For details on the operating procedure, refer to the “Help Guide” (page 2) or the following support page.



<https://www.sony.net/iem/btg/>

Transferring images to the FTP server

You can use the camera's Wi-Fi function or wired LAN to transfer images to the FTP server.

For details, refer to the “FTP Help Guide.”

https://rd1.sony.net/help/di/ftp/h_zz/



- Basic knowledge of FTP servers is required.

Connecting the camera and a smartphone

Using a smartphone as a remote control for the camera

With Imaging Edge Mobile, you can shoot images while checking the shooting range of the camera on the monitor of a smartphone.

1 MENU →  (Network) → [Ctrl w/ Smartphone] → [Ctrl w/ Smartphone], then select [On].

2 Set up the camera and smartphone by following the procedure below.



To establish a one-touch connection with an NFC-enabled smartphone

① Activate the NFC function of the smartphone.

- On an iPhone/iPad, launch Imaging Edge Mobile, and then select [Scan NFC/QR Code of the Camera] → [Scan NFC of the Camera] to activate the NFC function.

② Switch the camera to the shooting mode.



③ Touch the  (N-Mark) on the camera to the smartphone for 1-2 seconds.

- If you are using an Android smartphone, touch the  (N-Mark) on the camera to the  (N-Mark) on the smartphone.

Note

- If you cannot connect the camera to the smartphone using the NFC function, follow the procedure under “To establish a Wi-Fi connection with a smartphone using a QR code.”

To establish a Wi-Fi connection with a smartphone using a QR code

- 1 Select MENU →  (Network) → [Ctrl w/ Smartphone] →  Connection], to display the QR code on the monitor of the camera.



- 2 Launch Imaging Edge Mobile on the smartphone, and select [Scan QR Code of the Camera].
- 3 Scan the QR code.

Hint

- Once the QR code has been read, this product's SSID (DIRECT-xxxx) and password are registered to the smartphone. This enables you to easily connect the smartphone to the product via Wi-Fi at a later date by selecting the SSID.

Note

- If you cannot connect this product to a smartphone using the NFC function or QR code, use the SSID and password. For detailed instructions, refer to the "Help Guide."





Transferring images from the camera to a smartphone

You can transfer still images and XAVC S movies to a smartphone. However, images that are not saved on the camera's memory card cannot be transferred.

1 On the camera, play back an image that you want to transfer to the smartphone.

2 Connect the camera to the smartphone.



Images shot with the camera are transferred to the smartphone.

- To establish a one-touch connection with an NFC-enabled smartphone, touch the smartphone to the  (N-Mark) on the camera (page 205). If you are using an Android smartphone, touch the  (N-Mark) on the camera to the  (N-Mark) on the smartphone.
- To establish a Wi-Fi connection with the smartphone using a QR code, select MENU →  (Network) → [Send to Smartphone Func.] → [Send to Smartphone] and display the QR code on the monitor of the camera, then scan the QR code using Imaging Edge Mobile on the smartphone.
- The transferred images are saved to a gallery or album on the Android, or to an album on the iPhone or iPad.

Hint

- You can select images and transfer them to the smartphone while the camera is turned off by setting MENU →  (Network) → [Send to Smartphone Func.] → [Cnct. during Power OFF] to [On].

Note

- If you scan the QR code displayed under MENU →  (Network) → [Ctrl w/ Smartphone] →  [Connection], the function for using the smartphone as a remote control for the camera will be activated (page 206). To transfer images, select [Send to Smartphone] and display the QR code.
- For details on which file formats of still images and movies are transferable, refer to the "Help Guide" (page 2).

Connecting the camera to a wireless access point

Connect the camera to your wireless access point. Before starting the procedure, make sure you have the SSID (name of the access point) and password of your wireless access point with you.

1 MENU →  (Network) → [Wi-Fi Settings] → [Access Point Set.].

2 Use the control wheel to select the access point to which you want to connect. Press the center of the control wheel and enter the password for the wireless access point, then select [OK].

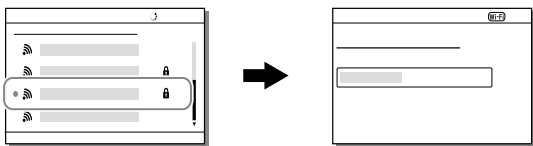

Note

- If a connection is not established, see the wireless access point operating instructions or contact the administrator of the access point.
To save images to a computer, install PlayMemories Home on your computer.

PlayMemories Home

<https://www.sony.net/pm/>

Using a remote commander with Bluetooth communication

You can operate the camera using a Bluetooth remote commander RMT-P1BT (sold separately). Select MENU →  (Network) → [Bluetooth Settings] → [Bluetooth Function] → [On] in advance. Refer to the instruction manual for the Bluetooth remote commander as well.

1 On the camera, select MENU → (Network) → [Bluetooth Rmt Ctrl] → [On].

- If there is no Bluetooth device currently paired with the camera, the screen for pairing as described in Step 2 will appear.

On: Enables Bluetooth remote commander operation.

Off: Disables Bluetooth remote commander operation.

2 On the camera, select MENU → (Network) → [Bluetooth Settings] → [Pairing] to display the screen for pairing.

3 On the Bluetooth remote commander, perform pairing.

- For details, refer to the instruction manual for the Bluetooth remote commander.
-

4 On the camera, select [OK] on the confirmation screen for the Bluetooth connection.

- Pairing is complete, and you can now operate the camera from the Bluetooth remote commander. After pairing the device once, you can connect the camera and the Bluetooth remote commander again in the future by setting [Bluetooth Rmt Ctrl] to [On].
-

Hint

- The Bluetooth connection is only active while you are operating the camera using the Bluetooth remote commander.
- If the function does not work properly, check the following notes and then try pairing again.
 - Confirm that the camera is not connected with other devices using the Bluetooth function.
 - Confirm that [Airplane Mode] for the camera is set to [Off] (page 226).
 - Execute [Reset Network Set.] of the camera.

Note

- When you initialize the camera, the pairing information is also deleted. To use the Bluetooth remote commander, perform pairing again.
- If the Bluetooth connection is unstable, remove any obstacles, such as people or metal objects from between the camera and the paired Bluetooth remote commander.
- You cannot use the function for linking location information with a smartphone while [Bluetooth Rmt Ctrl] is set to [On].
- You cannot use an infrared remote commander while [Bluetooth Rmt Ctrl] is set to [On].
- While [Bluetooth Rmt Ctrl] is set to [On], the camera will not switch to the power-saving mode. Change the setting to [Off] when you are done using the Bluetooth remote commander.

Connecting the camera to a computer

Selecting the appropriate USB connection method

Selects the USB connection method when this product is connected to a computer, etc. Select MENU →  (Network) → [Ctrl w/ Smartphone] → [Ctrl w/ Smartphone] → [Off] beforehand.

Also, when you set MENU →  (Network) → [PC Remote Function] → [PC Remote Cnct Method] to [USB], set [PC Remote] under [PC Remote Function] to [Off].

MENU →  (Setup) → [USB Connection] → **desired setting.**

Auto: Establishes a Mass Storage or MTP connection automatically, depending on the computer or other USB devices to be connected. Windows 7, Windows 8.1, or Windows 10 computers are connected in MTP, and their unique functions are enabled for use.

Mass Storage: Establishes a Mass Storage connection between this product, a computer, and other USB devices.

MTP: Establishes an MTP connection between this product, a computer, and other USB devices. Windows 7, Windows 8.1, or Windows 10 computers are connected in MTP, and their unique functions are enabled for use.

- The memory card in memory card slot 1 is the connection target.

Note

- It may take some time to make the connection between this product and a computer when [USB Connection] is set to [Auto].

Operating the camera from a computer (PC Remote Function)

Uses a Wi-Fi or USB connection, etc. to control the camera from a computer, including such functions as shooting and storing images on the computer.

The Imaging Edge (Remote) software is required for this function. For details on how to operate the camera from a computer, refer to the "Help Guide."

Introduction to computer software

We offer the following computer software to enhance your enjoyment of photos/movies. Access one of the following URLs using your Internet browser and then download the software by following the onscreen instructions.

If one of these software is already installed on your computer, update it to the latest version before use.

For details on the software for computers, refer to the following URL:

<https://www.sony.net/disoft/>

You can check the recommended operating environment for the software from the following URL:

<https://www.sony.net/pcenv/>

Imaging Edge

Imaging Edge is a software suite that includes functions such as remote shooting from a computer, and adjusting or developing RAW images recorded with the camera.

For details on Imaging Edge, refer to the following URL:

<https://www.sony.net/iex/>

PlayMemories Home

PlayMemories Home allows you to import still images and movies to your computer and view or use them.

You need to install PlayMemories Home to import XAVC S movies or AVCHD movies to your computer.

You can access the download website directly from the following URL:

<https://www.sony.net/pm/>

- When you connect the camera to your computer, new functions may be added to PlayMemories Home. Connecting the camera to your computer is therefore recommended even if PlayMemories Home has already been installed on the computer.

Remote Camera Tool

Remote Camera Tool is software for PC remote shooting using a wired LAN. You can change the camera settings and shoot images from a computer by connecting the camera to a computer or switching hub using a LAN cable.

For details on Remote Camera Tool, refer to the following URL:

<https://support.d-imaging.sony.co.jp/app/remotecameratool/l/index.php>

Using MENU items

You can change settings related to all the camera operations including shooting, playback, and operating method. You can also execute camera functions from the MENU.

1 Press the MENU button to display the menu screen.

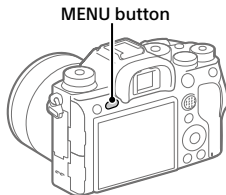



2 Select the desired setting you want to adjust using the top/bottom/left/right sides of the control wheel or by turning the control wheel, and then press the center of the control wheel.



- Select a MENU tab at the top of the screen, and press the left/right side of the control wheel to move to another MENU tab.
- You can move to another MENU tab by turning the front dial.
- You can move to the next MENU tab by pressing the Fn button.
- You can go back to the previous screen by pressing the MENU button.

3 Select the desired setting value, and press the center to confirm your selection.

Hint









- You can display the menu screen by assigning the [MENU] function to a custom key using [ Custom Key] or [ Custom Key], and then pressing that key.









List of MENU items









For details on each MENU items, refer to the reference page in the last column or the Help Guide.

1 (Camera Settings 1)

Red tab





Quality/Image Size		
 File Format	Sets the file format for still images. ([RAW] / [JPEG], etc.)	97
 RAW File Type	Selects the file type for RAW images.	98
 JPEG Quality	Selects the JPEG image quality for [RAW & JPEG] or [JPEG] under  File Format].	98
 JPEG Image Size	Selects the size of still images. (L / M / S)	99
 Aspect Ratio	Selects the aspect ratio for still images.	100
APS-C/Super 35mm	Sets whether to record in APS-C-equivalent size for still images and Super 35 mm-equivalent size for movies.	100
 Long Exposure NR	Sets noise reduction processing for shots with a shutter speed of 1 second or longer.	136
 High ISO NR	Sets noise reduction processing for high-sensitivity shooting.	137
 Color Space	Changes the color space (range of reproducible colors).	133
Lens Comp.	Selects the type of lens compensation.	Help Guide











Shoot Mode/Drive		
Self-timer Type	When shooting with the self-timer, sets how many seconds elapse from when you press the shutter button until when the image is recorded and how many images are recorded.	Help Guide
Bracket Settings	Sets self-timer shooting in the bracket mode, bracket type, and the shooting order for exposure bracketing or white balance bracketing.	89
 Interval Shoot Func.	Configures settings for interval shooting.	90
MR   1/  2 Recall	Calls up settings pre-registered to [MR  1/  2 Memory].	108
MR   1/  2 Memory	Registers the desired modes and camera settings.	176
MR Select Media	Selects the memory card slot from which settings are recalled or to which settings are registered for M1 through M4.	Help Guide
Reg. Custom Shoot Set	Assign functions to the custom key to recall when shooting.	177
AF		
Priority Set in AF-S	Sets the timing of the shutter release when [Focus Mode] is set to [Single-shot AF] or [DMF] with a still subject.	Help Guide
Priority Set in AF-C	Sets the timing of the shutter release when [Focus Mode] is set to [Continuous AF] with a moving subject.	Help Guide
Focus Area	Selects the area of focus. ([Wide] / [Flexible Spot], etc.)	49
Focus Settings	Configures settings for focusing using the front dial, rear dial or control wheel.	Help Guide
Focus Area Limit	Limits the types of available focus area settings in advance.	52



 Switch V/H AF Area	Sets whether to adjust the [Focus Area] and the position of the focusing frame based on the camera's position (horizontal or vertical).	54
 AF Illuminator	Sets the AF illuminator, which provides light to aid focusing in dark scenes.	63
Face/Eye AF Set.	Configures settings such as whether the camera focuses with priority on human faces or eyes.	56
 AF Tracking Sens.	Sets the AF tracking sensitivity for the still image mode.	Help Guide
Aperture Drive in AF	Changes the aperture drive system to prioritize the auto-focusing tracking performance or to prioritize silence.	66
 AF w/ shutter	Sets whether to perform auto focusing when the shutter button is pressed halfway down. This is useful when you want to adjust the focus and exposure separately.	Help Guide
 Pre-AF	Sets whether or not to perform auto focus before the shutter button is half pressed.	Help Guide
 Eye-Start AF	Sets whether to use auto focus when you look through the viewfinder if an LA-EA2/LA-EA4 Mount Adaptor (sold separately) is attached.	Help Guide
 AF Area Registration	Sets whether to move the focusing frame to a preassigned position when shooting still images.	61
 Del. Regist. AF Area	Deletes the focusing frame position information that was registered using [ AF Area Registration].	Help Guide
Focus Frame Color	Sets the color of the frame indicating the focusing area.	63
AF Area Auto Clear	Sets whether the focus area is displayed all the time or disappears automatically shortly after focusing.	Help Guide

Disp. cont. AF area	Sets whether or not to display the focus area in [Continuous AF] mode.	Help Guide
Phase Detect. Area	Sets phase detection AF area.	Help Guide
Circ. of Focus Point	Sets whether to allow the focusing frame to jump from one end to the other when you move the focusing frame.	64
AF Micro Adj.	Finely adjusts the autofocused position, when using the LA-EA2 or LA-EA4 Mount Adaptor (sold separately).	64
Exposure		
Exposure Comp.	Compensates for the brightness of the entire image.	111
Reset EV Comp.	Sets whether to maintain the exposure value set using [Exposure Comp.] when you turn off the power when the exposure compensation dial position is set to "0."	Help Guide
ISO Setting	Sets functions related to ISO sensitivity. ([ISO] / [ISO AUTO Min. SS], etc.)	120
Metering Mode	Selects the method for measuring brightness. ([Multi] / [Spot], etc.)	113
Face Priority in Multi Metering	Sets whether the camera measures brightness based on detected faces when [Metering Mode] is set to [Multi].	114
Spot Metering Point	Sets whether to coordinate the spot metering point with the focus area when [Focus Area] is set to [Flexible Spot], etc.	115
Exposure step	Selects the size of the increment step for shutter speed, aperture, and exposure compensation values.	Help Guide



 AEL w/ shutter	Sets whether to lock the exposure when the shutter button is pressed halfway down. This is useful when you want to adjust the focus and exposure separately.	Help Guide
Exposure Std. Adjust	Adjusts the standard for the correct exposure value for each metering modes.	Help Guide
Flash		
Flash Mode	Sets the flash settings.	139
Flash Comp.	Adjusts the intensity of flash output.	140
Exp.comp.set	Sets whether to reflect exposure compensation value to flash compensation.	Help Guide
Wireless Flash	Sets whether to shoot with the wireless flash.	142
Red Eye Reduction	Reduces the red-eye phenomenon when using flash.	Help Guide
Color/WB/Img. Processing		
White Balance	Corrects the tone effect of the ambient light to shoot whitish objects in a white tone. ([Auto] / [Daylight], etc.)	126
Priority Set in AWB	Selects which tone to prioritize when shooting under lighting conditions such as incandescent light with [White Balance] set to [Auto].	Help Guide
DRO/Auto HDR	Analyzes the contrast of light and shadow between the subject and the background by dividing the image into small areas, and creates an image with the optimal brightness and gradation.	117
Creative Style	Selects the desired image processing. You can also adjust contrast, saturation, and sharpness. ([Vivid] / [Portrait], etc.)	130

Picture Effect	Shoots images with a texture unique to the selected effect. ([Toy Camera] / [High Contrast Mono.], etc.)	Help Guide
 Shutter AWB Lock	Sets whether to lock the white balance while the shutter button is pressed in the auto white balance mode.	128
Focus Assist		
Focus Magnifier	Enlarges the image before shooting so that you can check the focus.	69
Focus Magnif. Time	Sets the length of time the image will be shown in an enlarged form.	Help Guide
 Initial Focus Mag.	Sets the initial magnification scale when using [Focus Magnifier].	Help Guide
 AF in Focus Mag.	Sets whether or not to autofocus when an enlarged image is being displayed. While the enlarged image is being displayed, you can focus within a smaller area than the flexible spot.	Help Guide
 MF Assist	Displays an enlarged image when focusing manually.	70
Peaking Setting	Sets the peaking function, which enhances the outline of in-focus areas when focusing manually.	Help Guide
Shooting Assist		
 Anti-flicker Shoot.	Detects flickering/blinking from artificial light sources such as fluorescent lighting and times the shooting of images to moments when flickering will have less of an impact.	76
Face Registration	Registers or changes the person to be given priority when focusing.	Help Guide
Regist. Faces Priority	Detects the registered face with higher priority using [Face Registration].	Help Guide

Movie		
 Exposure Mode	Sets the exposure mode when shooting movies.	109
 S&Q Exposure Mode	Sets the exposure mode when shooting slow-motion/quick-motion movies.	110
 File Format	Selects the movie file format. ([XAVC S 4K] / [AVCHD], etc.)	149
 Record Setting	Selects a frame-rate and bit-rate for the movie.	150
 S&Q S&Q Settings	Changes the settings for slow-motion and quick-motion movie shooting.	152
 Proxy Recording	Records low-bit-rate proxy files simultaneously when recording XAVC S movies.	158
 AF drive speed	Switches focusing speed when using autofocus in movie mode.	Help Guide
 AF Tracking Sens.	Sets the AF tracking sensitivity for the movie mode.	Help Guide
 Auto Slow Shutter	Sets the function that automatically adjusts the shutter speed following the brightness of the environment in movie mode.	Help Guide
 Initial Focus Mag.	Sets the initial magnification scale when using [Focus Magnifier] in movie mode.	Help Guide
Audio Recording	Sets whether to record audio when shooting a movie.	154
Audio Rec Level	Adjusts the audio recording level during movie recording.	155
Audio Level Display	Sets whether to display the audio level.	Help Guide
Audio Out Timing	Sets the timing of audio output during the movie recording.	Help Guide

Wind Noise Reduct.	Reduces wind noise during movie recording.	Help Guide
 Marker Display	Sets whether to display markers on the monitor when recording movies.	156
 Marker Settings	Sets which markers to display on the monitor when recording movies.	156
Video Light Mode	Sets the illumination setting for the HVL-LBPC LED light (sold separately).	Help Guide
Movie w/ shutter	Records movies using the shutter button.	147
Shutter/SteadyShot		
 Shutter Type	Sets whether to shoot with a mechanical shutter or an electronic shutter.	71
e-Front Curtain Shutter	Sets whether to use the electronic front curtain shutter function.	78
Release w/o Lens	Sets whether to release the shutter when the lens is not attached.	Help Guide
Release w/o Card	Sets whether to release the shutter when a memory card is not inserted.	Help Guide
SteadyShot	Sets whether to activate SteadyShot for shooting.	134
SteadyShot Settings	Sets SteadyShot settings.	134
Zoom		
Zoom	Sets the zoom scale for zoom functions other than the optical zoom.	124
Zoom Setting	Sets whether to use the Clear Image Zoom and Digital Zoom when zooming.	124
Zoom Ring Rotate	Assigns the zoom in/out to the rotational direction of the zoom lens. This function is only available with a power zoom lens that is compatible with this function.	Help Guide

Display/Auto Review		
DISP Button	Sets the type of information to be displayed on the monitor or in the viewfinder when the DISP button is pressed.	33
FINDER/MONITOR	Sets the method for switching the display between the viewfinder and the monitor.	187
 Finder Frame Rate	Sets the frame rate for the viewfinder when shooting still images.	188
Zebra Setting	Sets the stripes displayed to adjust brightness.	Help Guide
Grid Line	Displays grid lines for adjusting the image composition.	Help Guide
Exposure Set. Guide	Sets the guide displayed when exposure settings are changed in the shooting screen.	Help Guide
Live View Display	Sets whether to reflect settings such as exposure compensation in screen display.	Help Guide
Shoot. Start Disp.	Sets whether or not to signal the shutter release timing with a black screen when the first image is shot during blackout-free shooting.	76
Shoot. Timing Disp.	Sets whether or not to display indicators (such as a frame) on the screen to show if the camera is shooting.	75
Cont. Shoot. Length	Sets whether to display an indicator of the remaining time for which continuous shooting can be performed at the same shooting speed.	81
Auto Review	Sets auto review to display the captured image after shooting.	185

Custom Operation		
 Custom Key	Assigns functions to the various keys so that you can perform operations more quickly by pressing the keys when shooting still images.	179
 Custom Key	Assigns functions to the various keys so that you can perform operations more quickly by pressing the keys when shooting movies.	179
 Custom Key	Assigns functions to the keys so that you can perform operations more quickly by pressing the keys when playing back images.	179
Function Menu Set.	Customizes the functions displayed when the Fn (Function) button is pressed.	28
My Dial Settings	Assigns the desired functions to the dials and the control wheel, and register up to three combinations of settings.	181
Dial Setup	Sets the functions of the front and rear dials when the exposure mode is set to M. Dials can be used for adjusting shutter speed and aperture value.	Help Guide
Av/Tv Rotate	Sets the direction of turning the front or rear dial or the control wheel to adjust the aperture value or shutter speed.	Help Guide
Dial Ev Comp	Sets whether to compensate the exposure with the front or rear dial.	Help Guide
Function Ring (Lens)	Assigns a function to the function ring on the lens.	Help Guide
Func. of Touch Operation	Sets which function is activated by touch operations on the monitor.	94, 95
MOVIE Button	Enables or disables the MOVIE button.	Help Guide

Lock Operation Parts	Sets whether to disable the multi-selector, control wheel, or front and rear dials temporarily when the Fn button is pressed and held down.	Help Guide
Audio signals	Selects whether the electronic shutter makes a sound or the camera beeps during auto focus and self-timer operations.	Help Guide

(Network)

Green tab

Send to Smartphone Func.	Sets movies to be transferred to a smartphone, or transfers images to a smartphone.	Help Guide
Send to Computer (Wi-Fi)	Backs up images by transferring them to a computer connected to a network.	Help Guide
FTP Transfer Func.	Sets image transfer using FTP and executes it. * Basic knowledge of FTP server is required.	204
View on TV	Allows you to view images on a network-enabled TV.	Help Guide
Ctrl w/ Smartphone	Sets the condition for connecting the camera to a smartphone.	Help Guide
PC Remote Function	Configures settings for PC remote shooting.	Help Guide
Airplane Mode	Disables wireless communications from the device such as Wi-Fi, NFC, and Bluetooth function.	Help Guide
Wi-Fi Settings	Allows you to register your access point and check or change the Wi-Fi connection information.	Help Guide

Bluetooth Settings	Configures settings for connecting the camera to a smartphone or a Bluetooth remote commander via a Bluetooth connection.	209, Help Guide
 Location Info. Link Set.	Obtains location information from the paired smartphone and records it to captured images.	Help Guide
Bluetooth Rmt Ctrl	Sets whether or not to use a Bluetooth remote commander.	209
Wired LAN Setting	Sets the wired LAN.	Help Guide
Edit Device Name	Changes the device name under Wi-Fi Direct, etc.	Help Guide
Import Root Certificate	Imports a root certificate to the camera.	Help Guide
Security (IPsec)	Sets whether or not to encrypt communications between the camera and a computer while they are connected via Wi-Fi or a wired LAN.	Help Guide
Reset Network Set.	Resets all the network settings.	Help Guide

 (Playback)

Blue tab

Protect	Protects recorded images against accidental erasure.	168
Rotate	Rotates the image.	Help Guide
Delete	Deletes images.	174
Rating	Assigns rating to recorded images on a scale from ★ to ★★.	170
Rating Set (Custom Key)	Sets the rating (number of ★) that can be selected using the custom key to which [Rating] has been assigned with [ Custom Key].	171









Specify Printing	Specifies in advance on the memory card which still images to print out later.	Help Guide
Voice Memo	Records, plays back, and deletes voice memos.	172
Voice Memo PB Volume	Sets the playback volume for voice memos.	Help Guide
Copy	Copies images from the memory card in the memory card slot designated in [Select Playback Media] to the memory card in the other slot.	166
Photo Capture	Captures a chosen scene in a movie to save as a still image.	162
 Enlarge Image	Enlarges the playback images.	160
 Enlarge Initial Mag.	Sets the initial magnification scale when playing back enlarged images.	Help Guide
 Enlarge Initial Position	Sets the initial magnification area when playing back enlarged images.	Help Guide
Cont. PB for  Interval	Continuously plays back images shot using interval shooting.	165
PB Speed for  Interval	Sets the playback speed when continuously playing back images with [Cont. PB for  Interval].	Help Guide
Slide Show	Plays a slide show.	167
Select Playback Media	Selects the memory card slot of the memory card to be played back.	166
View Mode	Plays back images from a specified date or specified folder of still images and movies.	165
Image Index	Displays multiple images at the same time.	163
Display as Group	Sets whether or not to display images shot continuously or shot using interval shooting as a group.	Help Guide
Display Rotation	Sets the playback orientation for images shot vertically.	161



Image Jump Setting	Sets which dial and method to use for jumping between images during playback.	164
---------------------------	---	-----

(Setup)

Yellow tab

Monitor Brightness	Adjusts the brightness of the screen.	Help Guide
Viewfinder Bright.	Sets the brightness of the viewfinder.	Help Guide
Finder Color Temp.	Sets the color temperature of the viewfinder.	Help Guide
Volume Settings	Sets the volume for movie playback.	Help Guide
Delete confirm.	Sets whether [Delete] or [Cancel] is preselected in the delete confirmation screen.	Help Guide
Power Save Start Time	Sets the time intervals to automatically switch to power save mode.	195
Auto Power OFF Temp.	Sets the camera temperature at which the camera turns off automatically during shooting. When shooting in hand-held mode, set to [Standard].	Help Guide
NTSC/PAL Selector*1	Changes the TV format of the device so that you can shoot in a different movie format.	Help Guide
Cleaning Mode	Starts the cleaning mode to clean the image sensor.	240
Touch Operation	Sets whether or not to activate the touch operation of the monitor.	93
Touch Panel/Pad	Selects whether to activate touch panel operation when shooting with the monitor, or touch pad operation when shooting with the viewfinder.	93

Touch Pad Settings	Adjusts settings related to touch pad operation.	Help Guide
Demo Mode	Sets demonstration playback of movies to on or off.	Help Guide
TC/UB Settings	Sets the time code (TC) and user bit (UB). * This function is for skilled movie creators.	Help Guide
IR Remote Ctrl	Sets whether to use the infrared remote control.	195
HDMI Settings	Sets the HDMI settings.	196
 4K Output Select	Sets how to record and output 4K movies via HDMI when the camera is connected to an external recorder/ player that supports 4K.	157
USB Connection	Sets the USB connection method.	211
USB LUN Setting	Enhances compatibility by limiting the functions of USB connection. Set to [Multi] in normal conditions and to [Single] only when the connection cannot be established.	Help Guide
USB Power Supply	Sets whether to supply power via USB connection when the camera is connected to a computer or USB device.	200
 Language	Selects the language.	42
Date/Time Setup	Sets the date, time, and daylight savings.	42
Area Setting	Sets the location of use.	Help Guide
IPTC Information	Writes IPTC information when recording still images.	Help Guide
Copyright Info	Sets copyright information for still images.	Help Guide
Write Serial Number	Writes the camera's serial number to the Exif data when recording still images.	Help Guide

Format	Formats the memory card.	189
Rec. Media Settings	Sets the method for recording images to two memory card slots.	192, Help Guide
 File/Folder Settings	Sets file names for still images to be shot, and specifies folders for storing the shot still images.	189
 File Settings	Sets file numbers and file names for movies to be recorded.	191
Recover Image DB	Recovers the image database file and enables recording and playback.	Help Guide
Display Media Info.	Displays the remaining recording time of movies and the recordable number of still images on the memory card.	Help Guide
Version	Displays the camera software version.	Help Guide
Save/Load Settings	Saves the camera settings to a memory card, or reads saved settings from the memory card.	201
Setting Reset	Restores settings to their defaults. Select [Initialize] to restore all settings to their default values.	202

Add Item	Adds desired MENU items to ★ (My Menu).	183
Sort Item	Sorts the MENU items added to ★ (My Menu).	183
Delete Item	Deletes MENU items added to ★ (My Menu).	184
Delete Page	Deletes all the MENU items on a page in ★ (My Menu).	Help Guide
Delete All	Deletes all the MENU items added to ★ (My Menu).	Help Guide
Display From My Menu	Sets whether or not to display the My Menu first when the MENU button is pressed.	184

*1 If you change this item, you will need to format the memory card for compatibility with the PAL or NTSC system. Also, note that it may not be possible to play back movies recorded for the NTSC system on PAL system TVs.

**24M 21M 20M 16M 10M 9.2M
8.7M 6.9M 6.0M 5.3M 5.1M
4.0M 2.6M 2.3M 2.2M 1.7M**

Image size of still images (99)

RAW

RAW recording (compressed/
uncompressed) (98)

X.FINE FINE STD

JPEG Quality (98)

XAVC S 4K XAVC S HD AVCHD

File format of movies (149)

**100 60 50 25 16
FX FH**

Record setting of movies (150)

**120p 60p 60i 30p 24p
100p 50p 50i 25p**

Frame rate of movies (150)

**100^{px} 60^{px} 50^{px} 25^{px}
16^{px}**

Proxy Recording (158)

**120fps 60fps 30fps 15fps 8fps
4fps
100fps 50fps 25fps 12fps 6fps
3fps 2fps 1fps**

Frame rate for slow/quick
motion shooting (152)



APS-C/Super 35mm (100)



Flash charge in progress (138)

VIEW

Setting Effect OFF (224)



AF Illuminator (63)

Flicker

Flickering detected (76)



SteadyShot off/on, Camera
shake warning (134)

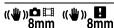

SteadyS. Focal Len./ Camera
shake warning (134)



Smart Zoom /
Clear Image Zoom / Digital
Zoom (123)



PC remote (212)



Bright Monitoring



Shooting without shutter sound
(73)



Remote control (195, 209)



No audio recording of movies
(154)



Wind Noise Reduct. (223)



Copyright information writing on (230)

IPTC

IPTC information writing on (230)



Focus Cancel (94)



Tracking Cancel (95)

Spot Focus

Performing [Spot Focus] (95)



NFC active (203)



Bluetooth connection available / Bluetooth connection unavailable (227)



Connected to smartphone / Not connected to smartphone



Obtaining location information / Location information cannot be obtained (227)



Airplane Mode (226)



Overheating warning



Database file full/Database file error

3 Battery



Remaining battery (35)



Remaining battery warning



USB power supply (200)

4 Shooting settings

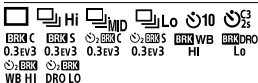

Drive Mode (79)

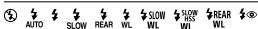

Flash Mode (139) /
Wireless Flash (142) /
Red Eye Reduction (220)



Flash Comp. (140)



Focus Mode (47)



Focus Area (49)

JPEG RAW RAW+J RAW+J

File Format (97)



Metering Mode (113)



7500K A5 G5

White Balance (Auto, Preset, Underwater Auto, Custom, Color temperature, Color filter) (126)



D-Range Optimizer (117)/
Auto HDR (118)



+3 +3 +3

Creative Style (130)/Contrast,
saturation, and sharpness



Picture Effect (221)



Face/Eye Priority in AF (56)



Shutter Type (71)



Prioritize Rec. Media (192)

5 Focus indicator/exposure settings



Focus indicator (48)

1/250

Shutter speed

F3.5

Aperture value



Exposure compensation (111)/
Metered Manual

ISO400 ISO AUTO ISO400

ISO sensitivity (120)



AE lock (116)/FEL lock (141)/
AWB lock (128)

6 Guides/other

Tracking Cancel

Guide display for tracking (95)

Focus Cancel

Guide display for canceling
focusing (94)



Control wheel function

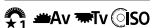

Guide display for My Dial (181)



Bracket indicator (86)



Spot metering area (113)

320 400 500
5.0 5.6 6.3

Exposure Setting Guide (224)



Shutter speed indicator (33)



Aperture indicator (33)



Histogram (32)



Digital level gauge (34)

STBY REC

Movie recording standby/Movie recording in progress

1:00:12

Actual movie recording time (hours: minutes: seconds)



Audio Level Display (222)



REC Control (198)

00:00:00:00

Time code (hours: minutes: seconds: frames) (230)

00 00 00 00

User Bit (230)

Icons on the playback screen

Single-image playback

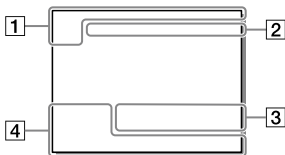

Histogram display

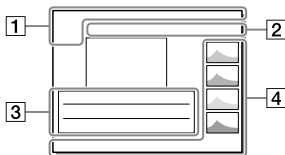

1 Basic information



Playback media (166)

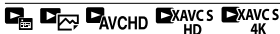

View Mode (165)

IPTC

IPTC Information (230)



Rating (170)



Protect (168)

DPOF

DPOF set (228)

3/7

File number/Number of images
in the view mode



NFC active (203)



Remaining battery (35)



Display as Group (228)



Proxy movie included (158)



A voice memo is attached (172)

2 Camera settings

Refer to “Icons on the shooting
screen” (page 233).

3 Shooting settings



Picture Effect error



Auto HDR error (118)

35mm

Lens focal length

Refer to “Icons on the shooting
screen” (page 233) for other icons
displayed in this area.

4 Image information



Latitude/longitude information
(204)



Copyright information included

2019-1-1 10:37PM

Date of recording (42)

100-0003

Folder number – File number
(189)

C0003

Movie file number (191)



Histogram (Luminance/R/G/B)
(32)

Troubleshooting

If you experience trouble with the product, try the following solutions.

❶ Refer to the "Help Guide" (page 2).

❷ Remove the battery pack, wait for about one minute, re-insert the battery pack, then turn on the power.

❸ Initialize the settings (page 202).

❹ Consult your dealer or local authorized service facility. Additional information on this product and answers to frequently asked questions can be found at our Customer Support Website.

Americas

<https://www.sony.com/am/support>

Europe

<https://www.sony.eu/support>

Asia-Pacific, Oceania, Middle East and Africa

<https://www.sony-asia.com/support>

Cleaning the image sensor

If dust or debris gets inside the camera and adheres to the surface of the image sensor (the part that converts the light to an electric signal), it may appear as dark spots on the image, depending on the shooting environment. If this happens, follow the steps below to clean the image sensor.

1 Confirm that the battery has been charged sufficiently.

2 MENU →  (Setup) → [Cleaning Mode] → [Enter].

The image sensor vibrates a little to shake off the dust.

3 Turn off the product following the instructions on the screen.

4 Detach the lens.

5 Use the blower to clean the image sensor surface and the surrounding area.

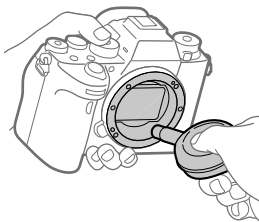

6 Attach the lens.

Hint

- For how to check the amount of dust on the image sensor, and for further details on cleaning methods, please refer to the following URL.
<https://support.d-imaging.sony.co.jp/www/support/ilc/sensor/index.php>

Note

- Clean the image sensor quickly.
- A blower is not supplied with this product. Use a commercially available blower.
- Make sure that the remaining battery level is  (3 remaining battery icons) or more, before performing the cleaning.
- Do not use a spray type blower as it may scatter water droplets inside the camera body.
- Do not put the tip of a blower into the cavity beyond the lens mount area, so that the tip of the blower does not touch the image sensor.
- Hold the camera slightly face downward so that the dust falls out.
- Do not subject the product to any shock during cleaning.
- When cleaning the image sensor with a blower, do not blow too hard. If you blow the sensor too hard, the inside of the product may be damaged.
- If the dust remains even after you cleaned the product as described, consult the service facility.

Attaching accessories

Mount Adaptor

Using a Mount Adaptor (sold separately), you can attach an A-mount lens (sold separately) to this product.

For details, refer to the operating instructions supplied with the Mount Adaptor.

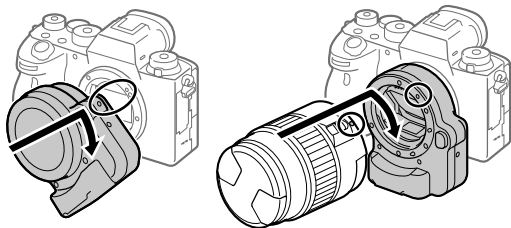

Note

- You may not be able to use the Mount Adaptor or auto-focus with certain lenses. Consult your Sony dealer or local authorized Sony service facility on compatible lenses.
- The LA-EA2 or LA-EA4 Mount Adaptor (sold separately) and the vertical grip (sold separately) are not designed to be attached at the same time. If you attach them at the same time, the space between the Mount Adaptor and the vertical grip will become narrow, making the camera difficult to hold.
- You cannot use the AF illuminator when using an A-mount lens.
- The sound of the lens and the product in operation may be recorded during movie recording. You can turn the sound off by selecting MENU →  2 (Camera Settings 2) → [Audio Recording] → [Off].
- It may take a long time or may be difficult for the product to focus, depending on the lens used or the subject.

■ LA-EA1/LA-EA3 Mount Adaptor

If you use the LA-EA1 Mount Adaptor (sold separately) or LA-EA3 Mount Adaptor (sold separately), the following functions are available.

	LA-EA1	LA-EA3
Full frame shooting	Not available	Available with full frame shooting-compatible lenses only
Autofocus	Available with SAM/SSM lens only	
AF system	Phase Detection AF	
AF/MF select	Can be changed using the operating switch on the lens.	
Focus Mode	Single-shot AF/Continuous AF • When using a Mount Adaptor in the movie mode, adjust the aperture value and the focus manually.	
Available focus area	Wide / Zone / Center / Flexible Spot / Expand Flexible Spot / Tracking	
SteadyShot	In-body	

■ LA-EA2/LA-EA4 Mount Adaptor

If you use the LA-EA2 Mount Adaptor (sold separately) or LA-EA4 Mount Adaptor (sold separately), the following functions are available.

	LA-EA2	LA-EA4
Full frame shooting	Not available	Available with full frame shooting-compatible lenses only
Autofocus	Available	
AF system	Phase Detection AF, which is controlled by the dedicated AF sensor inside the Mount Adaptor	
AF/MF select	Lenses that do not support DMF (with a focus mode switch): Can be changed using the focus mode switch on the lens. Lenses that support DMF (with a focus mode switch): Can be changed using the focus mode switch on the lens. When the focus mode switch on the lens is set to AF, you can change the focusing method by operating the camera. Other lenses (without a focus mode switch): Can be changed by operating the camera.	
Focus Mode	Single-shot AF/Continuous AF/DMF* * Only available when using lenses that support Direct Manual Focus. <ul style="list-style-type: none">• Even if [Priority Set in AF-S] is set to [Balanced Emphasis], it will temporarily switch to [AF].• Even if [Priority Set in AF-C] is set to [Balanced Emphasis], it will temporarily switch to [Release].	
Available focus area	Wide / Center / Flexible Spot / Tracking	
SteadyShot	In-body	

Continuous shooting using a Mount Adaptor

When a Mount Adaptor is attached to the camera, the auto-focusing method during continuous shooting varies depending on the settings for [Cont. Shooting] and [Shutter Type].

When using the LA-EA1 Mount Adaptor (sold separately), LA-EA2 Mount Adaptor (sold separately) or LA-EA4 Mount Adaptor (sold separately)

	Shutter Type	
	Mechanical Shutter	Auto/Electronic Shutter
Continuous Shooting: Hi	The focus is locked to the setting in the first shot.	
Continuous Shooting: Mid		
Continuous Shooting: Lo	The focus continuously tracks the subjects.	

When using the LA-EA3 Mount Adaptor (sold separately)

Update the firmware of the Mount Adaptor to the latest version in advance.

	Shutter Type	
	Mechanical Shutter	Auto/Electronic Shutter
Continuous Shooting: Hi	The focus continuously tracks the subjects.*1	The focus continuously tracks the subjects.*1*2
Continuous Shooting: Mid	The focus continuously tracks the subjects.*1	
Continuous Shooting: Lo	The focus continuously tracks the subjects.	

*1 When the F-value is greater than F16, the focus does not track the subjects. The focus is locked to the setting in the first shot.

*2 The continuous shooting speed varies depending on the [Focus Mode] setting.

– [Single-shot AF]/[DMF]/[Manual Focus]: Maximum of 20 images per second (the focus is locked to the setting in the first shot).

– [Continuous AF]: Maximum of 10 images per second

Note

- When you are using a Mount Adaptor, you cannot perform blackout-free continuous shooting in [Continuous Shooting: Lo] mode (page 73).



Vertical grip

You can attach a vertical grip (sold separately) to this product and record vertically oriented images. When attaching the vertical grip, remove the battery cover in advance.

For details, refer to the operating instructions for the vertical grip.

To remove the battery cover

For details on how to remove or attach the battery cover, refer to page 24.

- You can attach the removed battery cover to the vertical grip so that you do not lose it.
- When a vertical grip is attached to this product, the battery remaining is displayed as **1**  **2** .

Hint

- The battery pack inside the vertical grip can be charged while the vertical grip is attached to the camera.
Turn the camera off and connect it to a device such as a computer using the USB cable.
- Use the USB Type-C cable (supplied) or a USB-standard cable.

Note

- The LA-EA2/LA-EA4 Mount Adaptor (sold separately) and the vertical grip are not designed to be attached at the same time. If you attach them at the same time, the space between the Mount Adaptor and the vertical grip will become narrow, making the camera difficult to hold.

Specifications

Battery life and number of recordable images

		Battery life	Number of images
Shooting (still images)	Screen mode	—	Approx. 690
	Viewfinder mode	—	Approx. 500
Actual shooting (movies)	Screen mode	Approx. 120 min.	—
	Viewfinder mode	Approx. 110 min.	—
Continuous shooting (movies)	Screen mode	Approx. 200 min.	—
	Viewfinder mode	Approx. 195 min.	—

- The above estimates for battery life and number of recordable images apply when the battery pack has been fully charged. The battery life and number of images may decrease depending on the conditions of use.
- The battery life and number of recordable images are estimates based on shooting with the default settings under the following conditions:
 - Using the battery pack at an ambient temperature of 25°C (77°F).
 - Using a Sony SDXC memory card (U3) (sold separately)
 - Using a FE 28-70 mm F3.5-5.6 OSS lens (sold separately)
- The numbers for “Shooting (still images)” are based on the CIPA standard and shooting under the following conditions: (CIPA: Camera & Imaging Products Association)
 - One picture is taken every 30 seconds.
 - The power is turned on and off once every ten times.
- The number of minutes for movie shooting is based on the CIPA standard and shooting under the following conditions:
 - The image quality is set to XAVC S HD 60p 50M / 50p 50M.
 - Actual shooting (movies): Battery life based on repeated shooting, zooming, shooting stand-by, turning on/off, etc.
 - Continuous shooting (movies): No operations other than starting and ending shooting are performed.

Memory cards that can be used

This camera only supports SD memory cards (UHS-II compatible). When using microSD memory cards with this camera, be sure to use the appropriate adaptor.

Recording format		Supported memory card
Still image		SD/SDHC/SDXC card
AVCHD		SD/SDHC/SDXC card (Class 4 or faster, or U1 or faster)
XAVC S	4K 60 Mbps* HD 50 Mbps or lower* HD 60 Mbps	SDHC/SDXC card (Class 10, or U1 or faster)
	4K 100 Mbps* HD 100 Mbps	SDHC/SDXC card (U3)

* Including when recording proxy movies at the same time

Note

- When an SDHC memory card is used to record an XAVC S movie over extended periods of time, the recorded movies will be divided into files 4 GB in size. The divided files can be handled as a single file by importing them to a computer using PlayMemories Home.
- When recording a movie on memory cards in both the slot 1 and the slot 2 with following camera settings, insert two memory cards with the same file system. XAVC S movies cannot be recorded simultaneously when using a combination of the exFAT file system and FAT32 file system.
 - [File Format] is set to [XAVC S 4K] or [XAVC S HD]
 - [Recording Mode] under [Rec. Media Settings] is set to [Simult. (📷/📹)] or [Simult. (📷/📹)]

Memory card	File system
SDXC memory card	exFAT
SDHC memory card	FAT32

- Charge the battery pack sufficiently before attempting to recover the database files on the memory card.

Number of recordable images

When you insert a memory card into the camera and turn the camera on, the number of images that can be recorded (should you continue to shoot using the current settings) is displayed on the screen.

Note

- When “0” (the number of recordable images) flashes in orange, the memory card is full. Replace the memory card with another one, or delete images from the current memory card.
- When “NO CARD” flashes in orange, it means no memory card has been inserted. Insert a memory card.

The number of images that can be recorded on a memory card

The table below shows the approximate number of images that can be recorded on a memory card formatted with this camera. The values are defined using Sony standard memory cards for testing.

The values may vary depending on the shooting conditions and the type of memory card used.

[JPEG Image Size]: [L: 24M]

[Aspect Ratio]: [3:2]*1

(Units: Images)

JPEG Quality/ File Format	8 GB	32 GB	64 GB	256 GB
Standard	1100	4550	9000	36000
Fine	780	3150	6300	25000
Extra fine	430	1700	3500	14000
RAW & JPEG (Compressed RAW)*2	210	860	1700	6900
RAW (Compressed RAW)	295	1200	2400	9600
RAW & JPEG (Uncompressed RAW)*2	125	510	1000	4100
RAW (Uncompressed RAW)	150	610	1200	4950

*1 When [Aspect Ratio] is set to other than [3:2], you can record more images than the numbers shown in the table (except when [RAW] is selected).

*2 [JPEG Quality] when [RAW & JPEG] is selected: [Fine]

Note

- Even if the number of recordable images is higher than 9999 images, “9999” will appear.
- The numbers shown are when using a Sony memory card.

Recordable movie times

The table below shows the approximate total recording times using a memory card formatted with this camera. The values may vary depending on the shooting conditions and the type of memory card used. The recording times for when [File Format] is set to [XAVC S 4K] and [XAVC S HD] are recording times when shooting with [Proxy Recording] set to [Off].

(h (hour), min (minute))

File Format	Record Setting	8 GB	32 GB	64 GB	256 GB
XAVC S 4K	30p 100M/ 25p 100M	8 min	35 min	1 h 15 min	5 h 5 min
	30p 60M/ 25p 60M	10 min	55 min	2 h	8 h 5 min
	24p 100M*	8 min	35 min	1 h 15 min	5 h 5 min
	24p 60M*	10 min	55 min	2 h	8 h 5 min
XAVC S HD	120p 100M/ 100p 100M	8 min	35 min	1 h 15 min	5 h 5 min
	120p 60M/ 100p 60M	10 min	55 min	2 h	8 h 5 min
	60p 50M/ 50p 50M	15 min	1 h 10 min	2 h 25 min	10 h
	60p 25M/ 50p 25M	30 min	2 h 20 min	4 h 45 min	19 h 25 min
	30p 50M/ 25p 50M	15 min	1 h 10 min	2 h 25 min	10 h
	30p 16M/ 25p 16M	50 min	3 h 35 min	7 h 20 min	29 h 55 min
	24p 50M*	15 min	1 h 10 min	2 h 25 min	10 h
	AVCHD	60i 24M (FX)/ 50i 24M (FX)	40 min	2 h 55 min	6 h
	60i 17M (FH)/ 50i 17M (FH)	55 min	4 h 5 min	8 h 15 min	33 h 15 min

* Only when [NTSC/PAL Selector] is set to NTSC

- The duration of time available for movie recording varies depending on the file format/recording settings for movies, memory card, ambient temperature, Wi-Fi network environment, condition of the camera before you start recording, and condition of the charging of the battery. The maximum continuous recording time for a single movie shooting session is approximately 13 hours (a product specification limit).

Note

- The recordable time of movies varies because the camera is equipped with VBR (Variable Bit-Rate), which automatically adjusts image quality depending on the shooting scene. When you record a fast-moving subject, the image is clearer but the recordable time is shorter because more memory is required for recording. The recordable time also varies depending on the shooting conditions, the subject or the image quality/size settings.
- The times shown are recordable times using a Sony memory card.

Notes on continuous movie recording



- High-quality movie recording and high-speed continuous shooting require large amounts of power. Therefore, if you continue to shoot, the temperature inside the camera will rise, especially that of the image sensor. In such cases, the camera will turn off automatically because the surface of the camera is heated to a high temperature or the high temperature affects the quality of the images or the internal mechanism of the camera.
- The duration of time available for continuous movie recording when the camera records with the default settings after the power has been turned off for a while is as follows. The values indicate the continuous time from when the camera starts recording until the camera stops recording.

Ambient temperature	Continuous recording time for movies (HD)	Continuous recording time for movies (4K)
20°C (68°F)	Approx. 60 min.	Approx. 60 min.
30°C (86°F)	Approx. 60 min.	Approx. 60 min.
40°C (104°F)	Approx. 60 min.	Approx. 30 min.

[Auto Power OFF Temp.]: [Standard]

HD: XAVC S HD (60p 50M/50p 50M, when the camera is not connected via Wi-Fi)

4K: XAVC S 4K (24p 60M/25p 60M, when the camera is not connected via Wi-Fi)

- The duration of time available for movie recording varies with the temperature, file format/record setting for movies, Wi-Fi network environment, or condition of the camera before you start recording. If you frequently recompose or shoot images after the power is turned on, the temperature inside the camera will rise and the recording time available will be shorter.
- If the  icon appears, the temperature of the camera has risen.
- If the camera stops movie recording due to a high temperature, leave it for some time with the power turned off. Start recording after the temperature inside the camera drops fully.
- If you observe the following points, you will be able to record movies for longer periods of time.
 - Keep the camera out of direct sunlight.
 - Turn the camera off when it is not being used.
- When  File Format] is set to [AVCHD], the file size of movies is limited to approx. 2 GB. If the movie file size reaches approx. 2 GB during recording, a new movie file will be created automatically.

Specifications

Camera

[System]

Camera Type:

Interchangeable Lens Digital Camera

Lens: Sony E-mount lens

[Image sensor]

Image format: 35 mm full frame
(35.6 mm × 23.8 mm), CMOS image sensor

Effective pixel number of camera:

Approx. 24 200 000 pixels

Total pixel number of camera:

Approx. 28 300 000 pixels

[SteadyShot]

In-camera sensor shift image stabilization system

[Auto focus system]

Detection system: Phase detection system/Contrast detection system

Sensitivity Range: -3 EV to +20 EV (at ISO 100 equivalent, F2.0)

[Electronic viewfinder]

Type: 1.3 cm (0.5 type) Electronic Viewfinder

Total number of dots: 3 686 400 dots

Magnification: Approx. 0.78× with 50 mm lens at infinity, -1 m⁻¹

Eye Point: Approx. 23 mm from the eyepiece and approx. 18.5 mm from the eyepiece frame at -1 m⁻¹

Diopter Adjustment:

-4.0 m⁻¹ to +3.0 m⁻¹

[Monitor]

7.5 cm (3.0 type) TFT drive, touch panel

Total number of dots: 1 440 000 dots

[Exposure control]

Metering method: 1 200-zone evaluative metering

Metering Range: -3 EV to +20 EV (at ISO 100 equivalent with F2.0 lens)

ISO sensitivity (Recommended exposure index):

Still images: ISO 100 to ISO 51 200 (Extended ISO: Minimum ISO 50, maximum ISO 204 800)

Movies: ISO 100 to ISO 51 200 equivalent (Extended ISO:

Minimum ISO 100, maximum ISO 102 400)

[Shutter]

Type: Electronically-controlled, vertical-traverse, focal-plane type

Speed range:

Still images (when shooting with the electronic shutter):

1/32 000 second* to 30 seconds (up to 1/8 second in continuous shooting)

* Available only in the M (Manual Exposure) and S (Shutter Priority) modes. For details, refer to the "Help Guide."

Still images (when shooting with the mechanical shutter):

1/8 000 second to 30 seconds, BULB

Movies: 1/8 000 second to 1/4 second

1080 60i-compatible devices (1080 50i-compatible devices): up to 1/60 (1/50) second in AUTO mode (up to 1/30 (1/25) second in Auto slow shutter mode)

Flash sync speed: 1/250 second (when using a flash manufactured by Sony)

[Recording format]

File format: JPEG (DCF Ver. 2.0, Exif Ver. 2.31, MPF Baseline) compliant, RAW (Sony ARW 2.3 format)

Movie (XAVC S format):
MPEG-4 AVC/H.264 XAVC S ver.1.0 format compliant

Video: MPEG-4 AVC/H.264
Audio: LPCM 2ch (48 kHz 16 bit)

Movie (AVCHD format):
AVCHD format Ver. 2.0 compatible
Video: MPEG-4 AVC/H.264
Audio: Dolby Digital 2ch, equipped with Dolby Digital Stereo Creator

- Manufactured under license from Dolby Laboratories.

[Recording media]

SLOT 1/SLOT 2: Slot for SD cards (UHS-I and UHS-II compatible)

[Input/output terminals]

USB Type-C terminal:
SuperSpeed USB (USB 3.2 Gen 1)

Multi/Micro USB Terminal*:
Hi-Speed USB (USB 2.0)
* Supports Micro USB compatible devices.

HDMI: HDMI type D micro jack

 (Microphone) terminal:
∅ 3.5 mm Stereo mini jack

 (Headphones) terminal:
∅ 3.5 mm Stereo mini jack

LAN terminal

 (Flash sync) terminal

[General]

Rated input: 7.2 V , 3.9 W

Operating temperature:
0 to 40°C (32 to 104°F)

Storage temperature:
-20 to 55°C (-4 to 131°F)

Dimensions (W/H/D) (Approx.):

128.9 × 96.4 × 77.5 mm
128.9 × 96.4 × 67.3 mm
(from grip to monitor)
5 1/8 × 3 7/8 × 3 1/8 in.
5 1/8 × 3 7/8 × 2 3/4 in.
(from grip to monitor)

Mass (Approx.):
678 g (1 lb 8 oz) (including battery pack, SD card)

[Wireless LAN]

WW942051 (see name plate on the bottom of camera)

Supported format:
IEEE 802.11 a/b/g/n/ac
Frequency band: 2.4 GHz/5 GHz
Security: WEP/WPA-PSK/WPA2-PSK
Connection method:
Wi-Fi Protected Setup™ (WPS)/
Manual

Access method: Infrastructure mode

WW485782 (see name plate on the bottom of camera)

Supported format:
IEEE 802.11 b/g/n
Frequency band: 2.4 GHz
Security: WEP/WPA-PSK/WPA2-PSK
Connection method:
Wi-Fi Protected Setup™ (WPS)/
Manual

Access method: Infrastructure mode

[NFC]

Tag type: NFC Forum Type 3 Tag compliant

[Bluetooth communications]

Bluetooth standard Ver. 4.1
Frequency band: 2.4 GHz

Battery charger BC-QZ1

Rated input:

100 - 240 V , 50/60 Hz, 0.38 A

Rated output: 8.4 V , 1.6 A

Rechargeable battery pack NP-FZ100

Rated voltage: 7.2 V 

Design and specifications are subject to change without notice.

On image data compatibility

- This camera conforms with DCF (Design rule for Camera File system) universal standard established by JEITA (Japan Electronics and Information Technology Industries Association).
- Playback of images recorded with your camera on other equipment and playback of images recorded or edited with other equipment on your camera are not guaranteed.

Trademarks

- XAVC S and  are registered trademarks of Sony Corporation.
- “AVCHD” and the “AVCHD” logotype are trademarks of Panasonic Corporation and Sony Corporation.
- Mac is a trademark of Apple Inc., registered in the United States and other countries.
- iPhone and iPad are trademarks of Apple Inc., registered in the U.S. and other countries.
- Blu-ray Disc™ and Blu-ray™ are trademarks of the Blu-ray Disc Association.
- DLNA and DLNA CERTIFIED are trademarks of Digital Living Network Alliance.
- USB Type-C™ and USB-C™ are trademarks of USB Implementers Forum.
- Dolby, Dolby Audio and double-D symbol are trademarks of Dolby Laboratories.
- The terms HDMI, HDMI High-Definition Multimedia Interface, and the HDMI Logo are trademarks or registered trademarks of HDMI Licensing Administrator, Inc.
- Microsoft and Windows are registered trademarks or trademarks of Microsoft Corporation in the United States and/or other countries.
- SDXC logo is a trademark of SD-3C, LLC.
- Android and Google Play are trademarks or registered trademarks of Google LLC.

- Wi-Fi, the Wi-Fi logo and Wi-Fi Protected Setup are registered trademarks or trademarks of the Wi-Fi Alliance.
- The N-Mark is a trademark or registered trademark of NFC Forum, Inc. in the United States and in other countries.
- The Bluetooth® word mark and logos are registered trademarks owned by the Bluetooth SIG, Inc. and any use of such marks by Sony Corporation is under license.
- QR Code is a trademark of Denso Wave Inc.
- In addition, system and product names used in this manual are, in general, trademarks or registered trademarks of their respective developers or manufacturers. However, the ™ or ® marks may not be used in all cases in this manual.



■ On GNU GPL/LGPL applied software

The software that is eligible for the following GNU General Public License (hereinafter referred to as "GPL") or GNU Lesser General Public License (hereinafter referred to as "LGPL") are included in the product.

This informs you that you have a right to have access to, modify, and redistribute source code for these software programs under the conditions of the supplied GPL/LGPL. Source code is provided on the web. Use the following URL to download it. <http://oss.sony.net/Products/Linux/> We would prefer you do not contact us about the contents of source code.

Licenses (in English) are recorded in the internal memory of your product. Establish a Mass Storage connection between the product and a computer to read licenses in the "PMHOME" - "LICENSE" folder.

Additional information on this product and answers to frequently asked questions can be found at our Customer Support Website.

<https://www.sony.net/>

0-9

- 4K Output Select..... 157
- 24p/60p Output..... 197

A

- A 104
- Access Point Set..... 208
- Add Item 183
- AdobeRGB..... 133
- AEL 116
- AE lock..... 116
- AEL w/ shutter 220
- AF 49
- AF Area Auto Clear..... 218
- AF Area Registration..... 61
- AF-C..... 47
- AF drive speed 222
- AF Illuminator..... 63
- AF in Focus Mag..... 221
- AF/MF control 55
- AF Micro Adj..... 64
- AF On..... 56
- AF-S 47
- AF Tracking Sens. 218, 222
- AF w/ shutter 218
- Airplane Mode 226
- Anti-flicker Shoot..... 76
- Aperture Drive in AF 66
- Aperture Preview 185
- Aperture Priority 104
- APS-C/Super 35mm..... 100
- Area Setting 230
- Aspect 156
- Aspect Ratio..... 100

- Audio Level Display 222
- Audio Out Timing 222
- Audio Rec Level 155
- Audio Recording 154
- Audio recording of movies 154
- Audio signals 226
- Autoflash..... 139
- Auto focus..... 49
- Auto HDR 118
- Auto Mode 43
- Auto Power OFF Temp..... 229
- Auto Review..... 185
- Auto Slow Shutter..... 222
- Auto Switch Media..... 194
- Autumn leaves..... 131
- AVCHD 149
- Av/Tv Rotate 225
- AWB..... 126
- AWB lock 128

B

- Battery pack 36
- Blackout-free shooting 72
- Black & White..... 131
- Bluetooth function..... 203
- Bluetooth Rmt Ctrl 209
- Bluetooth Settings 209
- Bracket Settings 89
- BULB..... 107
- Bulb shooting..... 107

C

- Camera Settings 1 216
- Camera Settings 2..... 222
- Center..... 49, 113, 115, 156

Charging.....	35
Circ. of Focus Point.....	64
Cleaning Mode.....	240
Clear.....	130
Clear Image Zoom.....	123, 124
Clock setting.....	42
Cloudy.....	126
Color Space.....	133
Compatible lenses.....	41
Computer.....	211, 213
Cont. Bracket.....	84
Continuous AF.....	47
Continuous shooting.....	80
Cont. PB for Interval.....	165
Contrast.....	132
Control wheel.....	25
Cont. Shooting.....	79
Cont. Shoot. Length.....	81
Copy.....	166
Copyright Info.....	230
Creative Style.....	130
C.Temp./Filter.....	126
CTRL FOR HDMI.....	199
Ctrl w/ Smartphone.....	226
Custom Key.....	179
Custom white balance.....	127

D

Date/Time Setup.....	42
Daylight.....	126
Deep.....	130
Default values.....	202
Delete.....	174
Delete confirm.....	229
Delete Item.....	184
Del. Regist. AF Area.....	218
Demo Mode.....	230

Dial Ev Comp.....	225
Dial Setup.....	225
Digital zoom.....	123, 124
Diopter-adjustment.....	18
Direct manual focus.....	47, 68
DISP.....	31
DISP Button.....	33
Disp. cont. AF area.....	219
Display as Group.....	228
Display From My Menu.....	184
Displaying vertically oriented images	161
Display Media Info.....	231
Display Rotation.....	161
DMF.....	47, 68
D-Range Optimizer.....	117
Drive Mode.....	79
DRO.....	117
DRO/Auto HDR.....	117, 118
DRO Bracket.....	88

E

Edit Device Name.....	227
e-Front Curtain Shutter.....	78
Electronic Shutter.....	72
Enlarge Image.....	160
Enlarge Initial Mag.....	228
Enlarge Initial Position.....	228
Entire Screen Avg.....	113
Expand Flexible Spot.....	49
Exp. comp. set.....	220
Exposure Comp.....	111
Exposure Set. Guide.....	224
Exposure Std. Adjust.....	220
Exposure step.....	219
Eye AF.....	56, 58
Eye sensor.....	17

Eye-Start AF.....	218	Focus Settings.....	217
F		Focus Standard	53
Face Detection	56, 114	Folder name.....	189, 191
Face/Eye AF Set.....	56	Format.....	189
Face Priority in Multi Metering	114	FTP Transfer Func.....	204
Face Registration	221	Func. of Touch Operation	94, 95
FEL lock	141	Function button	18, 26
File/Folder Settings.....	189	Function Menu Set.....	28
File Format	97, 149	Function Ring (Lens).....	225
File name.....	189	G	
File Settings.....	191	Grid Line.....	224
Fill-flash.....	139	Guideframe	156
Finder Color Temp.....	229	H	
Finder Frame Rate.....	188	HDMI Info. Display	197
FINDER/MONITOR.....	187	HDMI Only (24p).....	157
Flash	138	HDMI Only (25p).....	157
Flash bracket.....	84	HDMI Only (30p).....	157
Flash Comp.....	140	HDMI Resolution.....	196
Flash Mode.....	139	HDMI Settings	196
Flash Off.....	139	HDR	118
Flash sync terminal	143	Help Guide	2
Flexible Spot.....	49	High ISO NR.....	137
Fluor.: Cool White.....	126	Highlight	113
Fluor.: Daylight.....	126	Histogram	32
Fluor.: Day White.....	126	I	
Fn	18, 26	Image Index	163
Focus	47	Image Jump Setting.....	164
Focus Area.....	49	Image sensor	240
Focus Area Limit	52	Imaging Edge.....	213
Focus Frame Color	63	Imaging Edge Mobile	203
Focus indicator.....	48	Import Root Certificate	227
Focus-lock	46	In-Camera Guide.....	2
Focus Magnifier	69	Incandescent.....	126
Focus Magnif. Time.....	221	Index screen.....	163
Focus Mode.....	47		
Focus Point Link.....	115		

Initial Focus Mag	221, 222
Intelligent Auto	43, 102
Interval Shooting	90
IPTC Information	230
IR Remote Ctrl	195
ISO	120
ISO AUTO	120
ISO AUTO Min. SS	121
ISO Range Limit	121
ISO sensitivity.....	120
ISO Setting	120

J

JPEG	97
JPEG Image Size	99
JPEG Quality	98

L

Landscape	130
Language	230
Lens	39
Lens Comp.....	216
Light	130
List of icons	233
Live View Display	224
Location Info. Link Set.....	227
Location information	204
Lock Operation Parts	226
Long Exposure NR.....	136

M

M	106
Manual Exposure	106
Manual Focus.....	47, 67
Marker Display	156
Marker Settings.....	156
Mass Storage.....	211

Memory.....	176
Memory card.....	37, 189, 248
Memory Card + HDMI	157
Memory recall	108
MENU.....	215
MENU button	17, 215
MENU items.....	216
Metering Mode	113
MF.....	47, 67
MF Assist	70
Mode dial	101
Monitor.....	31, 233
Monitor Brightness	229
Mount Adaptor	41, 242
Movie.....	109, 145
MOVIE Button.....	225
Movie file format.....	149
MOVIE (Movie) button	18, 145
Movie w/ shutter	147
MTP	211
Multi	113
Multi Interface Shoe.....	20
Multi-selector.....	26
My Dial Settings	181
My Menu	183, 232

N

Network.....	226
Neutral.....	130
NFC.....	203
Night Scene.....	130
Noise reduction.....	136
NR.....	136
NTSC/PAL Selector	229

O

- One-touch (NFC) 203
- Operating sound 226

P

- P 103
- Pairing 209
- PB Speed for Interval 228
- PC Remote Function 212
- Peaking Setting 221
- Phase Detect. Area 219
- Phase detection AF 52
- Photo Capture 162
- Picture Effect 221
- Playback 159, 227
- Playback speed 153
- Playback zoom 160
- Playing back movies 161
- PlayMemories Home 214
- Portrait 130
- Power Save Start Time 195
- Pre-AF 218
- Printing 228
- Printing the date 43
- Prioritize Rec. Media 38, 192
- Priority Set in AF-C 217
- Priority Set in AF-S 217
- Priority Set in AWB 220
- Program Auto 103
- Program shift 103
- Protect 168
- Proxy Recording 158

Q

- Quick Navi 28

R

- Rating 170
- Rating Set (Custom Key) 171
- RAW 97
- RAW File Type 98
- RAW images 97
- RAW & JPEG 97
- Rear Sync 139
- REC Control 198
- Rec. Media Settings 192
- Recordable number of images 249
- Recordable time of movies 250
- Recording Mode 193
- Record Setting 150
- Recover Image DB 231
- Red Eye Reduction 220
- Reg. Custom Shoot Set 177
- Regist. Faces Priority 221
- Release w/o Card 223
- Release w/o Lens 223
- Remote Camera Tool 214
- Remote commander 195, 209
- Reset EV Comp. 219
- Reset Network Set 227
- Rotate 227

S

- S 105
- Safety Zone 156
- Saturation 132
- Save/Load Settings 201
- Scene recognition 102
- Screen display 31
- Security (IPsec) 227
- Select Media 217
- Select Playback Media 166
- Self-timer 82

Self-timer (Cont)	83	Sunset	130
Self-timer Type	217	Switch V/H AF Area	54
Send to Computer (Wi-Fi)	226	T	
Send to Smartphone Func.	226	TC Output	198
Sensitivity	120	TC/UB Settings	230
Sepia	131	Touch Focus	94
Setting Reset	202	Touch function	93
Setup	229	Touch Operation	93
Shade	126	Touch Pad Settings	230
Sharpness	132	Touch Panel/Pad	93
Shooting still images	45	Touch Tracking	95
Shoot. Start Disp.	76	Tracking	49, 60
Shoot. Timing Disp.	75	U	
Shot. Result Preview	186	Underwater Auto	126
Shutter AWB Lock	128	USB	211
Shutter Priority	105	USB Connection	211
Shutter Type	71	USB LUN Setting	230
Single Bracket	85	USB Power Supply	200
Single Shooting	79	V	
Single-shot AF	47	Version	231
Slideshow	167	Vertical grip	246
Slow Sync.	139	Video Light Mode	223
Smart zoom	123	Viewfinder	31
Software	213	Viewfinder Bright	229
Sort Item	183	View Mode	165
Specifications	253	View on TV (Wi-Fi)	226
Specify Printing	228	Vivid	130
Spot	113	Voice Memo	172
Spot Focus	95	Voice Memo PB Volume	228
Spot Metering Point	115	Volume	162, 229
S&Q	152	Volume Settings	162, 229
S&Q Motion	110		
S&Q Settings	152		
sRGB	133		
SteadyShot	134		
SteadyShot Settings	134		
Style Box	131		

W

WB	126
WB bracket.....	87
White Balance.....	126
Wide	49
Wi-Fi	203
Wi-Fi Settings.....	226
Wind Noise Reduct.	223
Wired LAN Setting.....	227
Wireless Flash	142
Write Serial Number	230

X

XAVC S 4K.....	149
XAVC S HD	149

Z

Zebra Setting.....	224
Zone	49
Zoom	123
Zoom Ring Rotate.....	223
Zoom scale.....	125
Zoom Setting	124, 223