

SONY®

Television

Operating Instructions

Getting Started

Parts and Controls

Connecting TV to the Internet

Watching TV

Navigating through Home Menu

Viewing Pictures from Connected
Equipment

Additional Information

BRAVIA

Sony Customer Support

<http://esupport.sony.com/ES/LA/>

Please Do Not Return
the Product to the Store

Table of Contents

IMPORTANT NOTICE	4
Safety Information	4

Getting Started

Setting Up Your TV	7
Securing the TV	7
Preventing the TV from Toppling	7
Recommended Measures to Secure the TV	8
Precautions	9

Parts and Controls

TV	10
Remote Control	11
Guidelines for Remote Control	13

Connecting TV to the Internet

Setting up the Internet Connection	14
Type 1: Secured network with Wi-Fi Protected Setup™ (WPS)	14
Type 2: Secured network without Wi-Fi Protected Setup™ (WPS)	15
Type 3: Unsecured network with any type of wireless LAN router	15
Type 4: Wired network set-up	15
Preparing a Wired Network	16
Viewing the Network Status	16
If You Cannot Connect to the Internet	16
Privacy Policy	16

Watching TV

Select Your Content Source	17
Adjust Screen Shape and Aspect Ratio	17
Customize Sound and Picture Quality	17
Changing the Viewing Style	18
Changing the Wide Mode	18
Setting Scene Select	18

Navigating through Home Menu

All Apps	19
Photo Sharing Plus	19
Using the TV as a Photo Frame Mode	20
Listening to FM Radio	20
Digital Program List	21
Digital EPG (Electronic Program Guide)	21
Media	21
Playback Photo/Music/Video via USB	21
Home Network	23
Connecting to a Home Network	23
Renderer	23
Display Settings for Media Servers	23
Settings	23
Preferences	23
Customer Support	31

Viewing Pictures from Connected Equipment

Connection Diagram	32
Connecting the TV	33
Showing a Set Top Box with HDMI connection	33
Cable System or VHF/UHF Antenna System	34
Showing HD BRAVIA® Sync™ Basic Connection	35
Showing HD Basic Connection with Home Theater System	36
Showing PC Connection with SD VCR/DVD	37
Using Audio and Video Equipment	38
Using Screen Mirroring	38

Additional Information

Using a Wall-Mount Bracket	39
Detaching the Table-Top Stand from the TV	39
Installing the TV Against a Wall or Enclosed Area	40
Troubleshooting	40
Picture	40
Sound	41
Channels	41
Network	41
General	42
Specifications	43

Introduction

Thank you for choosing this Sony product. Before operating the TV, please read this manual thoroughly and retain it for future reference.

Note

- Images and illustrations used in Setup Guide and this manual are for reference only and may differ from the actual product.

The 48" class has a 47.6 inch (120.9 cm) viewable image size and the 32" class has a 31.5 inch (80.0 cm) viewable image size (measured diagonally).

Location of the Setup Guide

Setup Guide is placed on top of the cushion inside the TV carton.

Location of the identification label

Labels for the TV Model No. and Power Supply rating are located on the rear of the TV. Labels for the AC adapter Model No. and Serial No. are located on the bottom of the AC adapter.

IMPORTANT NOTICE

Owner's Record

The model and serial numbers are located at the side and rear of the TV. Record these numbers in the spaces provided below. Refer to them whenever you call upon your Sony dealer regarding this TV.

Model Name

Serial No.

ADVERTENCIA

Para reducir el riesgo de incendio o descargas eléctricas, no exponga este producto a la humedad ni a la lluvia.



This symbol is intended to alert the user to the presence of uninsulated "dangerous voltage" within the product enclosure that may be of sufficient magnitude to constitute a risk of electric shock to persons.



This symbol is intended to alert the user to the presence of important operating and maintenance (servicing) instructions in the literature accompanying the product.

PRECAUCIÓN

Para evitar descargas eléctricas y exposición a contactos eléctricos, no utilice este enchufe de corriente alterna con un cable de extensión, receptáculo u otro tomacorriente a menos que los contactos eléctricos puedan ser introducidos completamente.

- Operate the TV only on DC 19.5 V (with AC adapter)

Seguridad

- Utilice el cable de alimentación de ca especificado por Sony y que corresponda al voltaje de la zona donde vaya a utilizarlo.
- Por razones de seguridad, el enchufe está diseñado de tal forma que sólo puede conectarse en una dirección en los tomacorrientes de pared. Si no puede introducir completamente los contactos del enchufe en el tomacorriente, póngase en contacto con su distribuidor.
- Si se introduce algún objeto sólido o cae líquido en la unidad, desenchufe el televisor inmediatamente y haga que sea revisado por personal especializado antes de volver a operarlo.
- Desconecte el televisor si no va a utilizarlo durante algunos días. Para ello, tire del enchufe, nunca del cable.
- Consulte la información sobre seguridad en Folleto de instrucciones de seguridad.

Cleaning

When cleaning, be sure to unplug the power cord to avoid any chance of electric shock.

- Wipe the LCD screen gently with a soft cloth.
- Stubborn stains may be removed with a cloth slightly moistened with a solution of mild soap and warm water.
- If using a chemically pretreated cloth, please follow the instruction provided on the package.
- Never use strong solvents such as a thinner, alcohol or benzine for cleaning.
- See the supplied Safety Booklet for additional information.

Safety Information

WARNING

Never place a television set in an unstable location. A television set may fall, causing serious personal injury or death. Many injuries, particularly to children, can be avoided by taking simple precautions such as:

- Using cabinets or stands recommended by the manufacturer of the television set.
- Only using furniture that can safely support the television set.
- Ensuring the television set is not overhanging the edge of the supporting furniture.
- Not placing the television set on tall furniture (for example, cupboards or bookcases) without anchoring both the furniture and the television set to a suitable support.
- Not placing the television set on cloth or other materials that may be located between the television set and supporting furniture.
- Educating children about the dangers of climbing on furniture to reach the television set or its controls.

If your existing television set is being retained and relocated, the same considerations as above should be applied.

NOTE ON AC ADAPTER

Warning

To reduce the risk of fire or electric shock, do not expose this apparatus to rain or moisture.

To prevent fire or shock hazard, do not place objects filled with liquids, such as vases, on the apparatus.

Do not install this equipment in a confined space, such as a bookshelf or similar unit.

- Please ensure that the AC power outlet is installed near the equipment and shall be easily accessible.
- Be sure to use the supplied AC adapter and AC power cord. Otherwise it may cause a malfunction.
- Connect the AC adapter to an easily accessible AC power outlet.
- Do not coil the AC power cord around the AC adapter. The core wire may be cut and/or it may cause a malfunction of the TV.
- Do not touch the AC adapter with wet hands.
- If you notice an abnormality in the AC adapter, disconnect it from the AC power outlet immediately.
- The set is not disconnected from the AC source as long as it is connected to the AC power outlet, even if the set itself has been turned off.
- As the AC adapter will become warm when it is used for a long time, you may feel hot when touching it by hand.

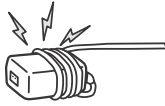

Getting Started

Setting Up Your TV

Some TV models are packaged with a detached Table-Top Stand so you can mount your TV to a wall right away. See page 39 (Using a Wall-Mount Bracket) if you want to mount the TV to a wall. If you are not mounting the TV to a wall, you will need to attach the Table-Top Stand. You will need a Phillips screwdriver (not supplied) and the supplied screws to complete the task. Look for the supplied Setup Guide.

Be sure to consider the following while setting up your TV:

- Disconnect all cables when carrying the TV.
- Carry the TV with the adequate number of people; larger size TVs require two or more people.
- Correct hand placement while carrying the TV is very important for safety and to avoid damage.
- Do not put stress on the LCD panel or the frame around the screen.

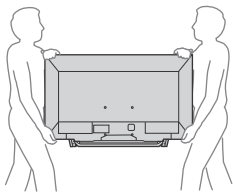

- Ensure your TV has adequate ventilation, see page 40.
- For best picture quality, do not expose the screen to direct illumination or sunlight.
- Avoid installing the TV in a room with reflective wall and floor materials.
- Avoid moving the TV from a cold area to a warm area. Sudden room temperature changes may cause moisture condensation. This may cause the TV to show poor picture and/or poor color. Should this occur, allow moisture to evaporate completely before powering the TV on.

Securing the TV



Sony strongly recommends taking measures to prevent the TV from toppling over. Unsecured TVs may topple and result in property damage, serious bodily injury or even death.

Preventing the TV from Toppling

- Secure the TV to a wall and/or stand.
- Do not allow children to play or climb on furniture and TV sets.
- Avoid placing or hanging items on the TV.
- Never install the TV on:
 - slippery, unstable and/or uneven surfaces.
 - furniture that can easily be used as steps, such as a chest of drawers.
- Install the TV where it cannot be pulled, pushed, or knocked over.
- Install the TV so that the TV's Table-Top Stand does not protrudes out from the Stand (not supplied). If the Table-Top Stand protrudes out from the Stand, it may cause TV set to topple over, fall down, and cause personal injury or damage to the TV.

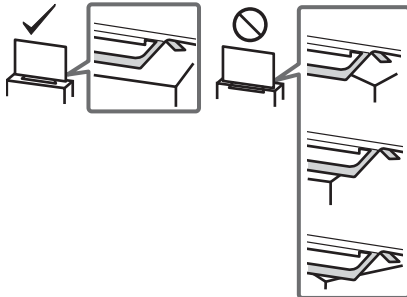

- Route all AC power cords and connecting cables so that they are not accessible to curious children.

US

Getting Started

Recommended Measures to Secure the TV

Consider the following measures when securing your TV to a Stand (not supplied).

- 1 Secure the Stand for the TV. Make sure the Stand can adequately support the weight of the TV. Use two angle braces (not supplied) to secure the Stand.

For each angle brace use the appropriate hardware to:

- Attach one side of the angle brace to the wall stud.
- Attach the other side to the Stand.

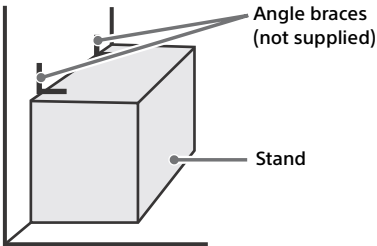

- 2 Secure the TV to the Stand. Use the optional hardware listed as follows (not supplied):

- M6 machine screws (screwed into the TV's rear cover).
- A screw or similar (attach it to the Stand).
- Rope or chain (strong enough to support the weight of the TV). Make sure that there is no excess slack in the rope or chain.

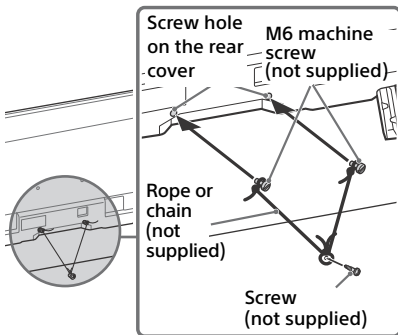

The length of the M6 machine screw differs depending on the rope or chain diameter. Please refer to below illustration.

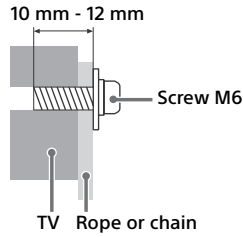

- 3 Anchor the TV to the wall by using bolts, wall anchor and chain (or rope).

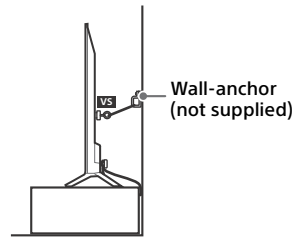
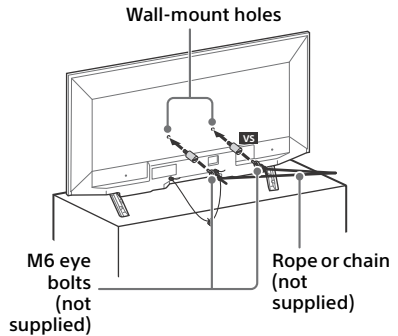

Please see below illustration for M6 eye bolt length.

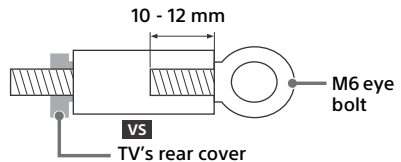

Note

- Securing the TV to the Stand without securing the TV and the Stand to the wall provides minimum protection against the TV toppling over. For further protection, be sure to follow the three measures recommended.

Precautions

How to care for your BRAVIA TV

Safety is very important. Please read and follow the safety documentation (Safety Booklet) separately provided.

Unplug the TV and other connected equipment from the wall outlet before you begin cleaning your TV.



- Wipe the LCD screen gently with a soft cloth.
- Stubborn stains may be removed with a cloth slightly moistened with a solution of mild soap and warm water.
- If using a chemically pretreated cloth, please follow the instruction provided on the package.
- Never spray water or detergent directly on the TV set. It may drip to the bottom of the screen or exterior parts and enter the TV set, and may cause damage to the TV set.
- Never use strong solvents such as a thinner, alcohol or benzine for cleaning.
- Do not plug in the TV into the wall outlet until the moisture from cleaning has evaporated.

The TV should also be placed on a stable surface to prevent it from toppling over (see page 7). If you have young children or pets at home, check regularly to ensure the TV is securely fastened.

TV

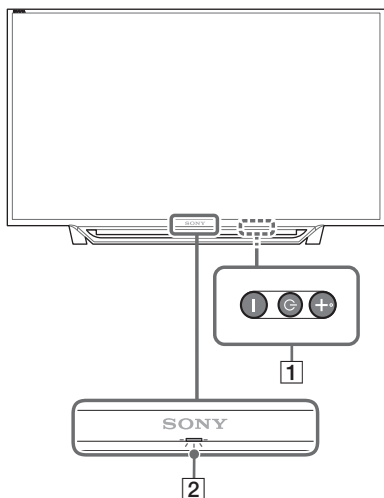

2 (Sensors/LED indicator)

- Receives signals from the remote control.
Do not put anything over the sensor. Doing so may affect its function.
- Lights up in amber when the [Sleep Timer] or [On Timer] is set (page 29), or the TV is in Photo Frame Mode (page 20).
- Lights up in green when [Power Saving] is set to [Picture Off] (page 31).
- Lights up in green when the TV is turned on.
- Does not light up when the TV is in standby mode.
- Flashes while the remote control is being operated.

Note

- Make sure that the TV is completely turned off before unplugging the AC power cord.
- To disconnect the TV from the AC power completely, pull the plug from the AC power outlet.
- Please wait for a while when perform input selection to change to other input.

1 ⏻ (Power) / + / -

Short press ⏻ to turn the TV on.
Long press ⏻ until the TV turn off.

When the TV is on,

Volume

Press + or - button to increase/decrease the volume.

You can also press ⏻ until 🔊 notification is displayed. Increases/decreases the volume by pressing the + or - button.

Input

Press ⏻ until 📺 notification is displayed.

Moves the selected input source by pressing + (up) or - (down) button.

Channel

Press ⏻ until CH notification is displayed.

Select the channel by pressing + (next) or - (previous) button.

Remote Control

The remote control shape, location, availability and function of remote control button may vary depending on your region/country/TV model.

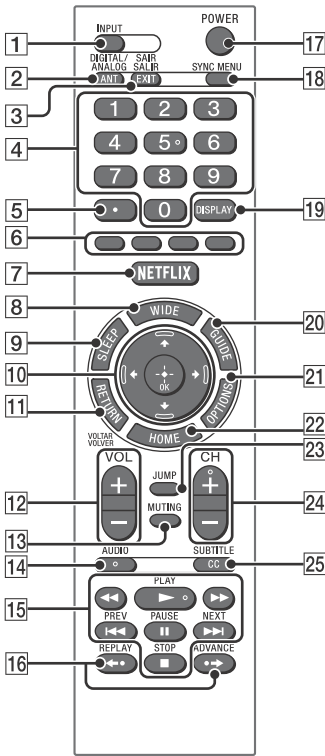

- 1 INPUT**
Displays and selects the input source.
- 2 ANT/DIGITAL/ANALOG**
Switches to digital or analog mode.
- 3 EXIT/SAIR/SALIR**
Press to exit.
- 4 0-9**
Select channels. For channel numbers 10 and above, enter the next digit quickly.
- 5 .**
Use with **0-9** to select digital channels. For example, to enter 2.1, press **(2)**, **(.)**, **(1)** and **(.)**.

- 6 Color buttons**
Displays operation guide (when colored buttons are available).
- 7 NETFLIX (Only on limited region/country/TV model)**
Accesses the "NETFLIX" online service.
- 8 WIDE**
Adjusts the screen display. Press repeatedly to select the desired wide mode (page 18).
- 9 SLEEP**
Press repeatedly until the TV displays the time in minutes [Off]/[15 min]/[30 min]/[45 min]/[60 min]/[90 min]/[120 min] that you want the TV to remain on before shutting off. To cancel the sleep timer, press **SLEEP** repeatedly until [Off] appears.
- 10**
 - Select or adjust items.
 - Confirm selected items.
- 11 RETURN**
 - Returns to the previous screen of any displayed menu.
 - Stops playback when playing photo/music/video file.
- 12 VOL +/-**
Adjust the volume.
- 13 MUTING**
Mutes the sound. Press again to restore the sound.
- 14 AUDIO**
Selects the sound of multilingual source or dual sound for the program currently being viewed (depending on program source).
- 15** **◀◀ (fast rewind)/▶▶ (PLAY)/▶▶ (fast forward)/◀◀ (PREV)/|| (PAUSE)/■ (STOP)/▶▶ (NEXT)**
 - Operate media contents on TV and connected BRAVIA Sync-compatible device.
 - This key also can be used to operate VOD (Video on demand) service playback. Availability is depend on VOD service.

16 ◀• (REPLAY)/•▶ (ADVANCE)
Replays the scene/briefly fast forwards the scene (USB and IPTV Video playback only).

17 POWER
Turns the TV on or switches to standby mode.

18 SYNC MENU
Press to display the BRAVIA Sync Menu and then select connected HDMI equipment from [Device Selection]. The following options can be selected from BRAVIA Sync Menu.

Device Control:

Use the [Device Control] to operate equipment that is compatible with BRAVIA Sync Control. Select options from [Home (Menu)], [Options], [Content List] and [Power Off] to operate the equipment.

Speakers:

Select [TV Speakers] or [Audio System] to output the TV's sound from the TV speakers or connected audio equipment.

TV Control:

Use the [TV Control] menu to operate the TV from the [Home (Menu)] or [Options] menu.

Return to TV:

Select this option to return to TV program.

19 DISPLAY
Displays information. Press once to display information about the program/input you are viewing. Press again to remove the display from the screen.

20 GUIDE
Displays the Digital EPG (Electronic Program Guide) (page 21).

21 OPTIONS
Displays a list that contains shortcuts to some setting menus.
The listed options vary depending on the current input and content.

22 HOME
Displays or cancels the menu.

23 JUMP
Returns to the previous channel or input viewed more than 15 seconds.

24 CH +/-
Select the next (+) or previous (-) channel.

25 CC/SUBTITLE
Changes the subtitle setting (page 28).

Hint

- The number 5, ►, CH + and AUDIO buttons have a tactile dots. Use the tactile dots as references when operating the TV.

Guidelines for Remote Control

- Point your remote control directly at the IR sensor located on your TV.
- Make sure that no objects are blocking the path between the remote control and the IR sensor on your TV.

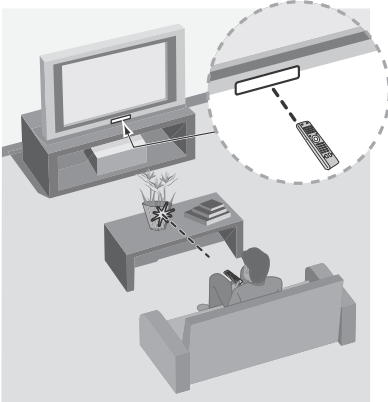

- Fluorescent lamps can interfere with your remote control; try turning off the fluorescent lamps.
- If you are having problems with the remote control, reinsert or replace your batteries and make sure that they are correctly inserted.

Connecting TV to the Internet

Setting up the Internet Connection

To use the network features of your TV it needs to be connected to the Internet. The set-up procedure differs depending on the type of network and LAN router. Before setting up the Internet connection, be sure to set up a LAN router. Check your wireless LAN environment using the following chart.

Wireless LAN

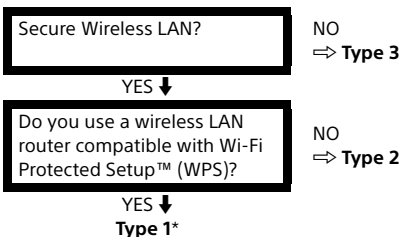

Wired LAN → Type 4

* Type 1 is easier to set up if your router has an automatic setting button, e.g. Air Station One-Touch Secure System (AOSS). Most of the latest routers have this function. Check your router.

Type 1: Follow the configuration for **Secured network with Wi-Fi Protected Setup™ (WPS)**.

Type 2: Follow the configuration for **Secured network without Wi-Fi Protected Setup™ (WPS)**.

Type 3: Follow the configuration for **Unsecured network with any type of wireless LAN router**.

Type 4: Follow the configuration for **Wired network set-up**.

Type 1: Secured network with Wi-Fi Protected Setup™ (WPS)

The WPS standard makes security of a wireless home network as straightforward as pressing the WPS button on the wireless LAN router. Before setting up a wireless LAN, check the location of the WPS button on the router and verify how to use it. For security purpose, [WPS (PIN)] provides a PIN code for your router. PIN code is renewed every time you select [WPS (PIN)].

- 1 Press **HOME**, then select [Settings] → [Preferences] → [Setup] → [Network] → [Network Setup].
- 2 **IP Address setting/Proxy server:**
 - automatic setting:
[Set up network connection] → [Easy]
 - manual setting:
[Set up network connection] → [Expert] → [Wired Set-up] or [Wireless Set-up]
- 3 Select [WPS (Push Button)] for Push Button method or [WPS (PIN)] for PIN method.

Note

Button name of the WPS may differ depending on the router (e.g. AOSS button).

- 4 Follow the instructions on the set-up screen.

Note

- If you use WPS for network set-up, the security settings of the wireless LAN router activate, and any equipment previously connected to the wireless LAN in a non-secure status will be disconnected from the network. In this case, activate the security settings of the disconnected equipment and then reconnect. Or, you can deactivate the security settings of the wireless LAN router, and then connect the equipment to a TV in a non-secure status.
- To use the network with IPv6, select [Settings] → [Preferences] → [Setup] → [Network] → [IPv6/IPv4 Priority] → [IPv6], then select [Easy] in [Set up network connection].
- When IPv6 is selected, HTTP Proxy cannot be set.

Type 2: Secured network without Wi-Fi Protected Setup™ (WPS)

To set up a wireless LAN, SSID (wireless network name) and security key (WEP or WPA key) will be required. If you do not know them, consult the instruction manual of your router.

- 1 Press **HOME**, then select [Settings] → [Preferences] → [Setup] → [Network] → [Network Setup].
- 2 IP Address setting/Proxy server:
 - automatic setting: [Set up network connection] → [Easy]
 - manual setting: [Set up network connection] → [Expert] → [Wired Set-up] or [Wireless Set-up]
- 3 Select [Scan], then select a network from the list of scanned wireless networks.
- 4 Follow the instructions on the set-up screen.

Note

- To use the network with IPv6, select [Settings] → [Preferences] → [Setup] → [Network] → [IPv6/IPv4 Priority] → [IPv6], then select [Easy] in [Set up network connection].
- When IPv6 is selected, HTTP Proxy cannot be set.
- Please make sure your surrounding is secure when you key in your password.

Type 3: Unsecured network with any type of wireless LAN router

To set up a wireless LAN, SSID (wireless network name) will be required.

- 1 Press **HOME**, then select [Settings] → [Preferences] → [Setup] → [Network] → [Network Setup].
- 2 IP Address setting/Proxy server:
 - automatic setting: [Set up network connection] → [Easy]
 - manual setting: [Set up network connection] → [Expert] → [Wired Set-up] or [Wireless Set-up]
- 3 Select [Scan], then select a network from the list of scanned wireless networks.
- 4 Follow the instructions on the set-up screen.

Note

- Security key (WEP or WPA key) will not be required because you do not need to select any security method in this procedure.
- To use the network with IPv6, select [Settings] → [Preferences] → [Setup] → [Network] → [IPv6/IPv4 Priority] → [IPv6], then select [Easy] in [Set up network connection].
- When IPv6 is selected, HTTP Proxy cannot be set.

Type 4: Wired network set-up

Enter the respective alphanumeric values for your router if necessary. The items that need to be set (e.g. IP Address, Subnet Mask, DHCP) may differ depending on the Internet service provider or router. For details, refer to the instruction manuals provided by your Internet service provider, or those supplied with the router.

- 1 Press **HOME**, then select [Settings] → [Preferences] → [Setup] → [Network] → [Network Setup].
- 2 IP Address setting/Proxy server:
 - automatic setting: [Set up network connection] → [Easy]
 - manual setting: [Set up network connection] → [Expert] → [Wired Setup] or [Wireless Setup]
- 3 Follow the instructions on the set-up screen.

[Network Setup] can also be set from [Auto Startup] menu.

Note

- Allows automatic configuration of your wired/wireless network.
 - When connecting with LAN cable: Wired
 - When connecting with built-in Wireless LAN: Wireless
 - When connecting with both of the cables: Wired
- Set to [Easy], sets the IP address automatically. For proxy server is not use.
- To use the network with IPv6, select [Settings] → [Preferences] → [Setup] → [Network] → [IPv6/IPv4 Priority] → [IPv6], then select [Easy] in [Set up network connection].
- When IPv6 is selected, HTTP Proxy cannot be set.

Preparing a Wired Network

TV

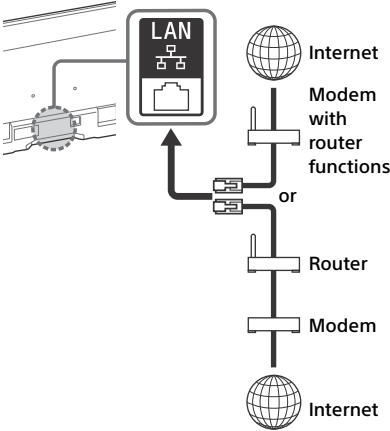

Note

- For LAN connections, use a Category 7 cable (not supplied).

Viewing the Network Status

You can confirm your network status.

- 1 Press **HOME**, then select [Settings] → [Preferences] → [Setup] → [Network] → [Network Setup].
- 2 Select [View Network settings and status].

If You Cannot Connect to the Internet

Use the diagnosis to check possible causes for network connection failures, and settings.

- 1 Press **HOME**, then select [Settings] → [Preferences] → [Setup] → [Network] → [Network Setup].
- 2 Select [View Network settings and status].
- 3 Select [Check Connection].
This may take several minutes. You cannot cancel the diagnosis after selecting [Check Connection].

Privacy Policy

When you use the following functions to connect to the Internet, certain information will be sent to Sony Corporation's global servers, which is considered to be personal information, and requires your agreement in order for service providers to use it.

- System software updates by connecting to Sony Corporation's global servers via the Internet.
- Internet contents or other Internet services from service providers like Youtube.

This TV has the setting screens in Auto Startup or Setting Menu to confirm your agreement to this after you read the detail of Privacy Policy. If you want to use these functions, please check [Agree] in each setting screen. If [Disagree] is checked, the above two functions are not available. However, even in this case, if [ON] is selected at [Automatic Software Download] in Auto Startup or Setting Menu, the system software updating is available. You can change this setting by pressing **HOME**, then select [Settings] → [Preferences] → [Setup] → [Privacy Policy].

Watching TV

- 1 Press  on the TV or **POWER** on the remote control to turn on the TV.
- 2 Press **ANT/DIGITAL/ANALOG** to switch between digital and analog modes.
- 3 Press the number buttons or **CH +/-** to select a TV channel.
- 4 Press **VOL +/-** to adjust the volume.

Select Your Content Source

Whether you are watching cable, satellite or broadcast TV; playing a VCR, DVD or Blu-ray Disc; or connecting to your PC, you need to choose the correct input using your remote control:

- Press the **INPUT** button repeatedly until your selection is highlighted on-screen.

Adjust Screen Shape and Aspect Ratio

High Definition and Standard Definition signals are transmitted with different aspect ratios (the width-to-height ratio of the image).

The 16:9 aspect ratio (common to most HD signals) looks perfect on your **BRAVIA**.



The boxy 4:3 aspect ratio (common to most SD signals) must be adjusted to fill the screen.



- Press the **WIDE** button on your remote control to display the [Wide Mode] setting of your preference.

Customize Sound and Picture Quality

You can choose optimum sound and picture settings to match the content you are displaying on your TV:

- Press the remote control's **HOME** button, select [Settings] → [Preferences], then select the [Picture Adjustments] and [Sound Adjustments] settings to adjust the picture and sound quality of your content.

Refer to your operating instructions manual for more information on adjusting or customizing your settings.

US

Watching TV

Changing the Viewing Style

Changing the Wide Mode

- 1 Press **WIDE** repeatedly to select the wide mode.

[Wide Zoom]*

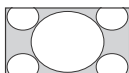

[Normal]

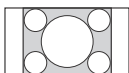

[Full]

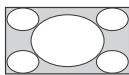

[Zoom]*

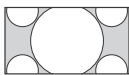

* Parts of the top and bottom of the picture may be cut off.

For HDMI PC Input (PC timing)

[Normal]

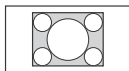

[Full 1]

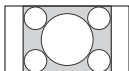

[Full 2]

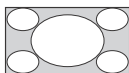

Setting Scene Select

- 1 Press **OPTIONS**.
- 2 Press \uparrow/\downarrow then \odot to select [Scene Select].
When you select the desired scene option, the optimum picture and sound quality for selected scene are automatically set. The options you can select may vary. Unavailable options are greyed out.

Navigating through Home Menu

The **HOME** button allows you to access a variety of TV settings and features.

All Apps

Internet Contents delivers a variety of on-demand entertainment straight to your TV. You can enjoy your favorite internet content, Photo Sharing Plus, Photo Frame Mode and FM Radio.

Note

- Be sure to connect your TV to the Internet and complete [Network Setup] (page 27).

To use Internet Contents

- 1 Press **HOME**, then select [All Apps].
- 2 Press $\uparrow/\downarrow/\leftarrow/\rightarrow$ to select the desired internet service in service list and press \odot .
- 3 Press \odot to launch the desired Internet Contents.

To exit Internet Contents

Press **HOME**.

Note

- If you experience difficulties with this feature, check that the Internet connection is set up properly.
- The interface to Internet content depends on the Internet content providers.
- To update Internet Contents services, Press **HOME**, then select [Settings] → [Preferences] → [Setup] → [Network] → [Refresh Internet Content].

To use NETFLIX

Press **NETFLIX** button on the remote control to launch menu.

Note

- It is possible that Netflix cannot be used via a Proxy server.

Photo Sharing Plus

Connect, view and save favorite photos on TV using your devices (e.g. smartphones or tablets).

HOME → [All Apps] → [Photo Sharing Plus]

Note

- Follow the instructions on the screen to connect your device to the TV.
- Open web browser on device after all connections are established, then follow the instructions on the screen to access the URL.

To display photo on TV

- 1 Tap on your device to start.
- 2 Select a photo.
The selected photo will be displayed automatically on TV.

To save a photo displayed on TV

- 1 Tap thumbnail on your device, then hold the photo to open the context menu.
- 2 Select [OK].

Note

- Connect a USB flash drive to store up to 50 photos.
- Up to 10 smartphones or tablets can be connected to the TV at the same time.
- Maximum file size of each photo is 20 MB.
- You can also throw a background music with a maximum file size of 30 MB.
- The default browser for Android 2.3 or later is supported.
- The default browser for iOS is supported; however, some functions cannot be used depending on the version of your iOS.

Using the TV as a Photo Frame Mode

Photo Frame Mode displays the clock and calendar at the same time as displaying a photo and listening to music or FM radio.

HOME → [All Apps] → [Photo Frame Mode]



To launch Photo Frame Mode while playback USB media

- 1 Press **OPTIONS** while playback a photo or music file.
- 2 Press \uparrow/\downarrow then \ominus to select [Photo Frame Mode] to launch Photo Frame.

To select Display mode

You can change the Photo Frame Mode display by selecting [Display Mode] in the [Photo Frame Settings] (page 28).

To select Clock Display mode

You can select among three clock display modes by selecting [Clock Display] in the [Photo Frame Settings] (page 28).

Note

- This TV does not have a battery powered backup for the clock. If there is a power failure or if you disconnect the power cord, the current date and time will reset automatically.

Duration

To save power, the TV continually plays back in [Photo Frame Mode] for up to 24 hours before powering off automatically. After automatic power off, do not use [Photo Frame Mode] for at least one hour to avoid panel burn-in.

You can change the setting of the [Duration] in the [Photo Frame Settings] (page 28).

To avoid panel burn-in, the position of the photo, clock and calendar are switched automatically every hour.

Listening to FM Radio

HOME → [All Apps] → [FM Radio]

Note

- Press **PROG +/-** to select an FM radio station. Press **RETURN/VOLTAR/VOLVER** to exit FM Radio mode.

Presetting Radio Stations

When you use FM Radio function for the first time, press **HOME** and select [Settings] → [Preferences] → [Channel Setup] → [FM Radio Setup] → [Auto Program].

To change preset radio stations

- 1 Press **OPTIONS** in FM Radio mode.
- 2 Press \uparrow/\downarrow then \ominus to select [FM Radio Presets].
- 3 Press \uparrow/\downarrow then \ominus to select the radio station you want to change.
- 4 Press \uparrow/\downarrow then \ominus to change the FM frequency then to edit FM Radio station name.

Note

- If the station has a noisy sound, you may be able to improve the sound quality by pressing \leftarrow/\rightarrow .
- When an FM stereo program has static noise, press **AUDIO** until [Mono] appears. There will be no stereo effect, but the noise will be reduced.

Digital Program List

- 1 Press **HOME** in digital mode.
- 2 Press \uparrow/\downarrow then \ominus to select [Digital Program List].

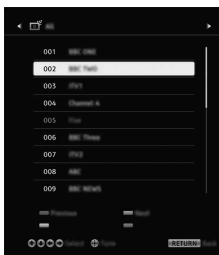

- 3 Press $\uparrow/\downarrow/\leftarrow/\rightarrow$ then \ominus to select a program.

To use the Favourite list

The Favourite feature allows you to specify up to four lists of your favourite programs. While watching TV, press \ominus to create or display a Favourite list.

Hint

- Press the blue button to edit the Favourite list. Follow the guides at the bottom of the screen.

Digital EPG (Electronic Program Guide)

- 1 Press **GUIDE** in digital mode.

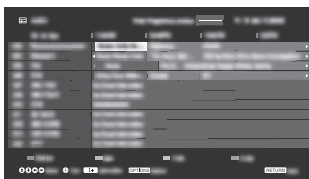

- 2 Press $\uparrow/\downarrow/\leftarrow/\rightarrow$ then \ominus to select a program.

Media

Playback Photo/Music/Video via USB

You can enjoy photo/music/video files stored in a Sony digital still camera or camcorder through a USB cable or USB storage device on your TV.

- 1 Connect a supported USB device to the TV.
- 2 Press **HOME**.
- 3 Press \uparrow/\downarrow then \ominus to select [Media].
- 4 Press \uparrow/\downarrow then \ominus to select [Photo], [Music] or [Video].
- 5 [Device Selection] appears. Press \uparrow/\downarrow then \ominus to select a device.
- 6 Press $\uparrow/\downarrow/\leftarrow/\rightarrow$ then \ominus to select a file or folder.

Playback Method

Press the red color button in thumbnail view to display list of USB playback settings.

To adjust the picture and sound quality of USB media

Press **OPTIONS** during media playback then select [Picture Adjustments] or [Sound Adjustments].

Note

- Press $\uparrow/\downarrow/\leftarrow/\rightarrow$ then \ominus to select and adjust an item.

To play a photo as a slideshow (Photo)

- 1 Press the green button in thumbnail view to start slideshow. To set [Slideshow Effect] and [Slideshow Speed], press **OPTIONS** → [Playback Method]. To stop a slideshow, press **RETURN**.

Note

- While the TV is accessing the data on a USB device, observe the following:
 - Do not turn off the TV.
 - Do not disconnect the USB cable.
 - Do not remove the USB device.The data on the USB device may be damaged.
- Sony will not be held liable for any damage to, or loss of, data on the recording media due to a malfunction of any connected devices or the TV.
- When you connect a Sony digital still camera, set the camera's USB connection mode to "Auto" or "Mass Storage." For more information about USB connection mode, refer to the instructions supplied with your digital camera.
- Use a USB storage device that is compliant with USB Mass Storage Class standards.
- The file system on the USB device supports FAT16, FAT32 and NTFS.
- The file name and folder name may not display correctly in some cases.
- If a selected file has incorrect container information, or is incomplete, it cannot be played back.

USB Video format

- AVI (.avi)
 - Video Codec: MPEG1, MPEG2, XviD, MPEG4, H.264, Motion JPEG
 - Audio Codec: PCM, MPEG1 Layer1/2, MP3, MPEG2 AAC (2ch), MPEG4 AAC (2ch), MPEG4 HE-AAC (2ch), Dolby Digital (2ch), WMA v8, Dolby Digital Plus (2ch)
- ASF (.wmv, .asf)
 - Video Codec: WMV v9, XviD, VC-1
 - Audio Codec: MP3, WMA v8
- MP4 (.mp4, .mov, .3gp)
 - Video Codec: MPEG4, H.264, H.263, Motion JPEG
 - Audio Codec: MPEG1 Layer1/2, MP3, MPEG2 AAC, MPEG4 AAC, MPEG4 HE-AAC
- MKV (.mkv)
 - Video Codec: WMV v9, MPEG4, H.264, VC-1, VP8
 - Audio Codec: PCM, MPEG1 Layer1/2, MP3, MPEG2 AAC (2ch), MPEG4 AAC (2ch), MPEG4 HE-AAC (2ch), Dolby Digital (2ch), WMA v8, Dolby Digital Plus (2ch), DTS, DTS 2.0, VORBIS

- WebM (.webm)
 - Video Codec: VP8
 - Audio Codec: VORBIS
- PS (.mpg, .mpeg, .vro, .vob)
 - Video Codec: MPEG1, MPEG2
 - Audio Codec: MPEG1 Layer1/2, MP3, Dolby Digital (2ch), Dolby Digital Plus (2ch), DTS, DTS 2.0
- TS (.ts, .m2ts)
 - Video Codec: MPEG2, H.264, VC-1
 - Audio Codec: MPEG1 Layer1/2, MP3, MPEG2 AAC, MPEG4 AAC, MPEG4 HE-AAC, Dolby Digital (2ch), Dolby Digital Plus (2ch), DTS, DTS 2.0

USB Music format

- LPCM (.wav)
- MPEG1 audio layer3 (.mp3)
- WMA v8 (.wma)

USB Photo format

- JPEG (.jpg, .jpeg)

Note

- Playback of the above file formats is not guaranteed.

Home Network

Connecting to a Home Network

You can enjoy various content (e.g. photo/music/video files) stored on DLNA Certified™ media servers. The home network feature allows you to enjoy network content in other rooms.

Playing photo/music/video

- 1 Press **HOME**, then select [Media] → [Photo], [Music] or [Video] → the desired media server.
- 2 Select files or folders to play from the list.

Note

- The server is required to be DLNA Certified™.
- Files from a network device need to be in the following formats:
 - Still images: JPEG
 - Music: MP3, linear PCM, WMA
 - Video: AVCHD, MPEG2, MPEG1, MP4 (AVC), MP4 (MPEG4), WMV
- Depending on the file, playback may not be possible even when using the supported formats.

Renderer

You can play back photo, music and video files stored in network devices (e.g. digital still cameras, mobile phones, PC) on the TV screen by directly operating the target device. The network should also be renderer-compatible devices.

Renderer settings

Press **HOME**, then select [Settings] → [Preferences] → [Setup] → [Network] → [Home Network Setup] → [Renderer].

Display Settings for Media Servers

Select home network servers to be displayed in the Home Menu. Up to 10 servers can be displayed.

- 1 Press **HOME**, then select [Settings] → [Preferences] → [Setup] → [Network] → [Home Network Setup] → [Show/Hide Media Servers].
- 2 Select the server to display in the Device Selection.

Settings

Preferences

Note

- The options you can adjust vary depending on the situation. Unavailable options are greyed out or not displayed.

Picture Adjustments

Picture Mode

Sets a picture mode.

Reset

Resets all the [Picture Adjustments] settings except [Picture Mode] to the default settings.

Backlight

Adjusts the brightness of the backlight.

Picture

Increases or decreases picture contrast.

Brightness

Brightens or darkens the picture.

Color

Increases or decreases color intensity.

Hue

Increases or decreases the green tones and red tones.

Color Temperature

Adjusts the whiteness of the picture.

Sharpness

Sharpens or softens the picture.

Reality Creation

Adjusts fineness and noise for realistic picture.

Resolution: Adjusts fineness and clarity. Select [Manual] to adjust the reality creation.

Noise Reduction

Reduces the picture noise (snowy picture) in a weak broadcast signal.

MPEG Noise Reduction

Reduces the picture noise in MPEG-compressed video.

CineMotion

Provides improved picture movement when playing BD (Blu-ray Disc), DVD or VCR images taken on film. Select [Auto] to represent original film-based content as it is.

Note

- If the image contains irregular signals or too much noise, [CineMotion] is automatically turned off even if [Auto] is selected.
-

Advanced Settings

Sets [Picture Adjustments] settings in more detail.

Reset: Resets all the advanced settings to the factory settings.

Adv. Contrast Enhancer:

Automatically adjusts [Backlight] and [Picture] to the most suitable settings for dark images scenes.

Black Corrector: Enhances black areas of the picture for stronger contrast.

Gamma: Adjusts the balance between bright and dark areas of the picture.

Clear White: Emphasises white colors.

Live Color: Makes colors more vivid.

LED Motion Mode: Reduces blur in movies by controlling the LED backlight source, but the brightness decreases.

Sound Adjustments

Sound Mode

Select according to content you want to enjoy.

Reset

Reset [Equalizer], [Clear Voice], [Steady Sound], [Balance] and [Volume Offset] settings.

Equalizer

Adjusts sound frequency settings.

Clear Voice

Makes voices sound clearer.

Steady Sound

Select [On] to stabilize the volume across all programs and commercials. Select [Off] to disable this function.

Balance

Emphasizes left or right speaker balance.

Volume Offset

Adjusts the volume level of the current input relative to other inputs.

MTS Audio

Enjoy stereo, bilingual and mono programs.

Stereo: Select for stereo reception when viewing a program broadcast in stereo.

Auto SAP: Select to automatically switch the TV to second audio programs when a signal is received. If no SAP signal is present, the TV remains in [Stereo] mode.

Mono: Select for mono reception. Use to reduce noise during weak stereo broadcasts.

Advanced Settings

Dynamic Range: Compensates for differences in the audio level between different channels.

Note

- The effect may not function or may vary depending on the program regardless of the [Dynamic Range] setting.

Dolby Digital Plus Out: Select [Auto] to pass through Dolby Digital Plus stream to ARC when Dolby Digital Plus is available through connected Audio System.

During Dolby Digital Plus stream is output, Digital Audio Out (optical)* is muted.

Select [Off] to convert Dolby Digital Plus stream to Dolby Digital for both ARC (Audio system) and Digital Audio Out (optical)*.

HE-AAC Audio Level: Adjust the HE-AAC audio sound level.

MPEG Audio Level: Adjusts the MPEG audio sound level.

* Only on limited region/country/TV model.



Screen

Wide Mode

For details about wide mode, see page 18.

Auto Wide

Automatically changes the wide mode according to the input signal from an external equipment.

4:3 Default

Sets the default [Wide Mode] for a 4:3 input signal.

Auto Display Area

Select [On] to automatically adjust the display area based upon the content or [Off] to choose from the [Display Area] options.

Display Area

Adjusts the picture display area.

H Center

Adjusts the horizontal position of the picture.

V Center

Adjusts the vertical position of the picture.

Vertical Size

Adjusts the vertical size of the picture when [Wide Mode] is set to [Wide Zoom].

PC Settings

Adjust the picture size, see page 18.

Channel Setup

Analog Setup

Cable/Antenna: RF input that connects to your Cable or VHF/UHF antenna.

Analog Auto Tuning: Tunes in all the available analog channels. Usually you do not need to do this operation because the channels are already tuned when the TV was first installed.

However, this option allows you to repeat the process (e.g., to retune the TV after moving house, or to search for new channels that have been launched by broadcasters).

Analog Channel Adjustment: Channel

Selects a channel number.

Analog Fine Tune

[Custom] selection allows you to fine-tune the selected analog channel manually if you feel that a slight tuning adjustment may improve picture quality. Select [Auto] to adjust to the most appropriate analog channel.

Audio Filter

Select [Low] or [High] to improve the sound of individual channels when distortion occurs in mono broadcasts.

Program Sorting: Changes the order in which the channels are stored on the TV.

Show/Hide Channels: Allows you to show or hide channels that appear when you use the CH +/- buttons.

Press \uparrow/\downarrow to scroll through the channels until you find the channel you want to show or hide. Then press \odot to select it. Press \uparrow/\downarrow to determine if the channel will be shown or hidden. Then press \odot to select it.

Edit Channel Labels: Allows you to assign labels (such as station call letters) to channel numbers.

Press \uparrow/\downarrow to scroll through the channel numbers. Then press \odot to select the channel number that you want to assign a label. Press \uparrow/\downarrow to scroll through the label characters (A-Z, 0-9, etc.). Press \rightarrow to move to the next character. Repeat the previous steps to add up to seven characters to the label. When finished, press \odot .

Digital Setup

Digital Tuning:

Digital Auto Tuning

Tunes in the available digital channels. This option allows you to retune the TV after moving house, or to search for new channels that have been launched by broadcasters.

Program List Edit

Removes any unwanted digital channels stored on the TV, and changes the order of the digital channels stored on the TV.

Digital Manual Tuning

Tunes the digital channels manually.

Subtitle Setup:

Subtitle Setting

When [For Hard Of Hearing] is selected, some visual aids may also be displayed with the subtitles (if TV channels broadcast such information).

Primary Preferred Language

Select preferred language which subtitles are displayed in.

Secondary Preferred Language

Select secondary preferred language which subtitles are displayed in.

Audio Setup:

Audio type (Audio description)

Normal

Provide normal audio type.

Audio Description

Provides audio description (narration) of visual information if TV channels broadcast such information.

For Hard Of Hearing

Switches to broadcast for the hearing impaired when [For Hard Of Hearing] is selected.

Spoken subtitle

Switches to broadcast for the spoken subtitle audio if TV channels broadcast such information.

Primary Preferred Language

Select the preferred language used for a program. Some digital channels may broadcast several audio languages for a program.

Secondary Preferred Language

Select the secondary preferred language used for a program. Some digital channels may broadcast several audio languages for a program.

Mixing Level

Adjusts the TV main audio and Audio Description output levels.

Hint

- This option is only available when [Audio Description] in [Audio Type (Audio Description)] is set.

Technical Setup:

Service Replacement

Select [On] to automatically change the channel when broadcaster changes transmission of the viewing program to a different channel.

FM Radio Setup

Presets up to 30 FM radio stations that can be received in your area.

Auto Program: Allows you to automatically tune and store all the available channels.

FM Radio Presets: Allows you to manually tune and store each available channel one at a time.

Note

- To enable this feature, access to FM Radio mode by using Home (Menu) (page 20), then preset your desired FM radio stations according to the steps mentioned above.



Parental Lock

Password

Sets a PIN code to block channels, external inputs and Internet services. Use **0-9** on the remote to enter a four-digit password.

Change Password

Select to change your password.

Rating

Sets an age restriction to viewing. To view any program rated for ages above the age you specify, enter the correct password.

External Input Lock

Locks an external input from being watched. To view a blocked external input, select [Unblocked].

Note

- Entering the correct password for blocked channel or external input will temporarily deactivate the [Parental Lock] feature. To reactivate the [Parental Lock] settings, turn off and on the TV.

Hint

- If you lost your password, see page 43.

Internet Lock

Locks internet contents from being watched.

To view a internet contents, select [Unblocked].



Setup

Network

Network Setup: Sets the network status settings.

IPv6/IPv4 Priority: Switch between [IPv6] and [IPv4 (Recommended)].

Note

- To use the network with [IPv6], select [IPv6], then select [Easy] in [Set up network connection].
- When IPv6 is selected, HTTP Proxy cannot be set.
- When IPv6 is selected, some Internet browser sites, applications or content cannot be watched.

Built-in Wi-Fi: Turns the built-in Wi-Fi [On] or [Off].

Set to [Off], if you do not use the built-in Wi-Fi.

When you switch from [Off] to [On], make the settings in [Network Setup].

Wi-Fi Direct: Turns on/off to connect your TV with Wi-Fi Direct device such as PC, mobile phone or digital camera.

Wi-Fi Direct Settings: Set to connect a Wi-Fi direct device to the TV using the Wi-Fi Direct function. If you cannot connect, press **OPTIONS** key and select [Manual].

Device Name: Change the name of the TV shown on the connected device.

Refresh Internet Content: Connect to the internet to receive available Internet content services.

Home Network Setup:

Show/Hide Media Servers

Displays the connected server list. You can select the server to display in the Device Selection.

Media Server Troubleshooting

Diagnoses whether the TV can connect to each server on the home network.

Remote Start

This feature allow connected device in the home network to turn on the TV.

Note

- This standby power consumption will increase if [On] is set.

Renderer

Renderer

Enables the TV to play media files on a device (e.g. digital still camera).

Renderer Access Control

Allows access from a specified control device.

Renderer Options

Adjusts the [Renderer Options] detailed settings.

Privacy Policy

Select [Agree] or [Disagree] for Privacy Policy confirmation. (page 16)

Photo Frame Settings

Display Mode: Allows you to select the display mode. Select from [Image and Clock], [Full Screen Image] and [Full Screen Clock].

Clock Display: Allows you to select the clock display.

Note

- This option is available when [Display Mode] is set to [Image and Clock] or [Full Screen Clock].

Audio Application: Sets [FM Radio], [Music] or [Off] as audio application.

Image Selection: Select image.

Music Selection: Select music.

Slideshow Setting: Select from showing slideshow mode or single view photo.

Music Playback Setting: Select from listening to all tracks or a single music track.

Duration: Select the time period after which the TV automatically switches to standby mode.

First day of the week: Sets [Sunday] or [Monday] as the first day of the week on the calendar.

USB Auto Start

When USB device is connected to the USB port, select [On] to automatically view the thumbnail of the last played Photo/Music/Video.

Closed Captions (CC)

Allows you to select from several closed caption modes (for programs that are broadcast with closed captioning).

CC Display:

On

[Closed Captions (CC)] is turned on.

Off

[Closed Captions (CC)] is turned off.

On when Muting

[Closed Captions (CC)] is turned on when the TV is muted.

Analog CC: Allows you to select basic analog (EIA-608) closed caption options.

CC1, CC2, CC3, CC4

Displays a printed version of the dialog or sound effects of a program. (Should be set to [CC1] for most programs.)

Text1, Text2, Text3, Text4

Displays network/station information presented using either half or the whole screen (if available).

Clock/Timers

Sets the timer and clock.

Sleep Timer: Sets the time in minutes that you would like the TV to remain on before shutting off automatically.

On Timer: Turns on the TV from standby mode at a time you set, and tuned to a channel or input of your preference or Photo Frame Mode. Before setting this function, make sure you set the correct current time.

Current Time: Sets the current time and date.

Auto/Manual

Select [Manual] to set current time manually.

Automatic time zone

Sets whether or not to automatically select the time zone you are in.

On: Automatically switches between summer time and winter time according to the calendar.

Off: The time is displayed according to the time difference set by [Time Offset].

Automatic daylight saving time

Sets whether or not to automatically switch between summer time and winter time.

Date (Month/Day/Year)

Set current date.

Time

Set Current Time.

Time Offset

Allows you to manually select the time zone you are in, if it is not the same as the default time zone setting for your country/region.

Auto Startup

Starts the initial setup procedure. This option allows you to retune the TV after moving house, or to search for new channels that have been launched by broadcasters.

Language

Select the language in which the menus are displayed.

Startup Logo

Select [On] to display the logo when the TV is turned on. Select [Off] to disable it.

LED Indicator

Select [On] to light up the LED indicator. Select [Off] to disable it.

AV Setup

Manage Inputs: Assigns name to external equipment input. Select [Auto] to display names when the equipment is connected, or [Always] to display regardless of connection status.

Speakers: Select sound output from the TV speakers or external audio equipment.

Headphone/Audio Out: Sets the sound output to headphone, external audio systems or Active Subwoofer connected to the TV. Disconnect headphone from the TV when you select [Audio Out] or [Subwoofer].

Headphone Speaker Link: Switches the TV's internal speakers on/off when you connect headphone to the TV.

Headphone Volume: Adjusts the volume of the headphone.

Note

- This option is not available, when [Headphone/Audio Out] is set to [Audio Out] or [Subwoofer].

Audio Out:

Variable: When using an external audio system, volume output from audio out can be controlled using the TV's remote.

Fixed: The audio output of the TV is fixed. Use your audio receiver's volume control to adjust the volume (and other audio settings) through your audio system.

Hint

- This option is only available when [Headphone/Audio Out] is set to [Audio Out].

Digital Audio Out: Sets the audio signal that is output by connecting using HDMI cable. Set to [Auto], when connecting equipment compatible with Dolby Digital or DTS. Set to [PCM], when connecting equipment not compatible with Dolby Digital or DTS.

TV Position: Improves the speaker settings when set as [Table-Top Stand] or [Wall Mount] according to your TV's position.

BRAVIA Sync Settings

Allows the TV to communicate with equipment that is compatible with the BRAVIA Sync Control function, and connected to the HDMI ports of the TV. Note that communication settings must also be made on the connected equipment.

BRAVIA Sync Control: Sets whether or not to link the operations of the TV and the connected equipment that is compatible with BRAVIA Sync Control. When set to [On], the following functions are available. If the specific Sony equipment that is compatible with BRAVIA Sync Control is connected, this setting is applied to the connected equipment automatically.

Device Auto Power Off: When set to [On], the connected equipment that is compatible with BRAVIA Sync Control turns off when your TV goes to standby mode.

TV Auto Power On: When set to [On], the TV turns on when you turn on the connected equipment that is compatible with BRAVIA Sync Control.

BRAVIA Sync Device List: Displays a list of connected equipment that is compatible with BRAVIA Sync Control.

Select [Enable] to update the [BRAVIA Sync Device List].

Device Control Keys: Select button functions of the TV's remote control to operate the connected equipment.

None

Deactivates the control by the TV's remote.

Normal

For basic operations, such as navigation buttons (up, down, left or right, etc).

Tuning Keys

For basic operations and operation of channel-related buttons, such as **CH +/-** or **(0-9)**, etc. Useful when you control a tuner or set-top box, etc; via the remote control.

Menu Keys

For basic operations and operation of the **HOME/OPTIONS** buttons. Useful when you select menus of a BD player, etc; via the remote control.

Tuning and Menu Keys

For basic operations and operation of channel-related buttons and **HOME/OPTIONS** button.

Note

- Some equipment with [BRAVIA Sync Control] does not support the [Device Control Keys] feature.

Customer Support

Provides information of your TV's model, software, and others. For details, see page 31.



Reset

Resets the current Eco settings to the default values.

Power Saving

Reduces power consumption of the TV by adjusting the backlight. When you select [Picture Off], the picture is switched off. The sound remains unchanged.

Idle TV Standby

Turns the TV off after it has been kept idle for the preset length of time.

Customer Support

Model Name

Displays the model name of your TV.

Software Version

Displays the current software version of your TV.

Digital

Select [System Information] to display channel information of your TV.

External Inputs

View Manage Inputs: Allows you to view or manage the TV and external inputs.

Picture Check

View Test Picture: Allow you to check the picture condition on the display.

Software Update

Updates the TV system using USB memory or via Network.

Note

- Software update via the internet may vary depending on your region/country/TV model.
- To update the software, please visit Sony support website.

Automatic Software Download

Select [On] to download the software automatically. Select [Off] to disable it.

Factory Settings

Resets all settings to factory settings. After completing this process, the initial set-up screen is displayed.

Note

- Be sure not to turn the TV off during this period (it takes about 30 seconds) or press any buttons.

Initialize Personal Information

You can erase your personal information stored in the TV.

Product Information

Displays your TV's product information.

Viewing Pictures from Connected Equipment

Connection Diagram

You can connect a wide range of optional equipment to your TV.

Note

- Depending on TV model, connecting a large USB device may interfere with other connected devices beside it.
- When connecting a large USB device, connect only 1 USB jack.

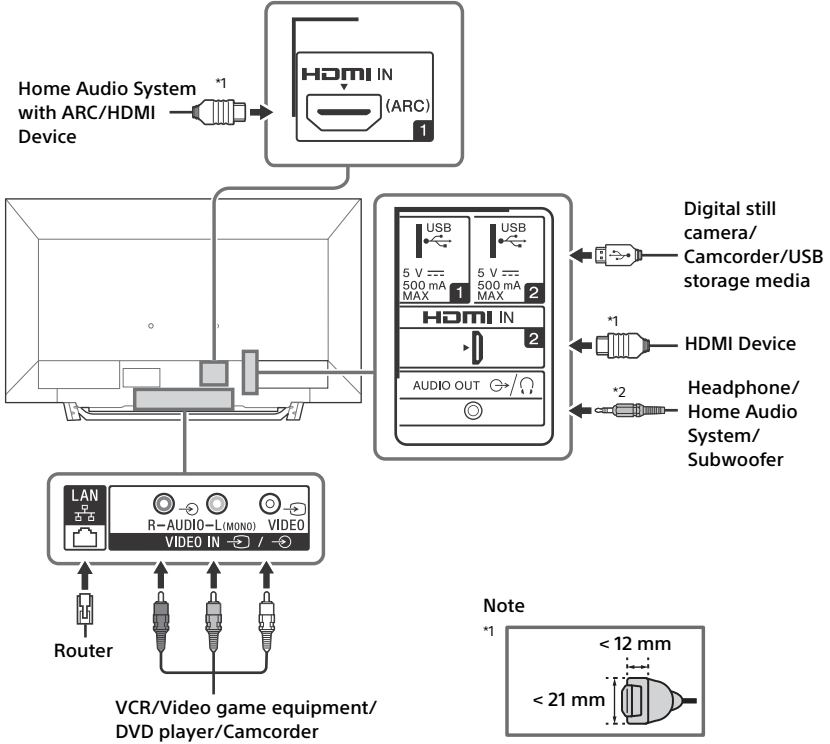

*2 Supports 3-pole stereo mini jack only.

Connecting the TV

Note

- Use an antenna cable connector no greater than 14 mm thick.
- When connecting the cable to the Cable/Antenna, input finger tighten only, over tightening the connection can damage the TV.
- Use an HDMI cable connector within 12 mm (thickness) × 21 mm (width).

Recommendation for an F type plug

Projection of the inner wire from the connection part must be less than 1.5 mm.

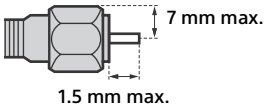

(Reference drawing for an F type plug)

Showing a Set Top Box with HDMI connection

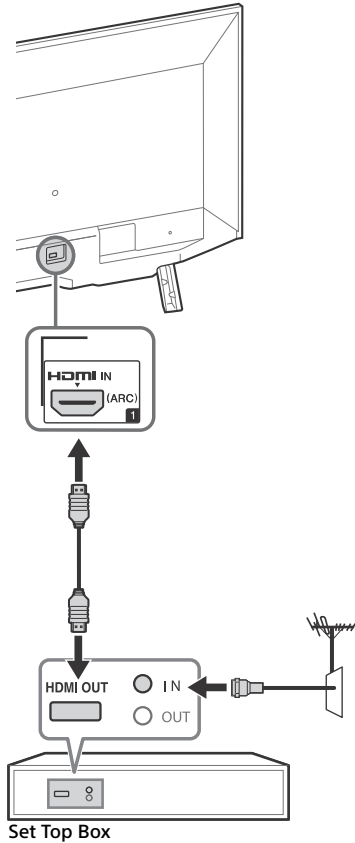

US

Viewing Pictures from Connected Equipment

Cable System or VHF/UHF Antenna System

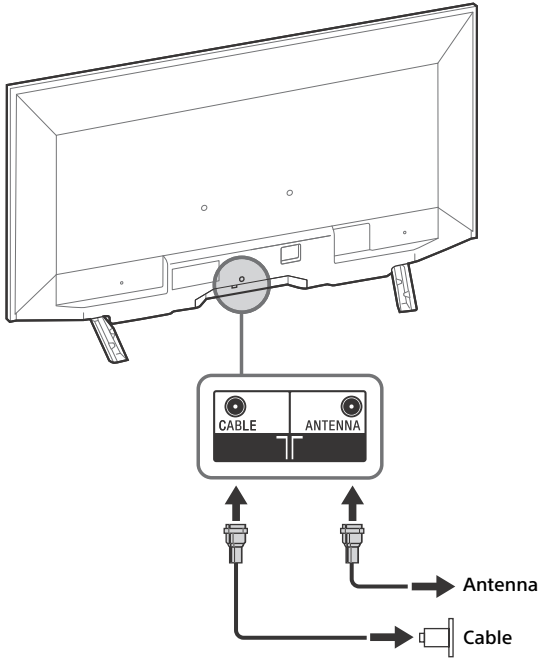

Showing HD BRAVIA® Sync™ Basic Connection

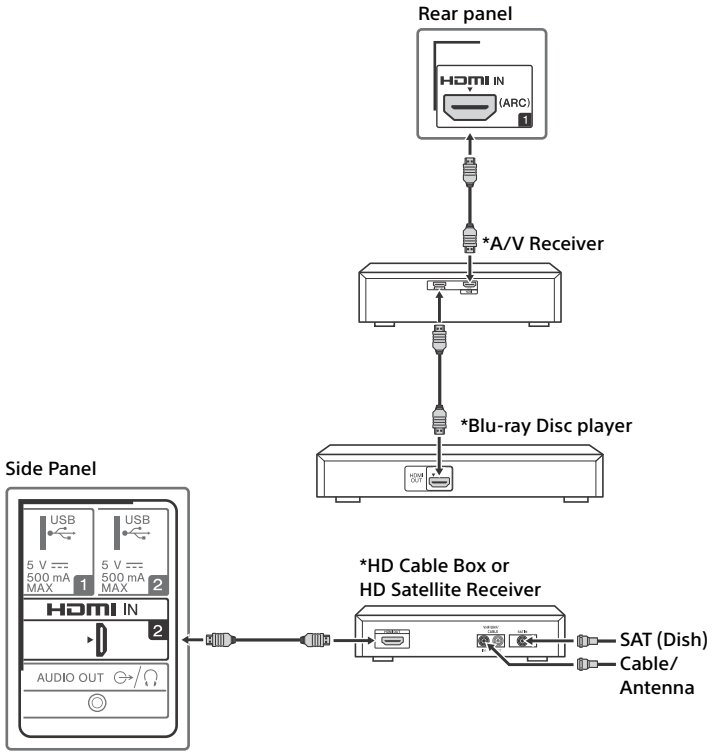

* Signifies a BRAVIA Sync capable device.

Showing HD Basic Connection with Home Theater System

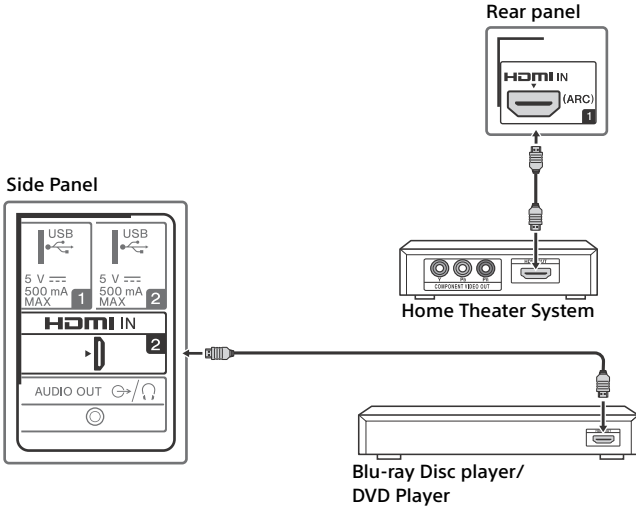

Showing PC Connection with SD VCR/DVD

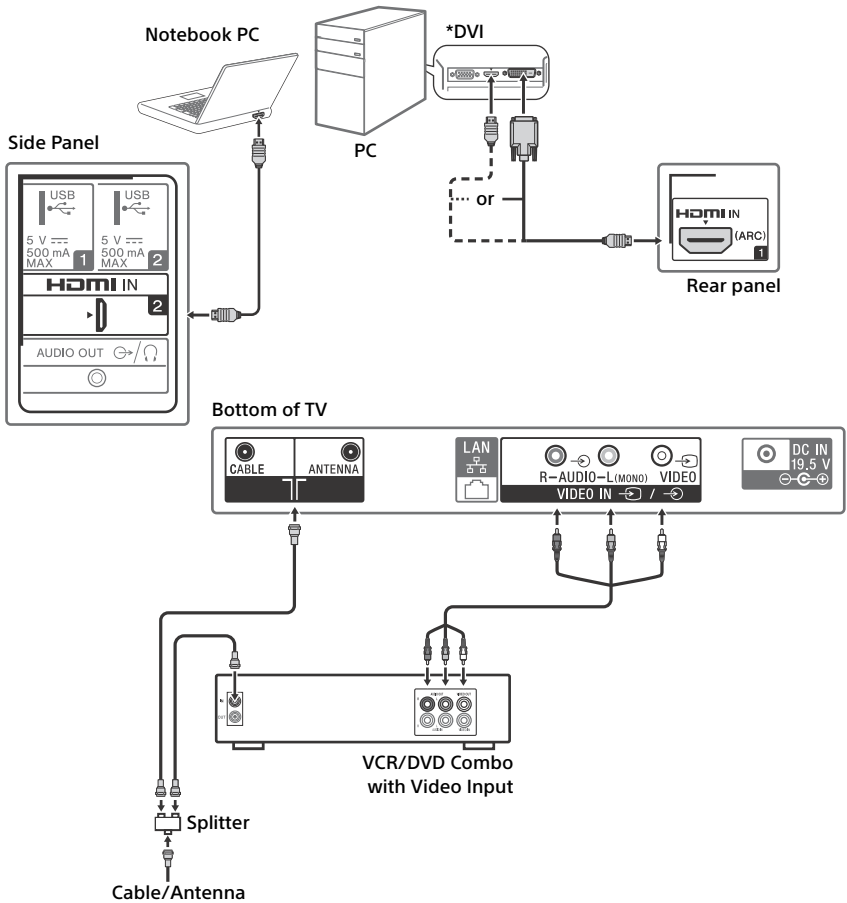

* DVI does not support audio signals. Connect the audio output of the PC to the PC speakers or an A/V receiver to listen to sound from the PC.

Using Audio and Video Equipment

- 1 Turn on the connected equipment.
- 2 Press **INPUT** to display the input source.
- 3 Press \uparrow/\downarrow then \odot to select the desired input source.
The highlighted item is selected if 5 seconds pass without any operation.

Note

- When connecting with an HDMI cable, be sure to use HighSpeed HDMI Cable with Cable Type Logo (Recommended SONY Cable).
- When connecting mono equipment, connect the audio cable to the L (mono) jack.

To use BRAVIA Sync devices

When connecting the TV to BRAVIA Sync compatible equipment, you can control them together.

Be sure to perform the necessary settings in advance. The BRAVIA Sync Control settings must be set on both the TV and the connected equipment. See [BRAVIA Sync Settings] (page 30) for the settings on the TV side. Refer to the connected equipment operating instructions for the settings on the connected equipment side.

Using Screen Mirroring

Screen mirroring displays the screen of a compatible device (e.g. smartphones) on your large TV screen by Miracast technology.

No wireless router (or access point) is required to use this feature.

- 1 Press **INPUT** button, then select [Screen mirroring] using \uparrow/\downarrow buttons.
- 2 Operate the Screen mirroring compatible device to connect with the TV. Once connected, the device screen will be displayed on the TV.

To show connected devices/delete device

When the waiting screen for the Screen mirroring is displayed, press **OPTIONS**, then select [Show Device List / Delete].

To deregister a device, select the device in the list to delete, press \odot . Then, select [Yes] in the confirmation display.

To display registration notification when attempting to connect a device with the TV

Activating this function can avoid an unintended device from being connected. When the standby screen for Screen mirroring is displayed, press **OPTIONS**, then select [Registration Notification] \rightarrow [On]. Note that once you decline registration request from a device, you will not be able to connect the device unless you delete it from the device list.

To change the band setting (for experts)

When the standby screen for Screen mirroring is displayed, press **OPTIONS**, then select [Band Setting].

Note

- Connecting devices must conform to the following:
 - Screen mirroring compatible devices: 2.4GHz connection (5GHz not supported).
- For information about the supported wireless band of your device, refer to the instruction manual of your device.

Additional Information

Using a Wall-Mount Bracket

This TV's instruction manual only shows the steps on preparing the installation of the TV before installing to the wall.

Your TV can be mounted on a wall using a Wall-Mount Bracket (not supplied) out of the box as packaged. If the Table-Top Stand is attached to the TV, the TV may require detaching the Table-Top Stand; see page 39 (Detaching the Table-Top Stand from the TV).

Prepare the TV for the Wall-Mount Bracket before making cable connections.

For product protection and safety reasons, Sony strongly recommends that installation of your TV on the wall be performed by qualified professionals. Do not attempt to install it yourself.

- Follow the instruction guide provided with the Wall-Mount Bracket for your model. Sufficient expertise is required in installing this TV, especially to determine the strength of the wall for withstanding the TV's weight.
- The length of the screw for Wall-Mount Bracket differs depending on the Wall-Mount Bracket thickness. Please see below illustration.

10 mm - 12 mm

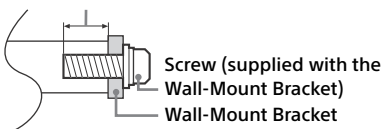

- Be sure to store the unused screws and Table-Top Stand in a safe place until you are ready to attach the Table-Top Stand. Keep the screws away from small children.

Note

- Read the supplied Safety Booklet for additional safety information.

Detaching the Table-Top Stand from the TV

To detach the Table-Top Stand from the TV, remove the screws.

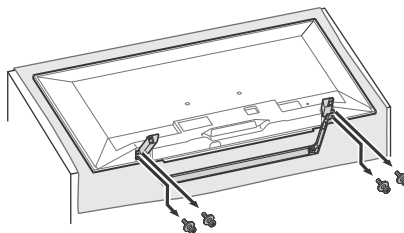

Note

- Do not remove the Table-Top Stand for any reason other than to install corresponding accessories on the TV.
- When removing the Table-Top Stand from the TV, lay the display face down on a stable work surface that is larger than the TV.
- To prevent damaging the surface of the LCD display, make sure to place a soft cloth on the work surface.
- Be sure the TV is vertical before turning on. To avoid uneven picture uniformity do not power on the TV with the LCD panel facing down.
- When attaching the Table-Top Stand again, be sure to fasten the screws (previously removed) to the original holes on the rear of the TV.

US

Additional Information

Installing the TV Against a Wall or Enclosed Area

Make sure that your TV has adequate ventilation. Allow enough space around the TV as shown below.

Installed with Stand

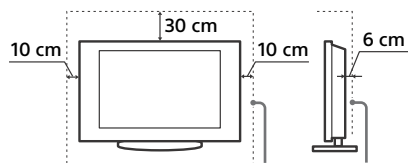

Leave at least this much space around the set.

Installed on the wall

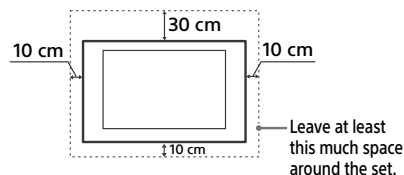

Leave at least this much space around the set.

Never install the TV set as follows:

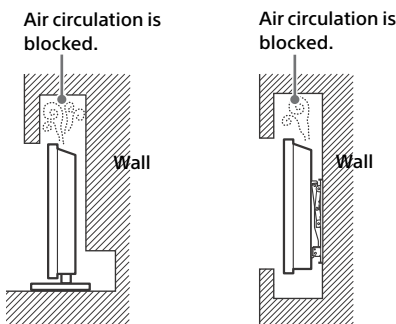

Note

- Inadequate ventilation can lead to overheating of the TV and may cause TV damage or cause a fire.

Troubleshooting

When the LED indicator is flashing red, count how many times it flashes (interval time is three seconds).

If the LED indicator flashes red, reset the TV by disconnecting the AC power cord from the TV for two minutes, then turn on the TV. If the problem persists, contact Sony Customer Support (information provided on the front cover) with the number of times the LED indicator flashes red (interval time is three seconds).

Press  on the TV to turn it off, disconnect the AC power cord, and contact Sony Customer Support.

When the LED indicator is not flashing, check the items as follows.

If the problem persists, have your TV serviced by qualified service personnel.

Picture

No picture (screen is dark) and no sound

- Check the cable/antenna connection.
- Connect the TV to the AC power outlet, and press  on the TV or **POWER** on the remote control.

No picture or no menu information from equipment connected to the video input jack appears on the screen

- Press **INPUT** to display the connected equipment list, then select the desired input.
- Check the connection between the optional equipment and the TV.

Double images or ghosting

- Check the cable/antenna connection, location or direction.

Only snow and noise appear on the screen

- Check if the antenna is broken or bent.
- Check if the antenna has reached the end of its serviceable life (three to five years in normal use, one to two years at the seaside).

Distorted picture (dotted lines or stripes)

- Keep the TV away from electrical noise sources such as cars, motorcycles, hair-dryers or optional equipment.
- When installing optional equipment, leave some space between the optional equipment and the TV.
- Check the cable/antenna connection.

- Keep the antenna cable away from other connecting cables.

Picture or sound noise when viewing a TV channel

- Make sure that the antenna is connected using a 75-ohm coaxial cable (not supplied).
- Keep the antenna cable away from other connecting cords.
- To avoid TV interference, make sure to use an undamaged antenna cable.

Tiny black points and/or bright points appear on the screen

- The picture of a display unit is composed of pixels. Tiny black points and/or bright points (pixels) on the screen do not indicate a malfunction.

Picture contours are distorted

- Change the current setting of [CineMotion] to other settings (page 24).

No color on programs

- Select [Reset] (page 23).

No picture from the connected equipment appears on the screen

- Turn the connected equipment on.
- Check the cable connection.
- Press **INPUT** to display the connected equipment list, then select the desired input.
- Correctly insert the memory card or other storage device in the digital still camera.
- Use a digital still camera memory card or other storage device that has been formatted according to the instruction manual supplied with the digital still camera.
- Operations are not guaranteed for all USB devices. Also, operations differ depending on the features of the USB device and the video being played.

Cannot select the connected equipment on the menu or cannot switch the input

- Check the cable connection.

Sound

No sound, but good picture

- Press **VOL +/-** or **MUTING**.
- Check if [Speakers] in [AV Setup] is set to [TV Speakers] (page 29).
- Check if the headphone plug is connected to the TV.

No sound or noisy sound

- Check if the TV system setting is appropriate (page 24).

Channels

The desired channel cannot be selected

- Switch between digital and analog mode and select the desired digital/analog channel.

Some channels are blank

- The channel is for scrambled/subscription service only. Subscribe to a pay TV service.
- Channel is used only for data (no picture or sound).
- Contact the broadcaster for transmission details.

Network

What kind of devices can be connected to use the Screen mirroring function?

- Sony Screen mirroring compatible devices (Xperia) can be connected.

Video or sound sometimes cuts out

- Devices emitting radio waves, such as other wireless LAN devices or microwave ovens, may interfere with the Screen mirroring function using wireless LAN. Keep the TV or Sony Screen mirroring compatible devices (Xperia) away from such devices, or turn them off if possible.
- Communication speed may change according to the distance or obstacles between devices, device configuration, radio wave condition, line congestion or what device you use. Communication may cut out due to the radio wave condition.

Some pay contents cannot be played

- The source device needs to be compatible with HDCP (High-bandwidth Digital Content Protection) 2.0/2.1 system. Some pay contents may not be displayed via a non-compatible source device.

Apps are inaccessible

- Check that the LAN cable or AC power cord of the router/modem* has been connected properly.
- * Your router/modem must be set in advance to connect to the Internet. Contact your Internet service provider for router/modem settings.
- Try using apps later. The app content provider's server may be out of service.

Sometimes video streaming quality is poor when using the wireless LAN

- The wireless network connection quality varies depending on the distance or obstacles (e.g. wall) between the TV and the wireless router (access point), environment interference, and quality of the wireless router (access point).

Wireless LAN connection fails or radio reception conditions are poor

- Check the installation location of the TV and wireless router (access point). Signal condition may be affected for the following reasons.
 - Other wireless devices, microwaves, fluorescent lights, etc., are placed nearby.
 - There are floors or walls between the wireless router (access point) and TV. If the problem persists even after checking the above, try making a wired LAN connection.

Poor picture on Internet Video

- Quality depends on the original video provided by the internet contents provider and your connection bandwidth.

Certain internet contents displays a loss of detail, especially during fast-motion or dark scenes

- Video quality and picture size depend on broadband speed and delivery by content providers.

Good picture quality but no sound on the internet contents

- Quality depends on the original content provided by the internet contents provider and your connection bandwidth.
- Due to the nature of Internet video, not all videos will contain sound.

Your TV cannot connect to the server

- Check the LAN cable or connection to your server and your TV.
- Check if your network is properly configured on your TV.

A message appears stating that the TV cannot connect to your network

- Check the current network settings. Press **HOME**, then select [Settings] → [Preferences] → [Setup] → [Network] → [Network Setup] → [View Network settings and status]. If all of your network settings are “-”, your server may not be connected properly. Check your network connections and/or server’s instruction manual for connection information.
- Reconfigure your network settings.

- If the LAN cable is connected to an active server and the TV has acquired an IP address, check your DLNA Certified™ media server’s connections and configurations.

Note

- Your IP address configuration can be viewed by selecting the [View Network settings and status] option.

DLNA Certified™ media server is inaccessible although it is listed under [Media] in the Home Menu

- Check your LAN cable/connection or your server connections. The TV may have lost connection with the server.
- Perform [Media Server Troubleshooting] to check if your media server is properly communicating with the TV. Press **HOME**, then select [Settings] → [Preferences] → [Setup] → [Network] → [Home Network Setup] → [Media Server Troubleshooting].

When using the renderer function, music files cannot be played back

- Some applications display a photo file pre-installed in the PC simultaneously with music playback when using the renderer function. Depending on the pre-installed photo file, music playback may not be possible, but may become possible by changing the photo file.

You could not connect Internet

- Check that the LAN cable or AC power cord of the router/modem* has been connected properly.

* Your router/modem must be set in advance to connect to the Internet. Contact your Internet service provider for router/modem settings.

You do not have YouTube ID

- If you do not have a YouTube ID and password, register them through the address below.

<http://www.google.com/device>
(You can also register a YouTube ID and password from your PC.)

After registering your ID, you can use it immediately.

General

The TV turns off automatically (the TV enters standby mode)

- Check if the [Sleep Timer] is activated (page 29).
- Check if the [Duration] is activated by [On Timer] (page 29) or [Photo Frame Settings] (page 28).

- Check if the [Idle TV Standby] is activated (page 31).

Some input sources cannot be selected

- Select [Manage Inputs] and select [Always] of the input source (page 29).

The remote control does not function

- Replace the batteries.

HDMI equipment does not appear on BRAVIA Sync Device List

- Check that your equipment is compatible with BRAVIA Sync Control.

Cannot select Off in BRAVIA Sync Control

- If you have connected any audio system that is compatible with BRAVIA Sync Control, you cannot select [Off] in this menu. To change the audio output to the TV speaker, select [TV Speakers] in the [Speakers] menu (page 29).

The Parental Lock password has been forgotten

- Enter 9999 for the password.
- Update password by pressing **HOME** and select [Settings] → [Preferences] → [Parental Lock] → [Change Password].

Store Display Mode or Promoting Feature Logo appears on the screen

- On the remote control, press **RETURN** then press **HOME** and select [Settings] → [Preferences] → [Setup] → [Auto Startup]. Be sure to select [Home] in [Location].

The **⏻**, **+**, and **-** buttons cannot be located on the TV.

- See below illustration for location of the buttons on the TV.

Front of TV

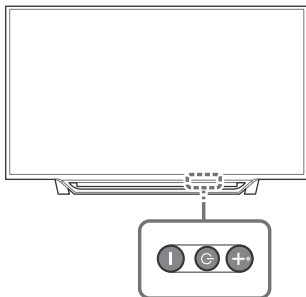

Specifications

System

Television system

Analog: NTSC

Digital: DVB-T/DVB-T2

Channel coverage

Depending on your country/area selection

Analogue: UHF/VHF/Cable

Digital: UHF/VHF

Panel system

LCD (Liquid Crystal Display) Panel, LED

Backlight

Speaker output

5 W + 5 W

Wireless technology

Protocol IEEE802.11b/g/n

Input/Output jacks

CABLE/ANTENNA

75 ohms external terminal for RF inputs

VIDEO IN

Video input (phono jack)

AUDIO IN

Audio input (phono jacks)

HDMI IN 1 (ARC), HDMI IN 2

HDMI Video: 1080p(30, 60 Hz), 1080/24p, 1080i(60 Hz), 720p(30, 60 Hz), 720/24p, 480p, 480i

PC input:

(Resolution, Horizontal frequency, Vertical frequency)

For KDL-48W657D / 40W657D

640 × 480, 31.5 kHz, 60 Hz

800 × 600, 37.9 kHz, 60 Hz

1,024 × 768, 48.4 kHz, 60 Hz

1,280 × 768, 47.4 kHz, 60 Hz

1,280 × 768, 47.8 kHz, 60 Hz

1,360 × 768, 47.7 kHz, 60 Hz

1,280 × 1,024, 64.0 kHz, 60 Hz

*1,920 × 1,080, 67.5 kHz, 60 Hz

* The 1080p timing when applied to the HDMI input will be treated as a video timing and not PC timing

For KDL-32W607D

640 × 480, 31.5 kHz, 60 Hz

800 × 600, 37.9 kHz, 60 Hz

1,024 × 768, 48.4 kHz, 60 Hz

1,280 × 768, 47.4 kHz, 60 Hz

1,280 × 768, 47.8 kHz, 60 Hz

1,360 × 768, 47.7 kHz, 60 Hz

Audio: Two channel linear PCM 32, 44.1 and 48 kHz, 16, 20 and 24bits, Dolby Digital, Dolby Digital Plus, DTS

ARC (Audio Return Channel) (HDMI IN 1 only)

PCM, Dolby Digital, Dolby Digital Plus, DTS

↻ AUDIO OUT/🔊 (Stereo mini jack)
Headphone, Audio output, Subwoofer

♂1, ♀2

USB port

DC IN 19.5 V ⚡⊖⊕
AC adapter input

🔌 LAN

10BASE-T/100BASE-TX connector (Connection speed may differ depending on the network environment. 10BASE-T/100BASE-TX communication rate and communication quality are not guaranteed for this TV.)

KDL-48W657D: 10.7 kg

KDL-40W657D: 8.1 kg

KDL-32W607D: 5.2 kg

without stand

KDL-48W657D: 10.2 kg

KDL-40W657D: 7.7 kg

KDL-32W607D: 4.9 kg

* Dimensions and mass are approximate values.

- Optional accessories availability depends on countries/region/TV model/stock.
- Design and specifications are subject to change without notice.

Others

Operating temperature

0 °C – 40 °C

Power and others

Power requirement

19.5 V DC with AC adapter

Rating: Input 110 V - 240 V AC, 50/60 Hz

Power consumption

in use:

KDL-48W657D: 75 W

KDL-40W657D: 59.4 W

KDL-32W607D: 45 W

in standby:

0.50 W

Screen size* (measured diagonally)

KDL-48W657D: 120.9 cm / 47.6 inches
(48" Class)

KDL-40W657D: 101.6 cm / 40 inches

KDL-32W607D: 80.0 cm / 31.5 inches

(32" Class)

Display resolution

KDL-48W657D / 40W657D: 1,920 dots
(horizontal) × 1,080 lines (vertical)

KDL-32W607D: 1,366 dots (horizontal) ×
768 lines (vertical)

Dimensions*

with stand

KDL-48W657D: 1,092 × 683 × 235 mm

KDL-40W657D: 924 × 589 × 212 mm

KDL-32W607D: 735 × 481 × 174 mm

without stand

KDL-48W657D: 1,092 × 643 × 66 mm

KDL-40W657D: 924 × 549 × 66 mm

KDL-32W607D: 735 × 446 × 66 mm

wall-mount hole pattern

200 × 200 mm

wall-mount screw size (mm)

M6 (length: refer to diagram on page 39)

Mass*

with stand

Licensing Information

- The terms HDMI and HDMI High-Definition Multimedia Interface, and the HDMI Logo are trademarks or registered trademarks of HDMI Licensing LLC in the United States and other countries.
- Manufactured under license from Dolby Laboratories. Dolby, Dolby Audio, and the double-D symbol are trademarks of Dolby Laboratories.
- "BRAVIA" y BRAVIA, Motionflow, BRAVIA Sync y 📺 son marcas comerciales o marcas registradas de Sony Corporation.
- Opera® Devices SDK from Opera Software ASA. Copyright 1995-2015 Opera Software ASA. All rights reserved.
- Wi-Fi, Wi-Fi Direct, Miracast, Wi-Fi Protected Setup and Wi-Fi CERTIFIED Logo are trademarks or registered trademarks of Wi-Fi Alliance.
- "Blu-ray Disc", "Blu-ray" and "Blu-ray Disc" logo are trademarks of Blu-ray Disc Association.
- "PlayStation" is a registered trademark and "PS3" is a trademark of Sony Computer Entertainment Inc.
- For DTS patents, see <http://patents.dts.com>. Manufactured under license from DTS, Inc. DTS, the Symbol, & DTS and the Symbol together are registered trademarks, and DTS 2.0+Digital Out is a trademark of DTS, Inc. © DTS, Inc. All Rights Reserved.
- TUXERA is a registered trademark of Tuxera Inc. in the US and other countries.

- Windows Media is either a registered trademark or trademark of Microsoft Corporation in the United States and/or other countries.
- This product contains technology subject to certain intellectual property rights of Microsoft. Use or distribution of this technology outside of this product is prohibited without the appropriate license(s) from Microsoft.



For Your Convenience

Online Registration:	Be sure to register your TV. http://esupport.sony.com/LA/perl/registration.pl
Software Updates:	Your TV is capable of receiving software updates. For the latest information about software updates for your TV, visit: http://esupport.sony.com/LA/