

Recommended pages in the Help Guide

[Finding functions from MENU](#)

You can check the list of the menu items. You can also move to the explanation page for each item from the menu item on the list.

[Bluetooth Rmt Ctrl](#)

You can operate the camera using a Bluetooth compatible remote commander (sold separately) or shooting grip (sold separately).

[File Format \(movie\)](#)

You can select the movie file format.

[S&Q Settings](#)

You can record a moment that cannot be captured by the naked eye (slow-motion recording), or record a long-term phenomenon into a compressed movie (quick-motion recording).

[Assigning frequently used functions to buttons \(Custom Key Setting\)](#)

You can assign frequently used functions to the desired buttons.

Support information

[Looking for valuable information, such as essential points on shooting](#)

This website introduces convenient functions, ways of usage, and setting examples. Refer to the website when you set up your camera.

[Firmware, Questions & Answers and Compatibility](#)

This website provides Firmware update, Question & Answers and Compatibility information

[How to use the "Help Guide"](#)

Notes on using your camera

[Precautions](#)

[Lending, transferring or discarding the camera and/or memory card to others \(Notes on protecting private information\)](#)

[Notes on the battery pack and charging the battery.](#)

[Notes on memory card](#)

[On cleaning](#)

[Checking the camera and the supplied items](#)

Names of parts

[Identifying parts](#)

[Basic icons displayed on the monitor](#)

Basic operations

[Touch panel](#)

[Touch function icons](#)

[Control wheel](#)

[Still/Movie/S&Q button](#)

[MENU button](#)

[Main menu \(shooting setting list\)](#)

[Fn \(function\) button](#)

[C \(custom\) buttons](#)

[DISP \(Display Setting\) button](#)

[Delete button](#)

[Keyboard screen](#)

[In-Camera Guide](#)

Preparing the camera/Basic shooting operations

Charging the battery pack

— [Inserting/removing the battery pack](#)

— [Charging the battery with a commercially available AC adaptor or mobile battery](#)

— [Using the battery charger abroad](#)

[Supplying power from a wall outlet \(wall socket\)](#)

[Memory cards that can be used](#)

[Inserting/removing a memory card](#)

[Performing initial setup for the camera](#)

Basic shooting operations

- [Confirmation before shooting](#)

- [Shooting movies \(Intelligent Auto\)](#)

- [Shooting still images \(Intelligent Auto\)](#)

[Finding functions from MENU](#)

Using the shooting functions

[Contents of this chapter](#)

Selecting a shooting mode

- [Shoot Mode \(still image\)/Shoot Mode \(movie\)/Shoot Mode \(S&Q\)](#)

- [Shoot Mode: Intelligent Auto](#)

- [Shoot Mode: Scene Selection](#)

- [Adjusting images in the auto mode \(My Image Style\)](#)

- [Shoot Mode: Program Auto](#)

- [Shoot Mode: Aperture Priority](#)

- [Shoot Mode: Shutter Priority](#)

- [Shoot Mode: Manual Exposure](#)

Convenient functions for shooting self-portrait videos and vlogs

- [Product Showcase Set](#)

- [Background Defocus](#)

- [Cinematic Vlog Set](#)

- [Self-timer \(movie\)](#)

Focusing

- [Selecting the focus method \(Focus Mode\)](#)

- [Selecting the focus area \(Focus Area\)](#)

- [Tracking subject \(Tracking function\)](#)

[Manual Focus \(Set Focus\)](#)

[Direct manual focus \(DMF\)](#)

Subject Recognition

[Focusing on human eyes](#)

[Subject Recog in AF \(still image/movie\)](#)

[Recognition Target \(still image/movie\)](#)

[Right/Left Eye Select \(still image/movie\)](#)

[Sbj Recog Frm Disp_ \(still image/movie\)](#)

[Face Memory](#)

[Regist. Faces Priority \(still image/movie\)](#)

Using focusing functions

[Focus Standard](#)

[Focus Area Limit \(still image/movie\)](#)

[Circ. of Focus Point \(still image/movie\)](#)

[Focus Area Color \(still image/movie\)](#)

[AF Area Auto Clear](#)

[AF-C Area Display](#)

[Phase Detect. Area](#)

[AF Transition Speed](#)

[AF Subj. Shift Sensitivity](#)

[AF/MF Selector](#)

[Pre-AF](#)

[Auto Magnifier in MF \(still image/movie\)](#)

[Focus Magnifier](#)

[Focus Magnif. Time \(still image/movie\)](#)

[Initial Focus Mag_ \(movie\)](#)

[Initial Focus Mag_ \(still image\)](#)

[Peaking Display](#)

Adjusting the exposure/metering modes

- [Exposure Comp. \(still image/movie\)](#)

- [Histogram display](#)

- [D-Range Optimizer \(still image/movie\)](#)

- [Metering Mode \(still image/movie\)](#)

- [Face Priority in Multi Metering \(still image/movie\)](#)

- [ND Filter \(still image/movie\)](#)

- [AE lock](#)

- [Auto Slow Shutter](#)

- [Zebra Display](#)

Selecting the ISO sensitivity

- [ISO \(still image/movie\)](#)

- [ISO AUTO Min. SS](#)

White balance

- [White Balance \(still image/movie\)](#)

- [Capturing a standard white color to set the white balance \(custom white balance\)](#)

- [Priority Set in AWB \(still image/movie\)](#)

- [Shutter AWB Lock](#)

Adding effects to images

- [Creative Look \(still image/movie\)](#)

- [Picture Profile \(still image/movie\)](#)

- [Soft Skin Effect \(still image/movie\)](#)

Shooting with drive modes (continuous shooting/self-timer)

- [Drive Mode](#)

- [Cont. Shooting](#)

- [Self-timer\(Single\)](#)

- [Self-timer\(Cont\)](#)

- [Cont. Bracket](#)

- [Single Bracket](#)

- [Indicator during bracket shooting](#)

[WB bracket](#)

[DRO Bracket](#)

[Bracket Settings](#)

[Self-timer \(movie\)](#)

[Interval Shoot Func.](#)

Setting the image quality and recording format

[File Format \(still image\)](#)

[JPEG Quality](#)

[JPEG Image Size](#)

[Aspect Ratio](#)

[Color Space](#)

[File Format \(movie\)](#)

[Movie Settings \(movie\)](#)

[S&Q Settings](#)

[Proxy Settings](#)

Using touch functions

[Touch Operation](#)

[Shooting Screen](#)

[Playback Screen](#)

[Menu Screen](#)

[Focusing using touch operations \(Touch Focus\)](#)

[Starting tracking with touch operations \(Touch Tracking\)](#)

[Shooting with touch operations \(Touch Shutter\)](#)

[Adjusting the exposure with touch operations \(Touch AE\)](#)

Shutter settings

[Silent Mode \(still image/movie\)](#)

[Release w/o Card](#)

Using the zoom

[The zoom features available with this product](#)

[Zoom](#)

[Zoom Range \(still image/movie\)](#)

[Zoom Speed](#)

[Step Zoom Magnif. \(still image/movie\)](#)

[About zoom scale](#)

Using the flash

[Using flash \(sold separately\)](#)

[Flash Mode](#)

[Flash Comp.](#)

[Exp.comp.set](#)

Reducing blur

[SteadyShot \(movie\)](#)

Noise reduction

[High ISO NR](#)

Setting the monitor display during shooting

[Auto Review \(still image\)](#)

[Grid Line Display \(still image/movie\)](#)

[Grid Line Type \(still image/movie\)](#)

[Live View Display](#)

[Bright Monitoring](#)

[Emphasized REC Display](#)

[Marker Display](#)

[Gamma Display Assist](#)

[Gamma Disp. Assist Typ.](#)

Recording movie audio

[Audio Recording](#)

[Audio Rec Level](#)

[Wind Noise Reduct.](#)

[Microphone Directivity](#)

[Mic Direct Select Setting](#)

TC/UB settings

- TC/UB
- TC/UB Disp. Setting

[Livestreaming video and audio \(USB Streaming\)](#)

Customizing the camera

[Contents of this chapter](#)

[Assigning frequently used functions to buttons \(Custom Key Setting\)](#)

Registering and recalling camera settings

- Camera Set. Memory
- Recalling registered shooting settings (Cam.Set)

Registering frequently used functions to the function menu

- Fn Menu Settings

Registering frequently used functions to My Menu

- Add Item
- Sort Item
- Delete Item
- Delete Page
- Delete All
- Display From My Menu

Recording movies by pressing the shutter button

- REC w/ Shutter (movie)

Monitor settings

- Monitor Flip Direction
- DISP (Screen Disp) Set

Viewing

[Contents of this chapter](#)

Viewing images

- Playing back still images
- Enlarging an image being played back (Enlarge Image)

- └ [Enlarge Initial Mag.](#)

- └ [Enlarge Initial Position](#)

- └ [Rotating recorded images automatically \(Display Rotation\)](#)

- └ [Playing back movies](#)

- └ [Volume Settings](#)

- └ [Playing back images using slideshow \(Slide Show\)](#)

- └ [Cont. Play for Interval](#)

- └ [Play Speed for Interval](#)

Changing how images are displayed

- └ [Playing back images on the image index screen \(Image Index\)](#)

- └ [Switching between still images and movies \(View Mode\)](#)

- └ [Display as Group](#)

- └ [Disp Specified Time Img.](#)

[Protecting recorded images \(Protect\)](#)

Adding information to images

- └ [Rating](#)

- └ [Rating Set \(Custom Key\)](#)

- └ [Rotating an image \(Rotate\)](#)

Extracting still images from a movie

- └ [Photo Capture](#)

Deleting images

- └ [Deleting multiple selected images \(Delete\)](#)

- └ [Delete pressing twice](#)

- └ [Delete confirm.](#)

Viewing images on a TV

- └ [Viewing images on a TV using an HDMI cable](#)

Changing the camera settings

Memory card settings

- └ [Format](#)

[Recover Image DB \(still image/movie\)](#)

[Display Media Info. \(still image/movie\)](#)

File settings

[File/Folder Settings](#)

[Select REC Folder](#)

[Create New Folder](#)

[File Settings](#)

[Write Serial Number \(still image/movie\)](#)

Network settings

[Display Wi-Fi Info.](#)

[SSID/PW Reset](#)

[Bluetooth Settings](#)

[Bluetooth Rmt Ctrl](#)

[Airplane Mode](#)

[Edit Device Name](#)

[Reset Network Set.](#)

Monitor settings

[Monitor Brightness](#)

Power settings

[Auto Monitor OFF \(still image\)](#)

[Power Save Start Time](#)

[Power OFF w/ monitor](#)

[Auto Power OFF Temp.](#)

USB settings

[USB Connection Mode](#)

[USB LUN Setting](#)

[USB Power Supply](#)

External output settings

[HDMI Resolution](#)

[HDMI Output Settings \(movie\)](#)

[HDMI Info. Display](#)

[CTRL FOR HDMI](#)

General settings

[Language](#)

[Area/Date/Time Setting](#)

[NTSC/PAL Selector](#)

[Audio signals](#)

[REC Lamp](#)

[Version](#)

[Privacy Notice](#)

[Screen Reader \(For some models only\)](#)

[Setting_Reset](#)

Functions available with a smartphone

[Functions available with a smartphone \(Creators' App\)](#)

[Pairing the camera with a smartphone \(Smartphone Connection\)](#)

Using a smartphone as a remote commander

[Using a smartphone as a remote commander](#)

[Remote Shoot Setting](#)

Transferring images to a Smartphone

[Select on Cam & Send \(transferring to a smartphone\)](#)

[Reset Transfer Status \(transferring to a smartphone\)](#)

Connecting while the camera is turned OFF

[Cnct. while Power OFF \(smartphone\)](#)

[Reading location information from a smartphone](#)

Using a computer

[Recommended computer environment](#)

Connecting/disconnecting the camera and a computer

[Connecting the camera to a computer](#)

[Disconnecting the camera from the computer](#)

Managing and editing images on a computer

[Introduction to computer software \(Imaging Edge Desktop/Catalyst\)](#)

[Importing images to the computer](#)

Operating the camera from a computer

[Operating the camera from a computer](#)

[Remote Shoot Setting](#)

[Livestreaming video and audio \(USB Streaming\)](#)

Appendix

[Battery life and number of recordable images](#)

[Number of recordable images](#)

[Recordable movie times](#)

List of icons on the monitor

[List of icons on the screen for shooting movies](#)

[List of icons on the screen for shooting still images](#)

[List of icons on the playback screen](#)

[Specifications](#)

[Trademarks](#)

[License](#)

If you have problems

[Troubleshooting](#)

[Self-diagnosis display](#)

[Warning messages](#)

How to use the “Help Guide”



The “Help Guide” is a “Web Instruction Manual” that has been designed to describe the functions and operating methods of this camera. Use the “Help Guide” to search for any information that you require in order to make full use of the camera.



(The “Help Guide” screens shown on this page are for reference only. They may differ from the actual on-screen display of your model.)



Hint

- The “Startup Guide” supplied with the camera describes basic operating methods and precautions for use. Please refer to the “Startup Guide” in combination with this “Help Guide.”

Icons used in the “Help Guide”

  : Menu items displayed in the still image shooting modes

  : Menu items displayed in the movie recording modes and slow-motion/quick-motion shooting modes

   : Menu items displayed in any of the still image shooting modes, movie recording modes, or slow-motion/quick-motion shooting modes

For details on the relationship between each shooting mode and the menu, refer to “[MENU button.](#)”

Finding your desired information

Method A: Searching by keyword

Enter a search keyword (“white balance,” “focus area,” etc.), and use the search results to display the description page that you want to view. If you enter two or more keywords by separating them with spaces (blanks), you can search for pages that contain all of those keywords.

Method B: Viewing the table of contents

Select a heading from the table of contents to display the description page.

Screen displayed on a computer



Screen displayed on a smartphone

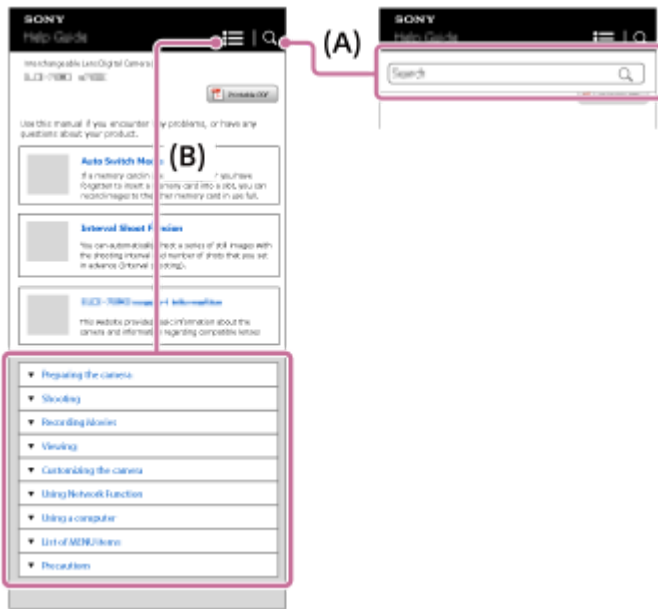

Method C: Finding functions from MENU

If you want to search for information while checking it against the MENU screen of the camera, use the “[Finding functions from MENU](#)” page. Select a MENU item from the list to go directly to the description page.



Viewing information about related features

“Related Topic” at the bottom of each page lists sections that contain information related to the description page currently being displayed. For a deeper understanding of the currently displayed page, refer to the listed sections as well.

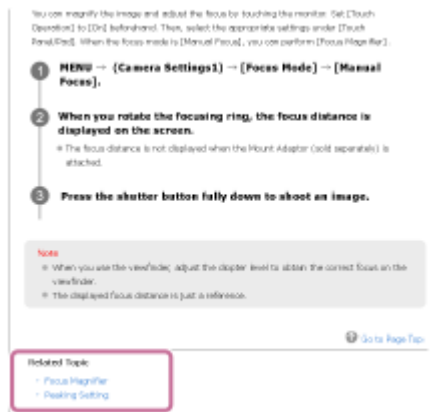

Printing all the pages of the “Help Guide”

To print all the pages, select the Printable PDF] button in the upper right corner of the top page. When the PDF file appears, use the printing menu of the browser to print it out.

This function is not available for certain languages.



Printing only the currently displayed page (only on a computer)

To print only the page currently being displayed, select the [ Print] button at the top of the page. When the printing screen appears, specify your printer.

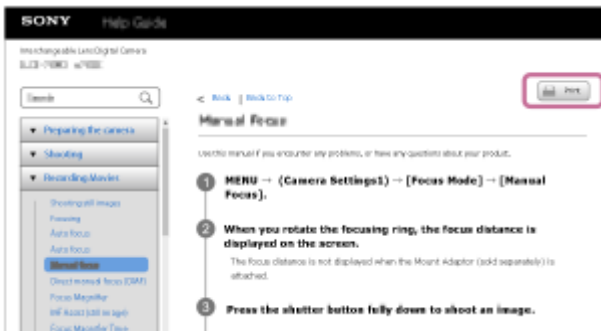

Precautions

Refer also to “Notes on use” in the Startup Guide (supplied) for this product.

We use environmentally conscious packaging materials

Environmentally conscious packaging materials were used for the camera and supplied accessories. Due to the characteristics of the packaging materials, note the following points.

- Powder, etc. from the packaging materials may adhere to the camera or supplied accessories. In this case, remove it with a commercially available blower or cleaning paper before use.
- The packaging materials will deteriorate with continuous use. Be careful when carrying the product by the packaging.

On the data specifications described in this manual

- The data on performance and specifications in this manual are based on an ordinary ambient temperature of 25°C (77°F), except where otherwise indicated.
- For the battery pack, the data are based on a battery pack that was fully charged until the charge lamp turned off.

On operating temperatures

- Shooting in extremely cold or hot environments that exceed the operating temperature range is not recommended.
- Under high ambient temperatures, the temperature of the camera rises quickly.
- When the temperature of the camera rises, the image quality may deteriorate. It is recommended that you wait until the temperature of the camera drops before continuing to shoot.
- Depending on the camera and battery temperature, the camera may become unable to record movies or the power may turn off automatically to protect the camera. A message will be displayed on the screen before the power turns off or you can no longer record movies. In this case, leave the power off and wait until the camera and battery temperature goes down. If you turn on the power without letting the camera and battery cool sufficiently, the power may turn off again, or you may still be unable to record movies.

Notes on recording for long periods of time or recording 4K movies

- During use, the camera and battery may become warm. This is not a malfunction.
- Especially during 4K shooting, the recording time may be shorter under low temperature conditions. Warm up the battery pack or replace it with a new battery.

Notes on playing movies on other devices

XAVC S movies can only be played back on compatible devices.

Notes on recording/playback

- Before you start recording, make a trial recording to make sure that the camera is working correctly.
- Playback of images recorded with your product on other equipment and playback of images recorded or edited with other equipment on your product are not guaranteed.
- Sony can provide no guarantees in the event of failure to record, or loss of or damage to recorded images or audio data, due to a malfunction of the camera or recording media, etc. We recommend backing up important data.
- Once you format the memory card, all the data recorded on the memory card will be deleted and cannot be restored. Before formatting, copy the data to a computer or other device.
- Attach the shoulder strap to the camera to prevent it from falling.
- When using this product with a tripod or grip, be sure to attach the camera securely.

Notes on using a tripod

Use a tripod with a screw less than 5.5 mm (7/32 inches) long. Otherwise, you cannot firmly secure the camera, and damage to the camera may occur.

Notes on handling memory cards

The temperature of memory cards may rise after saving. This is not a malfunction.

Backing up memory cards

Data may be corrupted in the following cases. Be sure to back up the data for protection.

- When the memory card is removed, the USB cable is disconnected, or the product is turned off in the middle of a read or write operation.
- When the memory card is used in locations subject to static electricity or electrical noise.

Database file error

- If you insert a memory card that does not contain an image database file into the product and turn on the power, the product automatically creates an image database file using some of the memory card's capacity. The process may take a long time and you cannot operate the product until the process is completed.
- If a database file error occurs, export all images to your computer, and then format the memory card using this product.

Do not use/store the product in the following places

- In an extremely hot, cold or humid place
In places such as in a car parked in the sun, the camera body may become deformed and this may cause a malfunction.
- Storing under direct sunlight or near a heater
The camera body may become discolored or deformed, and this may cause a malfunction.
- In a location subject to rocking vibration
It may cause malfunctions and an inability to record data. In addition, the recording media may become unusable, and recorded data may be corrupted.
- Near strong magnetic place
- In sandy or dusty places
Be careful not to let sand or dust get into the product. This may cause the product to malfunction, and in some cases this malfunction cannot be repaired.
- In places with high humidity
This may cause the lens to mold.
- In areas where strong radio waves or radiation are being emitted
Recording and playback may not function correctly.

On moisture condensation

- If the product is brought directly from a cold to a warm location, moisture may condense inside or outside the product. This moisture condensation may cause a malfunction of the product.
- To prevent moisture condensation when you bring the product directly from a cold to a warm location, first put it in a plastic bag and seal it to prevent air from entering. Wait for about an hour until the temperature of the product has reached the ambient temperature.
- If moisture condensation occurs, turn off the product and wait about an hour for the moisture to evaporate. Note that if you attempt to shoot with moisture remaining inside the lens, you will be unable to record clear images.

Precaution on carrying

- Do not hold, hit, or apply excessive force to the following parts, if your camera is equipped with them:
 - The lens part

- The movable monitor part
- The movable flash part
- The movable viewfinder part
- Do not carry the camera with the tripod attached. This may cause the tripod socket hole to break.
- Do not sit down in a chair or other place with the camera in the back pocket of your trousers or skirt, as this may cause malfunction or damage the camera.

Notes on handling the product

- This camera is not dustproof, drip-proof, or waterproof.
- Before you connect the cable to the terminal, be sure to check the orientation of the terminal. Then, insert the cable straight. Do not insert or remove the cable forcefully. This may cause the terminal part to break.
- The camera uses magnetic parts including magnets. Do not bring objects affected by magnetism, including credit cards and floppy disks, close to the camera.
- This camera is equipped with a magnetic sensor. The camera may turn on if it is placed too close to a magnet or a device with an internal magnet. Take care not to place the camera near any magnetic devices.
- The recorded image may be different from the image you monitored before recording.

On storing

- For lens-integrated cameras
Always attach the lens cap when you are not using the camera. (Only for models supplied with a lens cap)
- For interchangeable-lens cameras
Always attach the lens front cap or body cap when you are not using the camera. To prevent dust or debris from getting inside the camera, remove dust from the body cap before attaching it to the camera.
- If the camera is dirty after use, clean it. Water, sand, dust, salt, etc. left in the camera may cause a malfunction.

Notes on using lenses

- When using the power zoom lens, be careful not to get your fingers or any other objects caught in the lens. (Only for models with a power zoom feature or interchangeable lens cameras)
- If you must place the camera under a light source such as sunlight, attach the lens cap to the camera. (Only for models supplied with a lens cap or interchangeable lens cameras)
- If sunlight or a strong light source enters the camera through the lens, it may focus inside the camera and cause smoke or fire. When you shoot with backlighting, keep the sun sufficiently far away from the angle of view. Note that smoke or fire may occur even if the light source is slightly away from the angle of view.
- Do not directly expose the lens to beams such as laser beams. These may damage the image sensor and cause the camera to malfunction.
- If the subject is too close, the image may show any dust or fingerprints on the lens. Wipe the lens with a soft cloth, etc.

Notes on the flash (Only for models with a flash)

- Keep your fingers away from the flash. The light-emitting part may get hot.
- Remove any dirt from the surface of the flash. Dirt on the surface of the flash may emit smoke or burn due to heat generated by the emission of light. If there is dirt/dust, clean it off with a soft cloth.
- Restore the flash to its original position after using it. Make sure that the flash portion is not sticking up. (Only for models with a movable flash)

Notes on the Multi Interface Shoe (Only for models with a Multi Interface Shoe)

- When attaching or detaching accessories such as an external flash to the Multi Interface Shoe, first turn the power to OFF. When attaching the accessory, confirm that it is firmly fastened to the camera.
- Do not use the Multi Interface Shoe with a commercially available flash that applies voltages of 250 V or more or has the opposite polarity of the camera. It may cause a malfunction.

Notes on the viewfinder and flash (Only for models with a viewfinder or a flash)

- Take care that your finger is not in the way when pushing the viewfinder or flash down. (Only for models with a movable viewfinder or a movable flash)
- If water, dust or sand adheres to the viewfinder or flash unit, it may cause a malfunction. (Only for models with a movable viewfinder or a movable flash)

Notes on the viewfinder (Only for models with a viewfinder)

- When shooting with the viewfinder, you may experience symptoms such as eyestrain, fatigue, travel sickness, or nausea. We recommend that you take a break at regular intervals when you are shooting with the viewfinder. In case you may feel uncomfortable, refrain from using the viewfinder until your condition recovers, and consult your doctor if necessary.
- Although the viewfinder is built with high-precision technology for 99.99% or more effective pixels, black dots may appear, and white, red, blue, and green dots may not disappear. This is not a malfunction. These dots are not recorded.
- Do not forcibly push down the viewfinder when the eyepiece is pulled out. It may cause a malfunction. (Only for models with a movable viewfinder and an eyepiece that can be pulled out)
- If you pan the camera while looking into the viewfinder or move your eyes around, the image in the viewfinder may be distorted or the color of the image may change. This is a characteristic of the lens or display device and is not a malfunction. When you shoot an image, we recommend that you look at the center area of the viewfinder.
- The image may be slightly distorted near the corners of the viewfinder. This is not a malfunction. When you want to see the full composition with all its details, you can also use the monitor.
- If you use the camera in a cold location, the image may have a trailing appearance. This is not a malfunction.
- Do not directly expose the viewfinder to beams such as laser beams. These may damage the inside of the viewfinder and cause the camera to malfunction.

Notes on the monitor

- Although the monitor is built with high-precision technology for 99.99% or more effective pixels, black dots may appear, and white, red, blue, and green dots may not disappear. This is not a malfunction. These dots are not recorded.
- Do not press against the monitor. The monitor may be discolored and that may cause a malfunction.
- If the monitor has drops of water or other liquids on it, wipe it with a soft cloth. If the monitor stays wet, the surface of the monitor may change or deteriorate. This may cause a malfunction.
- If you use the camera in a cold location, the image may have a trailing appearance. This is not a malfunction.
- When you connect cables to the terminals on the camera, the rotating range of the monitor may become limited.

Notes on the image sensor

If you point the camera at an extremely strong light source while shooting images with a low ISO sensitivity, highlighted areas in the images may be recorded as black areas.

Notes on the wind screen (Only for models supplied with a wind screen)

- If the wind screen is stored for a long time in a place exposed to direct sunlight or near a heating device, it may become discolored. The texture and degree of raising of the hairs may change depending on the environment during use and storage as well as aging.
- Brushing or forcefully pulling the hairs on the wind screen may cause them to come off.
- If the wind screen gets wet or dirty, do not remove it from the wind screen adaptor. Wipe it off with a soft, dry cloth and dry it in the shade.

On image data compatibility

This product conforms with DCF (Design rule for Camera File system) universal standard established by JEITA (Japan Electronics and Information Technology Industries Association).

Services and software provided by other companies

Network services, content, and the [operating system and] software of this Product may be subject to individual terms and conditions and changed, interrupted or discontinued at any time and may require fees, registration and credit card

information.

Notes on connecting to the internet

To connect the camera to a network, connect it through a router or a LAN port with the same function. Failure to connect in this manner may result in security issues.

Notes on security

- SONY WILL NOT BE HELD LIABLE FOR DAMAGES OF ANY KIND RESULTING FROM FAILURE TO IMPLEMENT PROPER SECURITY MEASURES ON TRANSMISSION DEVICES, UNAVOIDABLE DATA LEAKS CAUSED BY TRANSMISSION SPECIFICATIONS, OR OTHER SECURITY PROBLEMS.
- Depending on the usage environment, unauthorized third parties on the network may be able to access the product. When connecting the camera to a network, be sure to confirm that the network is protected securely.
- The content of communications may be unknowingly intercepted by unauthorized third parties in the vicinity of the signals. When using wireless LAN communication, implement proper security measures to protect the content of communications.

Optional accessories

- It is recommended that you use genuine Sony accessories.
- Some Sony accessories are only available in certain countries and regions.

Available models and kits

Some models and kits are only available in certain countries and regions.

5-049-603-11(1) Copyright 2023 Sony Corporation

Lending, transferring or discarding the camera and/or memory card to others (Notes on protecting private information)

Important information may be recorded on the camera and/or memory card depending on the functions and camera settings.

Before lending, transferring, or discarding the camera and/or memory card to others, be sure to read the following and make sure that you have completed the procedures.

Notes on lending, transferring, or discarding the camera and/or memory card to others

Before lending, transferring, or discarding the camera to others, be sure to perform the following operation to protect private information.

- Select [Setting Reset] → [Initialize].

Notes on lending, transferring, or discarding a memory card to others

Executing [Format] or [Delete] on the camera or a computer may not completely delete the data on the memory card. Before lending or transferring a memory card to others, we recommend that you delete any data on it completely using data deletion software. When discarding a memory card, we recommend that you physically destroy it.

Notes on network functions

When you use network functions, unintended third parties on the network may access the camera, depending on the usage environment. For example, unauthorized access to the camera may occur in network environments to which another network device is connected or can connect without permission. Sony bears no responsibility for any loss or damage caused by connecting to such network environments.

Notes on location information

If you upload and share still images or movies taken with this camera on the Internet while the location information is linked with the dedicated smartphone application, you may accidentally reveal the location information to a third party. To prevent third parties from obtaining your location information, deactivate the [Location Information Linkage] function of the dedicated application.

Warning on copyrights

Television programs, films, videotapes, and other materials may be copyrighted. Unauthorized recording of such materials may be contrary to the provisions of the copyright laws.

Notes on the battery pack and charging the battery

Notes on using the battery pack

- Be sure to use only genuine Sony brand battery packs.
- The correct remaining battery indicator may not be displayed under some operating or environmental conditions.
- Do not expose the battery pack to water. The battery pack is not water-resistant.
- Do not leave the battery pack in extremely hot places, such as in a car or under direct sunlight.

Notes on charging the battery pack

- Charge the battery pack (supplied) before using the product for the first time.
- The charged battery pack will discharge little by little even if you do not use it. Charge the battery pack each time before you use the product so that you do not miss any opportunities to shoot images.
- Do not charge battery packs except battery packs specified for this product. Doing so can result in leaks, overheating, explosions, electric shocks, burns, or injuries.
- When you use a completely new battery pack or a battery pack that has not been used for a long time, the charge lamp (CHARGE) may flash quickly when the battery is charged. If this happens, remove the battery pack and then re-insert it to recharge.
- We recommend charging the battery pack in an ambient temperature of between 10 °C and 30 °C (50 °F and 86 °F). The battery pack may not be correctly charged in temperatures outside this range.
- Operation cannot be guaranteed with all external power supplies.
- When charging is finished, disconnect the AC Adaptor from the wall outlet (wall socket) or disconnect the USB cable from the camera. Not doing so may result in a shorter battery life.
- Do not continuously or repeatedly charge the battery pack without using it if it is already fully charged or close to fully charged. Doing so may cause a deterioration in battery performance.
- If the product's charge lamp flashes while charging, remove the battery pack being charged, and then insert the same battery pack firmly back into the product. If the charge lamp flashes again, this may indicate a faulty battery or that a battery pack other than the specified type has been inserted. Check that the battery pack is the specified type. If the battery pack is the specified type, remove the battery pack, replace it with a new or different one and check that the newly inserted battery is charging correctly. If the newly inserted battery is charging correctly, the previously inserted battery may be faulty.
- If the charge lamp flashes while charging the battery pack inside the camera, this indicates that charging has stopped temporarily and is on standby. Charging stops and enters standby status automatically when the temperature is outside of the recommended operating temperature. When the temperature returns to the appropriate range, charging resumes and the charge lamp lights up again.

Remaining battery indicator

- The remaining battery indicator appears on the screen. It takes about one minute for the correct remaining battery indicator to appear.
- The correct remaining battery indicator may not be displayed under some operating or environmental conditions.
- If you do not operate the product for a certain period of time while the power is on, the product turns off automatically (Auto power-off function).
- If the remaining battery indicator does not appear on the screen, press the DISP (Display Setting) button to display it.

Effective use of the battery pack

- Battery performance decreases in low temperature environments. So in cold places, the operational time of the battery pack is shorter. To ensure longer battery pack use, we recommend putting the battery pack in your pocket

close to your body to warm it up, and insert it in the product immediately before you start shooting. If there are any metal objects such as keys in your pocket, be careful of causing a short-circuit.

- The battery pack will run down quickly if you use the flash or continuous shooting function frequently, turn the power on/off frequently, or set the monitor very bright.
- We recommend preparing spare battery packs and taking trial shots before taking the actual shots.
- If the battery terminal is dirty, you may not be able to turn on the product or the battery pack may not be properly charged. In that case, clean the battery by lightly wiping off any dust using a soft cloth or a cotton swab.

How to store the battery pack

To maintain the battery pack's function, charge the battery pack and then fully discharge it in the camera at least once a year before storing it. Store the battery in a cool, dry place after removing it from the camera.

On battery life

- The battery life is limited. If you use the same battery repeatedly, or use the same battery for a long period, the battery capacity decreases gradually. If the available time of the battery is shortened significantly, it is probably time to replace the battery pack with a new one.
- The battery life varies according to how the battery pack is stored and the operating conditions and environment in which each battery pack is used.

Notes on memory card

- If  (overheating warning icon) is displayed on the monitor, do not remove the memory card from the camera right away. Instead, wait for a while after turning off the camera, and then remove the memory card. If you touch the memory card while it is hot, you may drop it and the memory card may be damaged. Be careful when removing the memory card.
- If you repeatedly shoot and delete images for a long time, fragmentation of data in a file in the memory card may occur, and movie recording may be interrupted in the middle of shooting. If this happens, save your images to a computer or other storage location, then execute [Format] using this camera.
- Do not remove the battery pack or the memory card, disconnect the USB cable, or turn the camera off while the access lamp is lit up. This may cause the data on the memory card to become damaged.
- Be sure to back up the data for protection.
- Not all memory cards are guaranteed to operate correctly.
- Images recorded on an SDXC memory card cannot be imported to or played on computers or AV devices not compatible with exFAT when connected using a USB cable. Make sure that the device is compatible with exFAT before connecting it to the camera. If you connect your camera to an incompatible device, you may be prompted to format the card. Never format the card in response to this prompt, as doing so will erase all data on the card. (exFAT is the file system used on SDXC memory cards.)
- Do not expose the memory card to water.
- Do not strike, bend or drop the memory card.
- Do not use or store the memory card under the following conditions:
 - High temperature locations such as in a car parked under the sun
 - Locations exposed to direct sunlight
 - Humid locations or locations with corrosive substances present
- If the memory card is used near areas with strong magnetization, or used in locations subject to static electricity or electrical noise, the data on the memory card may become damaged.
- Do not touch the terminal section of the memory card with your hand or a metal object.
- Do not leave the memory card within the reach of small children. They might accidentally swallow it.
- Do not disassemble or modify the memory card.
- The memory card may be hot just after it has been used for a long time. Be careful when you handle it.
- Memory card formatted with a computer is not guaranteed to operate with the product. Be sure to format the memory card using this product.
- Data read/write speeds differ depending on the combination of the memory card and the equipment used.
- Do not press down hard when writing in the memo space on the memory card.
- Do not attach a label on the memory card itself nor on a memory card adaptor. You may not be able to remove the memory card.
- If the write-protect switch or delete-protect switch of an SD memory card is set to the LOCK position, you cannot record or delete images. In this case, set the switch to the record position.
- To use a Memory Stick Micro media or microSD memory card with this product:
 - Be sure to insert the memory card into a dedicated adaptor. If you insert a memory card into the product without a memory card adaptor, you might not be able to remove it from the product.
 - When inserting a memory card into a memory card adaptor, be sure that the memory card is inserted in the correct direction and then insert it as far as it will go. If the card is not inserted properly, it may result in a malfunction.
- About Memory Stick PRO Duo media and Memory Stick PRO-HG Duo media:
 - This Memory Stick is equipped with MagicGate function. MagicGate is copyright protection technology that uses encryption technology. Data recording/playback that requires MagicGate functions cannot be performed with this product.

- High-speed data transfer using a parallel interface is supported.

Related Topic

- [Format](#)

5-049-603-11(1) Copyright 2023 Sony Corporation

Digital Camera
ZV-1M2

On cleaning

Cleaning the lens

- Do not use a cleaning solution containing organic solvents, such as thinner, or benzine.
- When cleaning the lens surface, remove dust with a commercially available blower. In case of dust that sticks to the surface, wipe it off with a soft cloth or tissue paper slightly moistened with lens cleaning solution. Wipe in a spiral pattern from the center to the outside. Do not spray lens cleaning solution directly onto the lens surface.

Cleaning the product surface

Clean the product surface with a soft cloth slightly moistened with water, then wipe the surface with a dry cloth. To prevent damage to the finish or casing:

- Do not expose the product to chemical products such as thinner, benzine, alcohol, disposable cloths, insect repellent, sunscreen or insecticide.
- Do not touch the product with any of the above on your hand.
- Do not leave the product in contact with rubber or vinyl for a long time.

Cleaning the monitor

- If you wipe the monitor firmly using tissue paper, etc., the monitor may be scratched.
- If the monitor becomes dirty with fingerprints or dust, gently remove the dust from the surface, and then clean the monitor using soft cloth, etc.

Digital Camera
ZV-1M2

Checking the camera and the supplied items

The number in parentheses indicates the number of pieces.

- Camera (1)
- NP-BX1 Rechargeable Battery Pack (1)

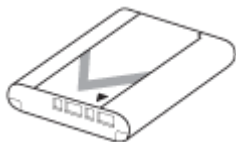



- Wind screen (1) (Attached to the wind screen adaptor)

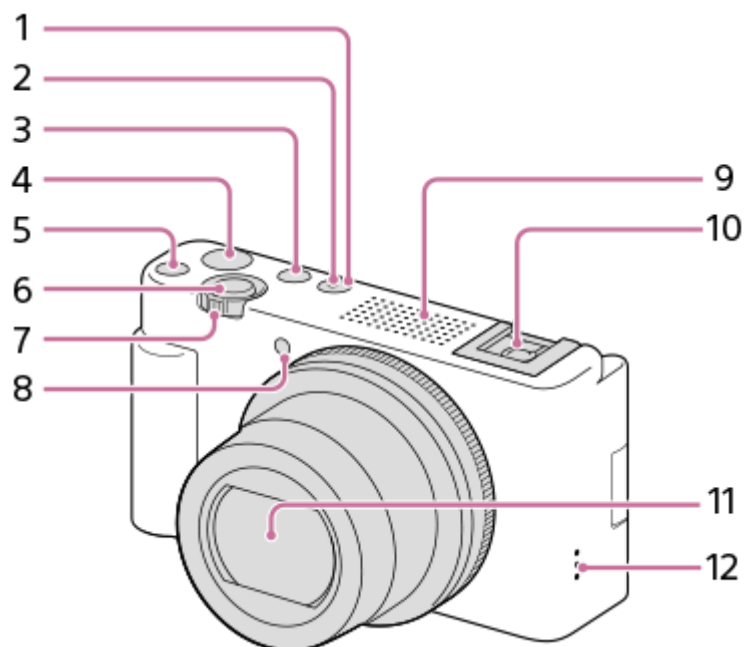

- Wind screen adaptor (1)
- Startup Guide (1)
- Reference Guide (1)

Identifying parts



1. ON/OFF (Power) button
2. Power/Charge lamp
3. Still/Movie/S&Q button
4. MOVIE (Movie) button
5. C1 button (Custom button 1) /  (Background Defocus) button
6. Shutter button
7. For shooting: W/T (zoom) lever
For viewing:  (Index) lever/Playback zoom lever
8. Self-timer lamp/Recording lamp
9. Internal microphone

- Do not cover this part during movie recording. Doing so may cause noise or lower the volume.

10. Multi Interface Shoe

- Some accessories may not go in all the way and protrude backward from the Multi interface shoe. However, when the accessory reaches the front end of the shoe, the connection is completed.
- For details on compatible accessories for the Multi Interface Shoe, visit the Sony website, or consult your Sony dealer or local authorized Sony service facility.
Accessories for the Accessory Shoe can also be used. Operations with other manufacturers' accessories are not guaranteed.



11. Lens
12. Speaker

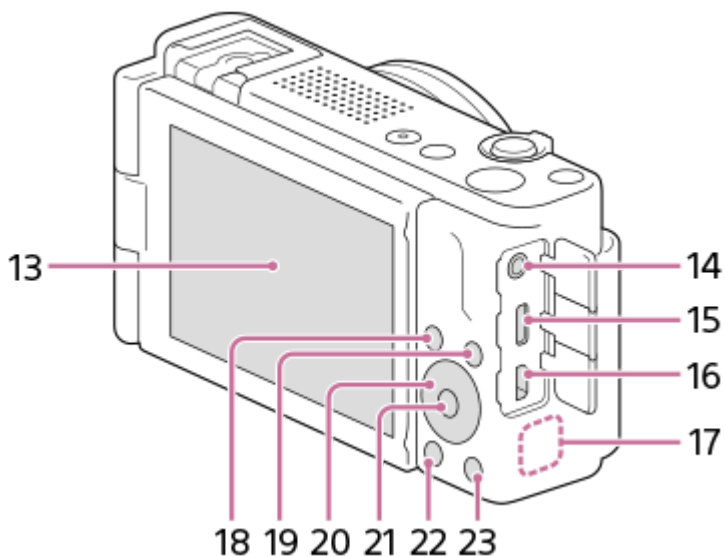

13. Monitor/Touch panel

- You can adjust the monitor to an easily viewable angle and shoot from any position.

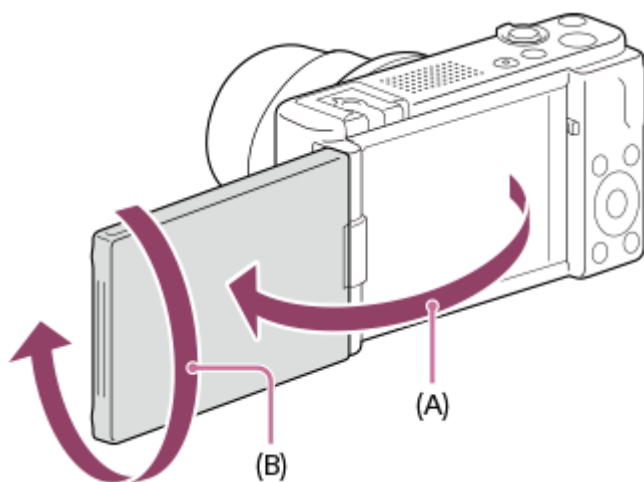

(A): Approx. 176°

(B): Approx. 270°

- If you open the monitor from the closed position with the screen facing inwards, the camera will turn on.
- To choose whether or not the camera turns off when the monitor is closed with the screen facing inwards, select MENU → (Setup) → [Power Setting Option] → [Power OFF w/ monitor].
- You may not be able to adjust the monitor angle depending on the type of a tripod you use. In such a case, release the tripod screw once to adjust the monitor angle.
- Do not apply excessive force when opening, closing, or rotating the monitor. Doing so may cause a malfunction.

14. (Microphone) jack

- When an external microphone is connected, the built-in microphone turns off automatically. When the external microphone is a plugin-power type, the power of the microphone is supplied by the camera.

15. USB Type-C terminal

16. HDMI micro jack

17. Wi-Fi/Bluetooth antenna (built-in)

18. For shooting: Fn (Function) button

For viewing: (Send to Smartphone) button

19. MENU button

20. Control wheel

21. Center button

22. (Playback) button

23. (Delete) button/ (Product Showcase Set) button

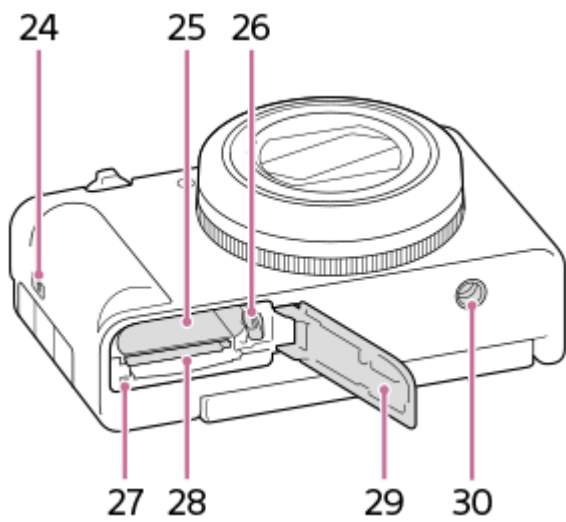

- 24. Hook for strap
 - 25. Battery insertion slot
 - 26. Battery lock lever
 - 27. Access lamp
 - 28. Memory card slot
 - 29. Battery/Memory card cover
 - 30. Tripod socket hole
- Supports 1/4-20 UNC screws

- Use a tripod with a screw less than 5.5 mm (7/32 inches) long. Otherwise, you cannot firmly secure the camera, and damage to the camera may occur.

Using the wind screen (supplied)

Use the wind screen by attaching it to the Multi Interface Shoe to reduce wind noise picked up by the internal microphone when recording movies.

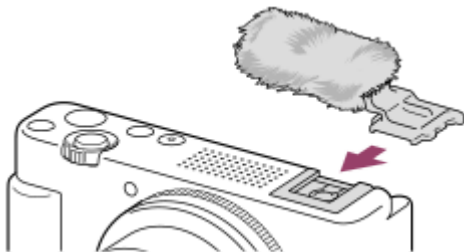

Note

- When attaching the wind screen, make sure that the wind screen does not get caught in the Multi Interface Shoe.

Basic icons displayed on the monitor

This section describes the screen display when the shooting mode is **P** (Program Auto).

- The following is an example of the display when [DISP (Screen Disp) Set] is set to [Display All Info.] and the touch function icons are hidden.
- The displayed content and positions are for reference only, and may differ from the actual display. Some icons may not be displayed depending on the camera settings.

During movie recording

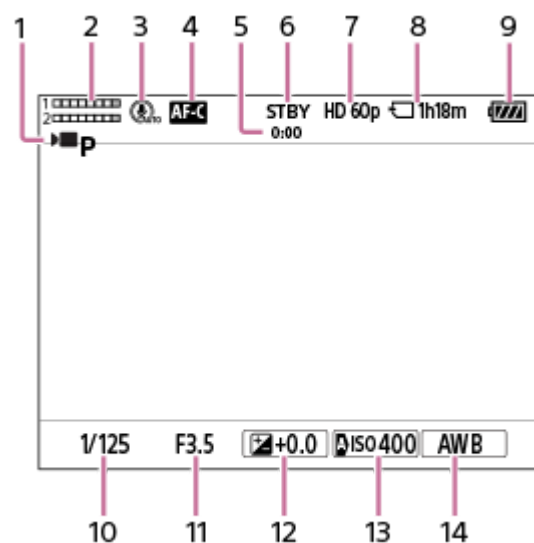

1. [▶ Shoot Mode] is set to ▶ **P** [Program Auto].
2. Audio level
3. [Microphone Directivity] is set to [Auto].
4. [Focus Mode] is set to [Continuous AF].
5. Actual shooting time of the movie
6. The camera is in the shooting standby mode.
7. [File Format] is set to [XAVC S HD] and [Rec Frame Rate] is set to [60p].
8. Recordable movie time on the memory card
9. Remaining battery level
10. Shutter speed
11. Aperture value
12. Exposure compensation
13. [ISO] is set to [ISO AUTO]. (The ISO value automatically set by the camera is displayed.)
14. [White Balance] is set to [Auto].

During still image shooting

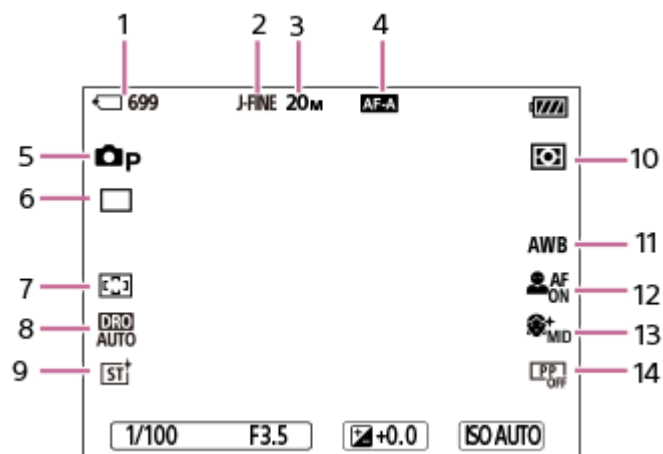

1. Number of still images that can be recorded on the memory card
2. [JPEG Quality] is set to [Fine].
3. [JPEG Image Size] is set to [L: 20M].
4. [Focus Mode] is set to [Automatic AF].
5. [Shoot Mode] is set to [Program Auto].
6. [Drive Mode] is set to [Single Shooting].
7. [Focus Area] is set to [Wide].
8. [D-Range Optimizer: Auto] is selected.
9. [Creative Look] is set to [ST].
10. [Metering Mode] is set to [Multi].
11. [White Balance] is set to [Auto].
12. [Subject Recog in AF] is set to [On] and [Recognition Target] is set to [Human].
13. [Soft Skin Effect] is set to [On: Mid].
14. [Picture Profile] is set to [Off].

Related Topic

- [List of icons on the screen for shooting movies](#)
- [List of icons on the screen for shooting still images](#)
- [List of icons on the playback screen](#)

Touch panel

By touching the monitor, you can intuitively perform operations such as focusing on the shooting screen and operating the playback screen.

Touch operations (on the shooting screen)

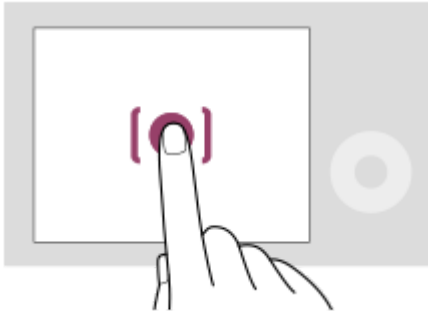

Touch the monitor to specify where to focus (Touch Focus).

Touch a subject on the monitor to use the touch tracking function (Touch Tracking).

You can also focus on a subject and shoot images simply by touching the subject on the screen (Touch Shutter).

When you touch the subject on the screen, the camera adjusts the brightness automatically according to the subject (Touch AE). [Touch AE] can also be used in combination with [Touch Focus], [Touch Tracking], or [Touch Shutter].

For information on how to switch the function activated by touch operation, refer to “ [Shooting Screen](#) .”

Touch operations (on the playback screen)

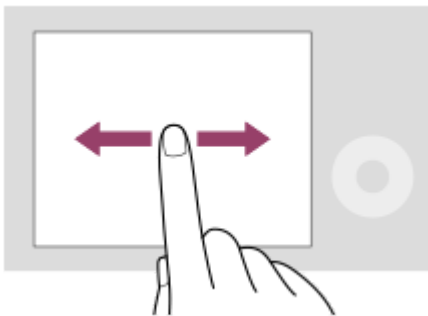

During single-image playback, swipe the screen to the left or right to move to the previous or next image.

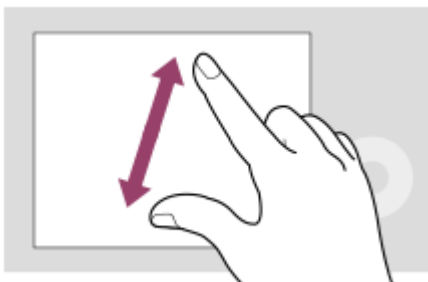

During single-image playback, you can enlarge or reduce the displayed image by moving apart or bringing together two fingers on the screen (pinch-out/pinch-in).

- You can also double-tap the monitor to enlarge a still image or exit the enlarged image.
- During movie playback, you can start or pause playback using touch operations.

Hint

- You can also operate the camera by touching the guides displayed on the bottom of the screen (Except when in the [Intelligent Auto] mode).
- You can open the function menu by swiping upward quickly on the shooting screen. You can show and hide the icons for functions displayed on the left and right sides of the screen by swiping left and right quickly on the shooting screen.
- You can set whether to enable touch operations and configure detailed settings under [Shooting Screen], [Playback Screen], and [Menu Screen].

Related Topic

- [Touch Operation](#)
- [Shooting Screen](#)
- [Playback Screen](#)
- [Menu Screen](#)
- [Touch function icons](#)
- [Focusing using touch operations \(Touch Focus\)](#)
- [Starting tracking with touch operations \(Touch Tracking\)](#)
- [Shooting with touch operations \(Touch Shutter\)](#)
- [Adjusting the exposure with touch operations \(Touch AE\)](#)

Touch function icons

Some functions have icons for touch operations (touch function icons). You can execute or change the settings of the functions by touching the icons.

Settings for using the touch function icons

- [Touch Operation]: [On]
- [Shooting Screen]:
 - Set [Shooting Screen] to [On].
 - [Swipe Right] or [Swipe Left] → desired setting.

To show/hide the touch function icons

Swipe right or left on the shooting standby screen. The touch function icons will appear on the left and right sides of the screen according to the settings for [Swipe Right] and [Swipe Left] under [Shooting Screen].

To hide the touch function icons, swipe the screen in the opposite direction from when you made the icons appear.

Examples of the touch function icon display and functions of each icon

The examples show the display when you set the icons to appear on both the left and right sides.

During movie recording

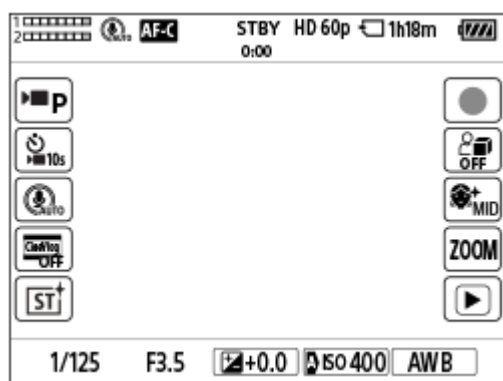

Icons on the left side: Shoot Mode, Self-timer, Mic Directivity Select, Cinematic Vlog Set., Creative Look*

Icons on the right side: Starts recording movies, Product SC Set, Soft Skin Effect, Step Zoom, switches to the playback screen**

* When the shooting mode is set to [Intelligent Auto], the icon changes to the (image adjustment) setting icon.

** The shot mark button is displayed during movie recording so that shot marks can be set for the movie being recorded.

During still image shooting

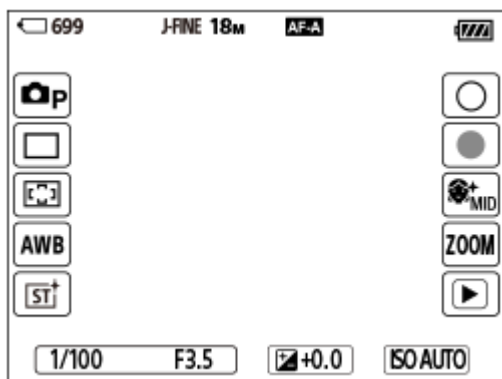

Icons on the left side: Shoot Mode, Drive Mode, Focus Area, White Balance, Creative Look*

Icons on the right side: Shoots a still image, starts recording movies, Soft Skin Effect, Step Zoom, switches to the playback screen**

* When the shooting mode is set to [Intelligent Auto], the icon changes to the (image adjustment) setting icon.

** The shot mark button is displayed even during movie recording in the still image shooting mode so that shot marks can be set for the movie being recorded.

Hint

- When MENU → (Setup) → [Touch Operation] → [Playback Screen] is set to [On], the touch function icons on the playback screen are always displayed.
- If you set MENU → (Setup) → [Touch Operation] → [Shooting Screen] → [Icon When Monitor Flipped] to [Flip], you can set whether to switch the left and right icons on the shooting screen when the monitor is flipped.

Related Topic





- [Shooting Screen](#)
- [Shoot Mode \(still image\)/Shoot Mode \(movie\)/Shoot Mode \(S&Q\)](#)
- [Self-timer \(movie\)](#)
- [Microphone Directivity](#)
- [Cinematic Vlog Set.](#)
- [Creative Look \(still image/movie\)](#)
- [Adjusting images in the auto mode \(My Image Style\)](#)
- [Shooting movies \(Intelligent Auto\)](#)
- [Product Showcase Set](#)
- [Soft Skin Effect \(still image/movie\)](#)
- [Step Zoom Magnif. \(still image/movie\)](#)
- [Playing back movies](#)
- [Drive Mode](#)
- [Selecting the focus area \(Focus Area\)](#)
- [White Balance \(still image/movie\)](#)
- [Shooting still images \(Intelligent Auto\)](#)
- [Playing back still images](#)

Digital Camera
ZV-1M2

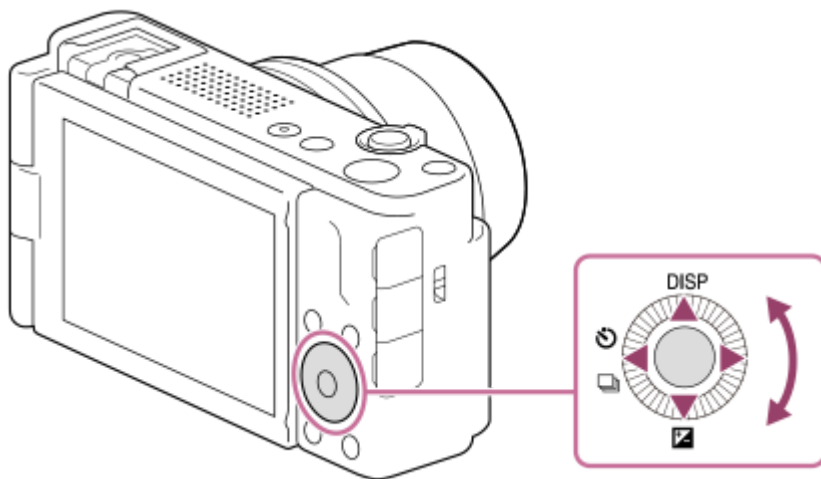
Control wheel

On the menu screen or the screen displayed by pressing the Fn button, you can move the selection frame by turning the control wheel or by pressing the top/bottom/left/right side of the control wheel. Your selection is confirmed when you press the center of the control wheel.



- The DISP (Display Setting),  ( Exposure Comp.), and  /  ( Self-timer/Drive Mode) functions are assigned to the top/bottom/left side of the control wheel. In addition, you can assign selected functions to the left/right side and the center of the control wheel.
- During playback, you can display the next/previous image by pressing the right/left side of the control wheel or by turning the control wheel.

Related Topic

- [Assigning frequently used functions to buttons \(Custom Key Setting\)](#)

Digital Camera
ZV-1M2

Still/Movie/S&Q button

You can use the Still/Movie/S&Q button **(A)** to select a shooting mode.

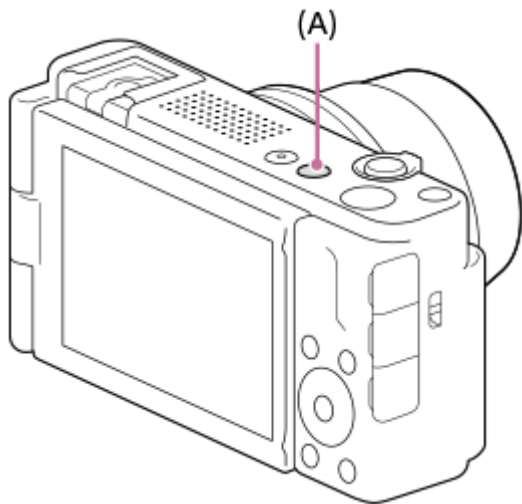

Each time you press the Still/Movie/S&Q button, the shooting mode switches in the order of still image shooting mode, movie recording mode, and slow-motion/quick-motion recording mode.

Hint

- The menu items displayed in the [Shooting], [Exposure/Color], and [Focus] tabs of the menu screen vary depending on the shooting mode (still image/movie/S&Q). Before you adjust these settings, select the desired shooting mode with the Still/Movie/S&Q button.

Related Topic

- [MENU button](#)
- [Shooting movies \(Intelligent Auto\)](#)
- [Shooting still images \(Intelligent Auto\)](#)
- [S&Q Settings](#)

MENU button

The menu screen is displayed by pressing the MENU button. You can change settings related to all of the camera operations including shooting and playback, or you can execute a function from the menu screen.

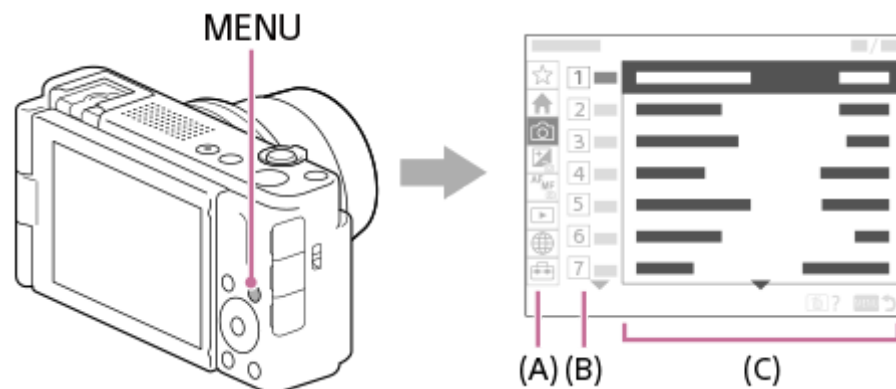

(A) Menu tab

Menu tabs are categorized by usage scenario, such as shooting, playback, network settings, etc.

(B) Menu group

In each tab, menu items are grouped by function.

The number assigned to the group is the serial number in the tab. Refer to the number to determine the location of the group in use.

(C) Menu item

Select the function you want to set or execute.

Hint

- The name of the selected tab or group is displayed at the top of the screen.
- When [Touch Operation] is set to [On] and [Menu Screen] is set to [On], touch operations on the menu screen are possible.

Basic operations on the menu screen

1. Press the MENU button to display the menu screen.
2. Move within the menu tree and find the desired menu item by pressing the top/bottom/left/right side of the control wheel.
 - The displayed menu items differ between the still image shooting modes and movie recording modes.

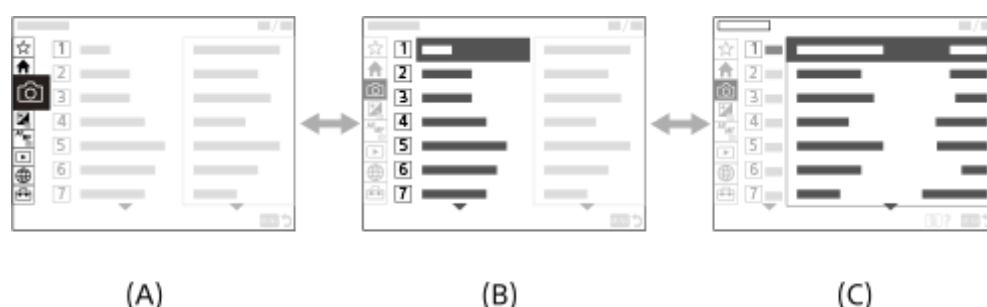

- (A) Menu tabs
- (B) Menu groups
- (C) Menu items

3. Press the center of the control wheel to select the menu item.

The setting screen or execution screen for the selected item will appear on the monitor.

4. Select a parameter or execute the function.

- If you want to cancel changing the parameter, press the MENU button and go back to the previous screen.

5. Press the MENU button to exit the menu screen.

You will return to the shooting screen or playback screen.

Hint

- In the  (Main) tab, you can view a list of the current shooting settings. Select a setting value in the tab to open the corresponding menu item and change the setting value.

Relationship between the shooting mode and menu screen

The menu groups and menu items displayed in the [Main], [Shooting], [Exposure/Color], and [Focus] tabs vary depending on the shooting mode.

Still image shooting modes

- Menu items for shooting still images are displayed.*

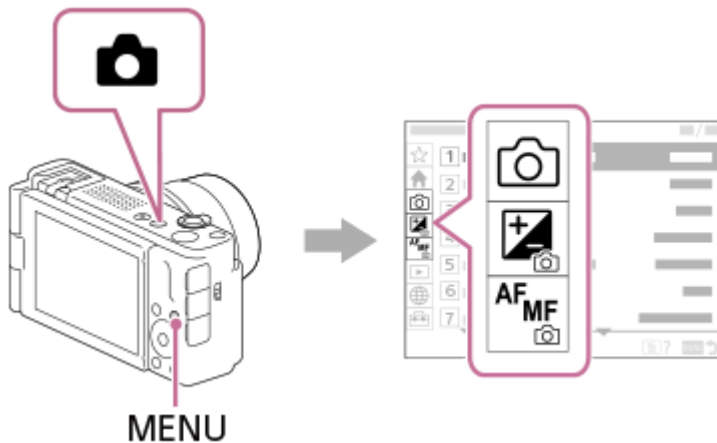





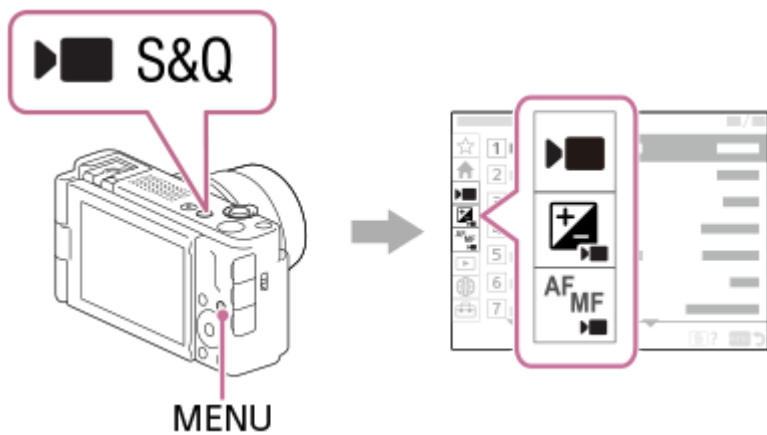

* Since you can record movies with the MOVIE (Movie) button even in the still image shooting mode, some basic movie menu items are also displayed.

Movie recording modes/Slow-motion and quick-motion shooting modes

- Menu items for recording movies are displayed.



Icons used in the “Help Guide”

-   S&Q : Menu items displayed in the still image shooting modes
-   S&Q : Menu items displayed in the movie recording modes and slow-motion/quick-motion shooting modes
-   S&Q : Menu items displayed in any of the still image shooting modes, movie recording modes, or slow-motion/quick-motion shooting modes

Related Topic

- [Add Item](#)
- [Display From My Menu](#)
- [Assigning frequently used functions to buttons \(Custom Key Setting\)](#)
- [Still/Movie/S&Q button](#)
- [Main menu \(shooting setting list\)](#)

Main menu (shooting setting list)

Select the  (Main) tab on the menu screen to display a list of shooting settings. You can confirm the settings before shooting or for each scene, and also change the settings directly from this screen.

Main menu for shooting movies

Main 1

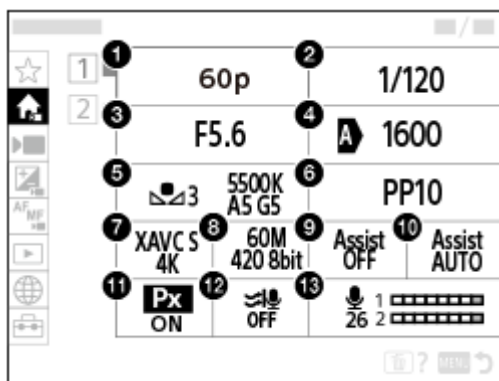

1. Rec Frame Rate/ **S&Q** S&Q Settings (when shooting slow-motion/quick-motion movies)
2. Shutter Speed
3. Aperture
4. ISO
5. White Balance
6. Picture Profile
7.  File Format
8. Record Setting/ **S&Q** Record Setting (when shooting slow-motion/quick-motion movies)
9. Gamma Display Assist
10. Gamma Disp. Assist Typ.
11. **Px** Proxy Recording
12. Wind Noise Reduct.
13. Audio Rec Level

Main 2

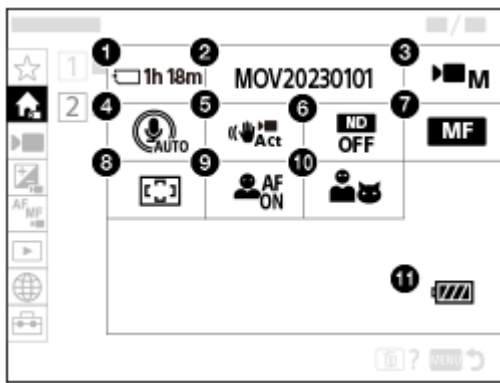



1. Format
2. File Settings
3. Shoot Mode
4. Microphone Directivity
5. SteadyShot
6. ND Filter
7. Focus Mode
8. Focus Area
9. Subject Recog in AF
10. Recognition Target
11. Remaining battery level

Main menu for shooting still images

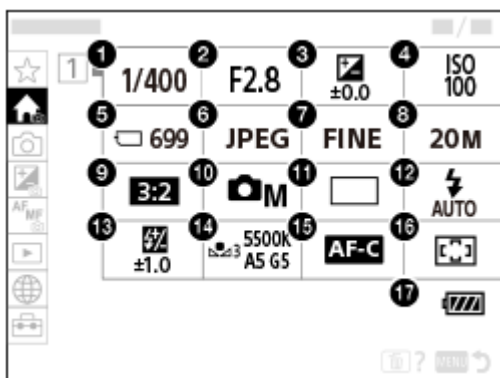
Main 1



1. Shutter Speed *
2. Aperture *
3. Exposure Comp.
4. ISO
5. Format
6. File Format

7. JPEG Quality
8. JPEG Image Size
9. Aspect Ratio
10.  Shoot Mode
11. Drive Mode
12. Flash Mode
13. Flash Comp.
14. White Balance
15. Focus Mode
16.  Focus Area

17. Remaining battery level

* When the shooting mode is [Program Auto], the shutter speed and aperture value are displayed in the same area. You can perform Program Shift by selecting the area.

Hint

- If you assign the [Display Main Menu] function to the desired key using the custom key settings, you can also open the Main menu by pressing the assigned key.
- You can open the setting screens by touching the icons on the main menu when [Touch Operation] is set to [On] and [Menu Screen] is set to [On].

Related Topic

- [MENU button](#)
- [Assigning frequently used functions to buttons \(Custom Key Setting\)](#)
- [Touch Operation](#)
- [Menu Screen](#)

Fn (function) button

If you press the Fn (function) button during shooting, a menu containing frequently used functions such as the audio recording level and focus mode will appear on the screen (function menu). This allows you to access functions quickly.

Example of function menu

The displayed items differ depending on the camera status.

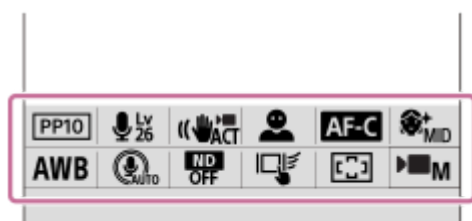

Hint

- Use MENU →  (Setup) → [Operation Customize] → [Fn Menu Settings] to register your favorite functions in the function menu. You can register 12 functions for shooting still images and 12 functions for shooting movies separately.
- When [Touch Operation] is set to [On] and [Shooting Screen] is set to [On], touch operations on the function menu screen are possible.
- When [Touch Operation] is set to [On] and [Shooting Screen] is set to [On], you can also open [Fn Menu Settings] by holding down the icon in the function menu.
- When [Swipe Up] under [Shooting Screen] is set to [Open the Fn Menu], the function menu can be displayed using touch operations by swiping the shooting screen upward quickly.
- Swipe downward from the area outside of the function menu or touch the area outside of the function menu to close the function menu.

1 Press the Fn (Function) button.

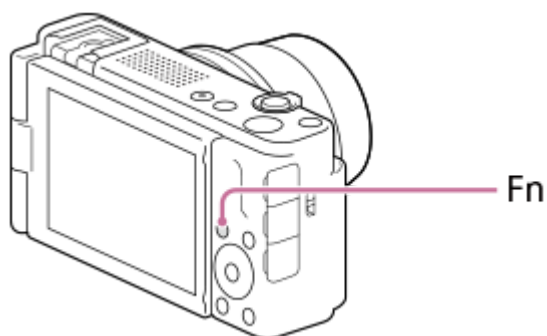

2 Press the top/bottom/left/right side of the control wheel to select a function to set.

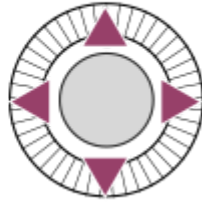

3 Select the desired setting by turning the control wheel, and press the center of the control wheel.

To adjust settings from the dedicated setting screens

Select the icon for the desired function and then press the center of the control wheel. The dedicated setting screen for the function will appear. Follow the operating guide **(A)** to adjust settings.

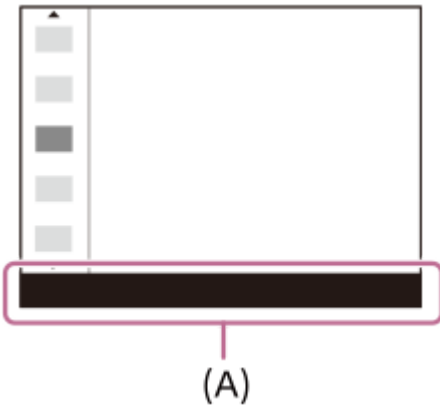

Related Topic

- [Fn Menu Settings](#)
- [DISP \(Display Setting\) button](#)
- [Touch Operation](#)
- [Shooting Screen](#)

Digital Camera
ZV-1M2

C (custom) buttons



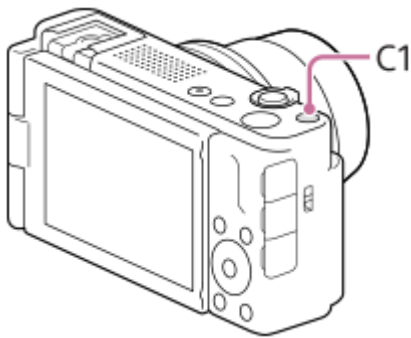

If you assign frequently used functions to the custom button (C1) in advance, you can quickly call up those functions simply by pressing the button during shooting or playback.

Recommended functions are assigned to the custom buttons by default.



To check/change the functions of the custom buttons

You can confirm the function currently assigned to each custom button via the following procedure.

MENU →  (Setup) → [Operation Customize] → [ Custom Key Setting], [ Custom Key Setting] or [ Custom Key Setting].

If you want to change the function of the custom button, press the center of the control wheel while the custom button is selected. The functions that can be assigned to that button will appear. Select your desired function.

Related Topic

- [Assigning frequently used functions to buttons \(Custom Key Setting\)](#)

Digital Camera
ZV-1M2

DISP (Display Setting) button

By pressing the DISP (Display Setting) button, you can change the content displayed on the screen during shooting and playback. The display switches each time the DISP button is pressed.

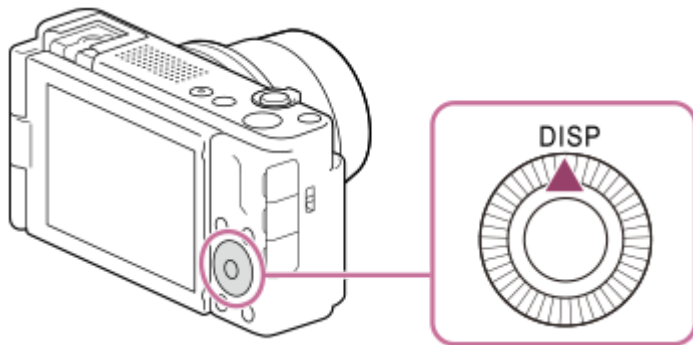

During shooting

Display All Info. → No Disp. Info. → Histogram → Level → Display All Info.

When shooting movies:

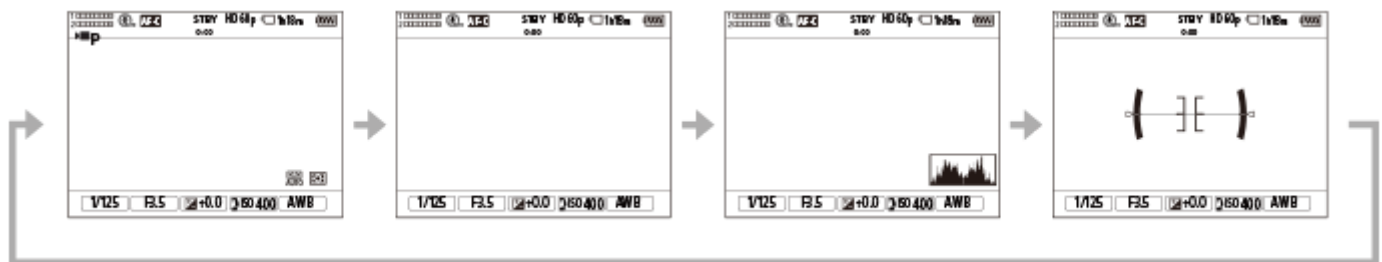



When shooting still images:

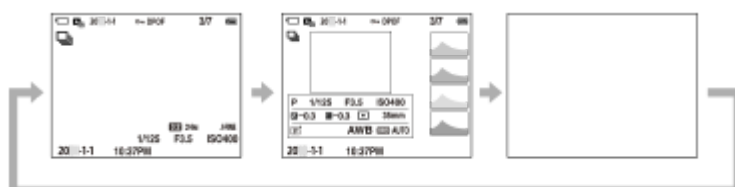

During playback

Display Info. → Histogram → No Disp. Info. → Display Info.



- If the image has an overexposed or underexposed area, the corresponding section will blink on the histogram display (overexposed/underexposed warning).
- The settings for playback are also applied in [ Auto Review].

Note

- The displayed contents and their position shown in the illustration are just a guideline, and may differ from the actual display.

Related Topic

- [DISP \(Screen Disp\) Set](#)



5-049-603-11(1) Copyright 2023 Sony Corporation

Digital Camera
ZV-1M2

Delete button

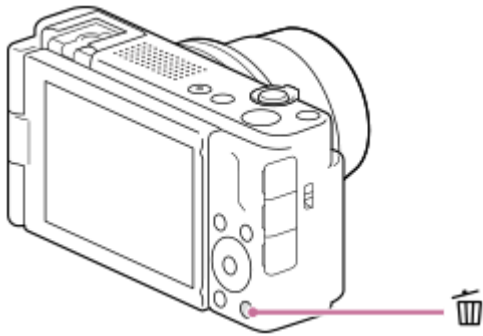
You can delete an image currently being displayed by pressing the  (Delete) button.



- When a confirmation message appears after you press the  (Delete) button, use the control wheel to select [Delete] and press the center.
- You can also delete two or more images at once.
Select MENU →  (Playback) → [Delete] → [Delete]. Then, select the images you want to delete.

Hint

- If you set MENU →  (Playback) → [Delete] → [ Delete pressing twice] to [On], you can delete images by pressing the  (Delete) button twice in a row.
- Other than the single-image playback screen, you can also use the  (Delete) button for the following operations.
 - Custom Key
 - In-Camera Guide

Related Topic

- [Deleting multiple selected images \(Delete\)](#)
- [Delete confirm.](#)
- [Delete pressing twice](#)
- [C \(custom\) buttons](#)
- [In-Camera Guide](#)

Keyboard screen

When manual character entry is required, a keyboard is displayed on the screen. For examples of functions that use the keyboard, see “Related Topic” at the bottom of this page.



1. Input box

The characters you entered are displayed.

2. Switch character types

Each time you press this key, the character type will switch between alphabet letters, numerals and symbols.

3. Keyboard

Each time you press this key, the characters corresponding to that key will be displayed one-by-one in order. To switch letters from lower to upper case, press **↑** (Up arrow).

4. **←** (Left arrow)

Moves the cursor in the input box to the left.

5. **→** (Right arrow)

Moves the cursor in the input box to the right. This key is also used to finalize the input of a character being edited and move to the next character.

6. **✕** (Delete)

Deletes the character preceding the cursor.

7. **↑** (Up arrow)

Switches a letter to upper or lower case.

8. **␣** (Space)

Enters a space.

9. **OK**

Press this key after entering characters to finalize the entered characters.

The procedure for entering alphabetic characters is explained below.

1 Use the control wheel to move the cursor to the desired key.

- Each time you press the center of the control wheel, the characters will change.
- To switch the letter to upper or lower case, press **↑** (Up arrow).

2 When the character that you want to enter appears, press **→** (Right arrow) to confirm the character.

- Make sure to confirm one character at a time. Unless a character is confirmed, you cannot enter the next character.
- Even if you do not press **→** (Right arrow), the entered character will be automatically confirmed after several seconds.

3 After you finish entering all characters, press **[OK]** to finalize the entered characters.

- To cancel input, select [Cancel].

Related Topic

- [Edit Device Name](#)

5-049-603-11(1) Copyright 2023 Sony Corporation

In-Camera Guide

The [In-Camera Guide] displays descriptions of MENU items, Fn (Function) items, and settings.

- 1 Select the MENU or Fn item for which you want to see a description, and then press the  (Delete) button (A).

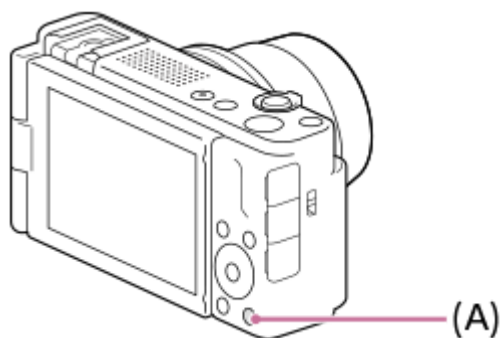

The descriptions of the item are displayed.

Inserting/removing the battery pack

- 1 Slide the switch on the battery/memory card cover to open the cover.

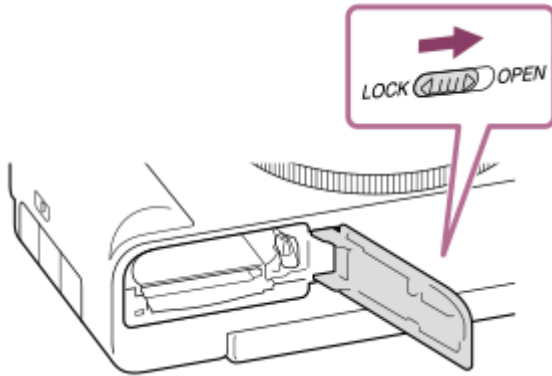

- 2 Insert the battery pack while pressing the lock lever (A) with the tip of the battery until the battery locks into place.

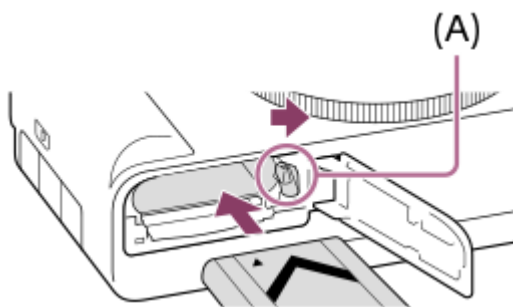

- 3 Close the cover and slide the switch to the LOCK side.

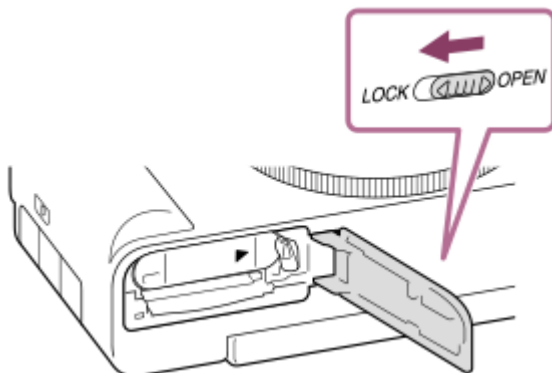

To remove the battery pack

Make sure that the access lamp is not lit, and turn off the camera. Then, slide the lock lever (A) and remove the battery pack. Be careful not to drop the battery pack.

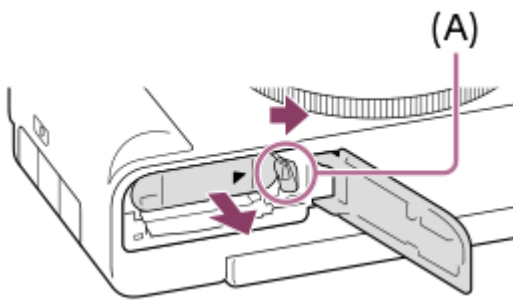

Related Topic

- [Charging the battery with a commercially available AC adaptor or mobile battery](#)
- [Notes on the battery pack and charging the battery](#)

5-049-603-11(1) Copyright 2023 Sony Corporation

Charging the battery with a commercially available AC adaptor or mobile battery

You can use a commercially available USB cable to charge from an external power source, such as a USB AC adaptor or mobile battery.

- 1 Turn off the camera, and connect an external power source to the USB Type-C terminal on the camera using a commercially available USB cable.

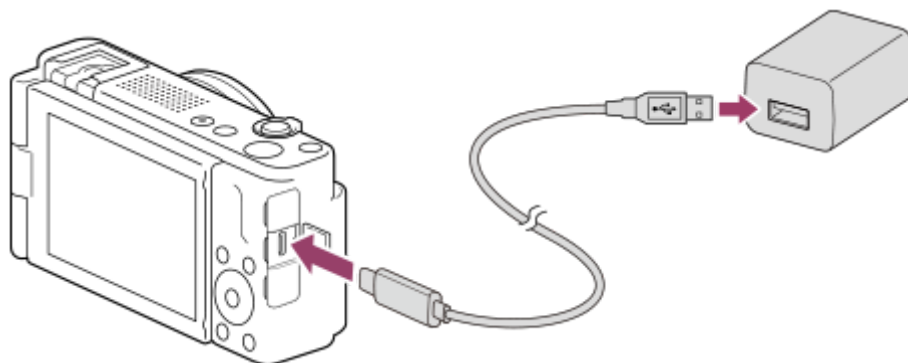

Charge lamp on the camera (orange)

Lit: Charging

Off: Charging finished

Flashing: Charging error or charging paused temporarily because the camera is not within the proper temperature range

- Charging time (Full charge): The charging time is approximately 150 min. (when using an AC adaptor with a rated output of 1.5 A).
- The above charging time applies when charging a fully depleted battery pack at a temperature of 25 °C (77 °F). Charging may take longer depending on conditions of use and circumstances.
- The charge lamp turns off when charging is completed.
- If the charge lamp lights up and then immediately turns off, the battery pack is fully charged.

Note

- When you use an AC adaptor, use one with a rated output of 1.5 A or higher.
- Use a nearby wall outlet (wall socket) when using the AC Adaptor/Battery Charger. If any malfunction occurs, disconnect the plug from the wall outlet (wall socket) immediately to disconnect from the power source. If you use the product with a charge lamp, note that the product is not disconnected from the power source even when the lamp turns off.
- If you turn on the camera, power will be supplied from the wall outlet (wall socket) and you will be able to operate the camera. However, the battery pack will not be charged.
- If the product is connected to a laptop computer that is not connected to a power source, the laptop battery level decreases. Do not leave the product connected to a laptop computer for an extended period of time.
- Do not turn on/off or restart the computer, or wake the computer from sleep mode when a USB connection has been established between the computer and the camera. Doing so may cause a malfunction. Before turning on/off or restarting the computer, or waking the computer from sleep mode, disconnect the camera from the computer.
- Charging cannot be guaranteed with a custom-built computer, modified computer, or a computer connected through a USB hub.
- The camera may not operate correctly when other USB devices are used at the same time.

- Before charging, be sure to also read [“Notes on the battery pack and charging the battery.”](#)

Related Topic

- [Inserting/removing the battery pack](#)
- [Notes on the battery pack and charging the battery](#)

5-049-603-11(1) Copyright 2023 Sony Corporation

Digital Camera
ZV-1M2

Using the battery charger abroad

You can use the battery charger (sold separately) in any country or region where the power supply is within 100 V to 240 V AC and 50 Hz/60 Hz.

Depending on the country/region, a converting plug adaptor may be needed to connect to a wall outlet (wall socket). Consult a travel agency, etc., and prepare one in advance.

Note

- Do not use an electronic voltage transformer as doing so may cause a malfunction.

Supplying power from a wall outlet (wall socket)

Use an AC adaptor, etc. to shoot and play back images while power is supplied from a wall outlet (wall socket). This conserves the camera's battery power.

- 1 Insert a sufficiently charged battery pack into the camera.**
 - The camera will not activate if there is no remaining battery. Insert a sufficiently charged battery pack into the camera.
- 2 Connect a commercially available USB cable to the USB Type-C terminal on the camera.**
- 3 Connect to a wall outlet (wall socket) using an AC adaptor, etc.**
- 4 Turn on the camera.**
 - An icon () indicating USB power supply will appear next to the battery display on the monitor, and power supply will start.

Note

- As long as the power is on, the battery pack will not be charged even if the camera is connected to the AC Adaptor, etc.
- Under certain conditions, power may be supplied from the battery pack supplementarily even if you are using the AC adaptor, etc.
- Do not remove the battery pack while power is supplied from a wall outlet (wall socket). If you remove the battery pack, the camera will be turned off.
- Only connect the USB cable to the camera or disconnect the USB cable from the camera while the camera is turned off.
- Depending on the camera and battery temperature, the continuous recording time may be shortened while power is supplied from a wall outlet (wall socket). The area around the terminal may become hot. Be careful when handling it.
- When using a mobile charger as a power source, confirm that it is fully charged before use. Also, be careful of the remaining power on the mobile charger during use.
- Operation cannot be guaranteed with all external power supplies.

Related Topic

- [Inserting/removing the battery pack](#)

Digital Camera
ZV-1M2

Memory cards that can be used

This camera supports SD memory cards and Memory Stick media.

When using microSD memory cards or Memory Stick Micro media with this camera, be sure to use the appropriate adaptor.

For still-image shooting

The following memory cards can be used.

- SD/SDHC/SDXC memory cards
- Memory Stick PRO Duo/Memory Stick PRO-HG Duo media

For movie recording

Movie recording formats and compatible memory cards are as follows.

Slow-motion and quick-motion movie shooting are not available with [XAVC S 4K].

▶ File Format	Supported memory card
XAVC S 4K 60Mbps*	<ul style="list-style-type: none"> ● SDHC/SDXC card (Class 10, or U1 or faster) ● Memory Stick PRO-HG Duo
XAVC S HD 50Mbps or lower*	<ul style="list-style-type: none"> ● SDHC/SDXC card (Class 10, or U1 or faster) ● Memory Stick PRO-HG Duo
XAVC S HD 60Mbps	<ul style="list-style-type: none"> ● SDHC/SDXC card (Class 10, or U1 or faster) ● Memory Stick PRO-HG Duo
XAVC S 4K 100Mbps*	<ul style="list-style-type: none"> ● SDHC/SDXC card (U3)
XAVC S HD 100Mbps	<ul style="list-style-type: none"> ● SDHC/SDXC card (U3)

* Including when recording proxy movies at the same time

Note

- When an SDHC memory card is used to record an XAVC S movie over extended periods of time, the recorded movies will be divided into files 4 GB in size.
- Charge the battery pack sufficiently before attempting to recover the database files on the memory card.

Related Topic

- Notes on memory card
- Number of recordable images
- Recordable movie times
- S&Q Settings

5-049-603-11(1) Copyright 2023 Sony Corporation

Inserting/removing a memory card

Explains how to insert a memory card (sold separately) to the camera. You can use SD memory cards and Memory Stick media with this camera.

- 1 Slide the switch on the battery/memory card cover to open the cover.

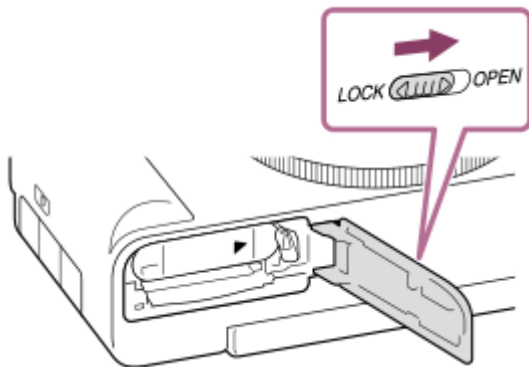

- 2 Insert the memory card.

- With the notched corner facing in the direction illustrated, insert the memory card until it clicks into place. Insert the memory card correctly. Not doing so may cause a malfunction.

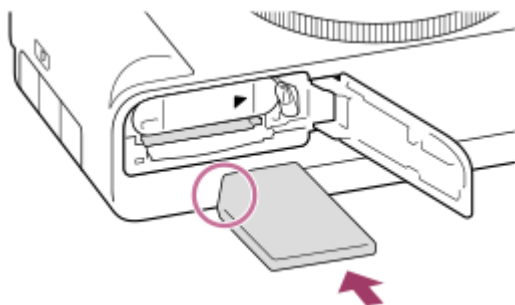

- 3 Close the cover, and then slide the switch towards the LOCK side.

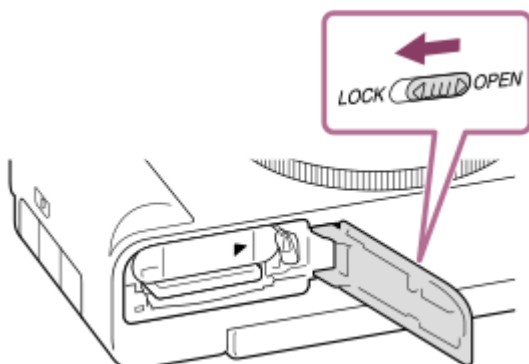

Hint

- When you use a memory card with the camera for the first time, it is recommended that you format the card on the camera for more stable performance of the memory card.

To remove the memory card

Open the memory card cover and make sure that the access lamp **(A)** is not lit, then push in the memory card lightly once to remove it.

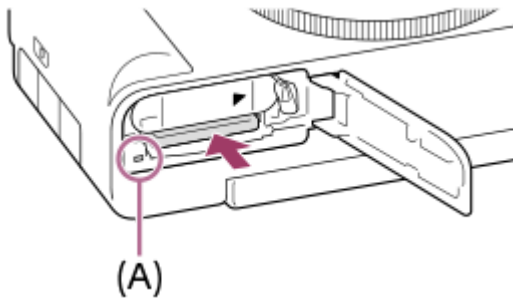

Related Topic

- [Memory cards that can be used](#)
- [Notes on memory card](#)
- [Format](#)



Performing initial setup for the camera

By establishing a Bluetooth connection (pairing) between the camera and a smartphone and using the smartphone application Creators' App, you can perform initial camera settings such as date and time settings from the smartphone. Install Creators' App from your smartphone's application store. If the application is already installed, be sure to update it to the latest version.

You can also install Creators' App by scanning the QR Code displayed on the screen of the camera using your smartphone.

For details on Creators' App, refer to the following website.

<https://www.sony.net/ca/>

- 1 Press the ON/OFF (Power) button to turn on the camera.**
- 2 Select the desired language and then press the center of the control wheel.**
 - The privacy notice screen will appear. Read the privacy notice regarding biometrics by opening the link using your smartphone, etc.
- 3 Press the center of the control wheel.**
- 4 Follow the instructions on the camera screen to connect the camera with your smartphone.**
 - Launch Creators' App on your smartphone to connect the camera with your smartphone.
 - If you do not connect a smartphone, the area/date/time setting screen will appear.
 - To connect your smartphone to the camera after the initial setup, select MENU →  (Network) → [] Cnct./PC Remote] → [Smartphone Connection].
- 5 Perform initial camera setup on the Creators' App screen.**
 - Follow the instructions on the screen to set the following items.
 - Area/Date/Time
 - Auto Power OFF Temp.
 - Device name

You can change these settings later from the camera menu.

On maintaining the date and time

This camera has an internal rechargeable backup battery for maintaining the date and time and other settings regardless of whether the power is turned on or off, or whether the battery pack is charged or discharged.

To charge the internal backup battery, insert a charged battery pack into the camera, and leave the product for 24 hours or more with the power turned off.

If the clock resets every time the battery pack is charged, the internal rechargeable backup battery may be worn out. Consult your service facility.

Hint

- By connecting the camera and a smartphone via the Bluetooth function, you can operate the camera using the smartphone and transfer images from the camera to the smartphone.

Note

- If the date and time setting is canceled halfway, the setting screen for the date and time appears every time you turn on the camera.
- The built-in clock of the camera may exhibit time errors. Adjust the time at regular intervals.

Related Topic

- [Pairing the camera with a smartphone \(Smartphone Connection\)](#)
- [Area/Date/Time Setting](#)
- [Auto Power OFF Temp.](#)
- [Edit Device Name](#)
- [Privacy Notice](#)

Digital Camera
ZV-1M2

Confirmation before shooting

This section introduces useful settings and functions that you should know when using the camera. We recommend that you confirm these settings and functions before using the camera.

From each item name listed below, you can jump to the page explaining the respective functions.

Preparing a memory card for use with this camera

- [Format](#)
- [Recover Image DB \(still image/movie\)](#)

Preventing accidental failure to insert a memory card

- [Release w/o Card](#)

Setting whether camera operating sounds are generated

- [Audio signals](#)

Convenient functions for shooting self-portrait videos and vlogs

- [Product Showcase Set](#)
- [Background Defocus](#)
- [Cinematic Vlog Set.](#)
- [Microphone Directivity](#)

Making it easy to check whether the camera is on standby or recording when set to a movie mode

- [Emphasized REC Display](#)

Resetting shooting settings or resetting all camera settings

- [Setting Reset](#)

Shooting movies (Intelligent Auto)

This section describes how to record movies in the [Intelligent Auto] mode. In the [Intelligent Auto] mode, the camera automatically focuses and automatically determines the exposure based on the recording conditions.

- 1 Press the Still/Movie/S&Q button (A) to select the movie recording mode.

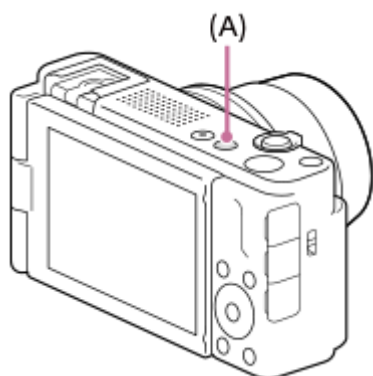

- Each time you press the button, the shooting mode switches in the order of still image shooting mode, movie recording mode, and slow-motion/quick-motion recording mode.

- 2 MENU →  (Shooting) → [Shooting Mode] → [ Shoot Mode] → [Intelligent Auto].

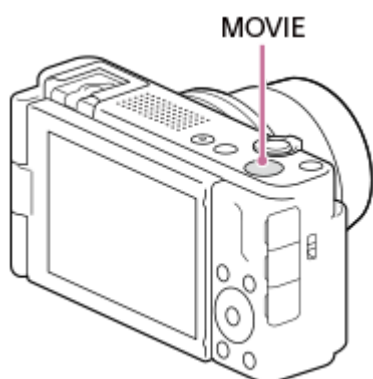

The shooting mode will be set to  (Intelligent Auto).

- 3 Press the MOVIE (Movie) button to start recording.







- 4 Press the MOVIE button again to stop recording.

To shoot with the touch function icons

You can also start shooting by touching an icon on the screen instead of pressing the MOVIE (movie) button. Swipe the monitor left or right to display the touch function icons, and then touch the  (start recording) icon. You can view the captured image by touching the  (switch to playback screen) icon.

For details on how to display the touch function icons, see [“Touch function icons.”](#)

To adjust the image brightness, color tone, etc. (My Image Style)

Swipe the monitor left or right to display the touch function icons on the shooting screen, and touch  (image adjustment). You can set  (Brightness),  (Color), and [ Creative Look] to your preferences. Touch each icon at the bottom of the screen to set each item.

For details, refer to “[Adjusting images in the auto mode \(My Image Style\)](#).”

To select the recording format (File Format)

The resolution and degree of compatibility vary depending on the recording format (XAVC S 4K/XAVC S HD). Select the format in accordance with the purpose of the movie to be shot.

To select the frame rate or image quality (Movie Settings)

The frame rate determines the smoothness of motion in movies. ([ Movie Settings] → [Rec Frame Rate])

The image quality changes with the bit rate. ([ Movie Settings] → [Record Setting])

If the bit rate is high, the amount of information will increase and you can shoot high-quality movies. However, this will result in a larger volume of data.



Select the frame rate and bit rate according to your preference and purpose.

To adjust the exposure (Shoot Mode)

You can select the exposure mode in [ Shoot Mode]. Select the exposure mode through the combination of a shutter speed and aperture value.

Also, if you enable [Touch AE] under [Touch Func. in Shooting], you can adjust the exposure to the touched area.

To select the focusing method (Focus Mode/ Focus Area)

Select **AF-C** (Continuous AF) or **MF** (Manual Focus) for [ Focus Mode]. You can specify the focus area by setting [ Focus Area].

Hint

- You can also assign the start/stop movie recording function to a preferred key.
- You can change the settings for ISO sensitivity, exposure compensation, and focus area while shooting movies.
- The sounds of the camera and lens in operation may be recorded during movie shooting. To prevent sounds from being recorded, set [Audio Recording] to [Off].
- When [Auto Power OFF Temp.] is set to [High], the camera can continue movie recording even when the temperature of the camera becomes high.

Note

- An icon indicating that data is being written is displayed after shooting. Do not remove the memory card while the icon is displayed.
- You cannot start recording a movie while writing data. Wait until data writing is completed and “STBY” is displayed before recording a movie.
- If the  (Overheating warning) icon appears, the temperature of the camera has risen. Turn the power off and cool the camera and wait until the camera is ready to shoot again.
- The temperature of the camera tends to rise when shooting movies continuously, and you may feel that the camera is warm. This is not a malfunction. Also, [Internal temp. high. Allow it to cool.] may appear. In such cases, turn the power off and cool the camera and wait until the camera is ready to shoot again.
- For the continuous shooting time of a movie recording, refer to “[Recordable movie times](#).” When movie recording is finished, you can record another movie by pressing the MOVIE button again. Recording may stop to protect the product, depending on the temperature of the product or the battery.
- Still images cannot be captured during movie recording.

Related Topic

- [Touch function icons](#)
- [Adjusting images in the auto mode \(My Image Style\)](#)
- [File Format \(movie\)](#)
- [Movie Settings \(movie\)](#)
- [Selecting the focus method \(Focus Mode\)](#)
- [Selecting the focus area \(Focus Area\)](#)
- [Assigning frequently used functions to buttons \(Custom Key Setting\)](#)
- [REC w/ Shutter \(movie\)](#)
- [Audio Recording](#)
- [Auto Power OFF Temp.](#)
- [Recordable movie times](#)

5-049-603-11(1) Copyright 2023 Sony Corporation

Shooting still images (Intelligent Auto)

This section describes how to shoot still images in the [Intelligent Auto] mode. In the [Intelligent Auto] mode, the camera automatically focuses and automatically determines the exposure based on the shooting conditions.

- 1 Press the Still/Movie/S&Q button (A) to select the still image shooting mode.

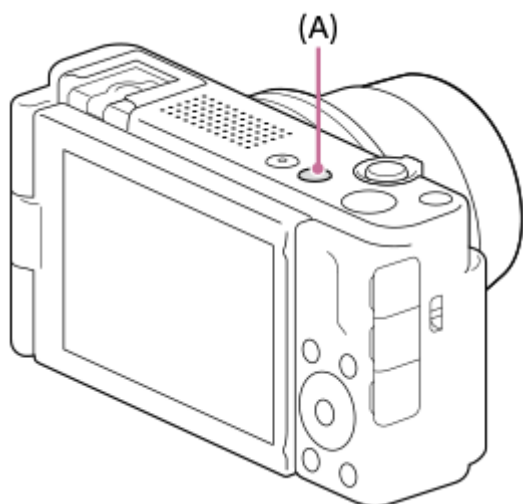

- Each time you press the button, the shooting mode switches in the order of still image shooting mode, movie recording mode, and slow-motion/quick-motion recording mode.

- 2 MENU →  (Shooting) → [Shooting Mode] → [ Shoot Mode] → [Intelligent Auto].

The shooting mode will be set to  (Intelligent Auto).

- 3 Adjust the monitor angle, and hold the camera.

- 4 Enlarge images with the W/T (zoom) lever when shooting.

- 5 Press the shutter button halfway down to focus.

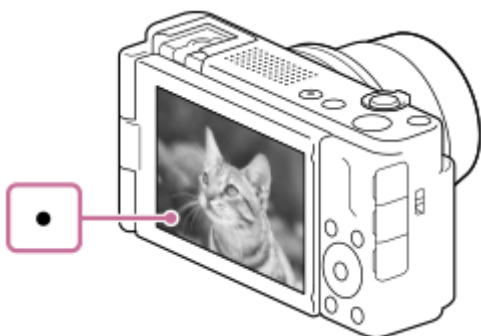

When the image is in focus, a beep sounds and the indicator ( , etc.) lights up.



- The shortest shooting distance is approximately 5 cm (0,16 ft.) (W), 15 cm (0,49 ft.) (T) (from the lens).





6 Press the shutter button fully down.

To shoot with the touch function icons

You can also shoot by touching an icon on the screen instead of pressing the shutter button. Swipe the monitor left or right to display the touch function icons, and then touch the  (shutter) icon. You can view the captured image by touching the  (switch to playback screen) icon.



For details on how to display the touch function icons, see “[Touch function icons](#).”

To adjust the image brightness, color tone, etc. (My Image Style)

Swipe the monitor left or right to display the touch function icons on the shooting screen, and touch  (image adjustment). You can set  (Brightness), , and [ Creative Look] to your preferences. Touch each icon at the bottom of the screen to set each item.

For details, refer to “[Adjusting images in the auto mode \(My Image Style\)](#).”

To select the focus mode yourself (Focus Mode / Focus Area)



Specifying [ Focus Mode], such as selecting **AF-S** (Single-shot AF) for landscapes or still subjects and selecting **AF-C** (Continuous AF) for moving subjects, makes it easier to focus on the desired subject. You can also specify the focus position and range using [ Focus Area].

Shooting while focusing on human eyes

The [ Subject Recog in AF] function under [Subject Recognition] is enabled in the default settings, so you can use the Eye AF function immediately.

To shoot images with the focus locked on the desired subject (Focus-lock)

When you focus on the subject, the focus is locked while the shutter button is pressed halfway down. Switch to the desired composition and press the shutter button all the way down to take the picture.

- You can lock the focus on non-moving subjects. Set [ Focus Mode] to **AF-S** (Single-shot AF).
- Setting [ Focus Area] to [Center Fix] makes it easier to focus on subjects located in the center of the screen.

Hint

- When the product cannot focus automatically, the focus indicator flashes and the beep does not sound. Either recompose the shot or change the focus mode or focus area settings. In [Continuous AF] mode,  (focus indicator) lights up and the beep indicating that the focus has been achieved does not sound.

Note

- An icon indicating that data is being written is displayed after shooting. Do not remove the memory card while the icon is displayed. Doing so will prevent images from being recorded normally.

Related Topic

- [Touch function icons](#)
- [Adjusting images in the auto mode \(My Image Style\)](#)
- [Selecting the focus method \(Focus Mode\)](#)
- [Selecting the focus area \(Focus Area\)](#)
- [Playing back still images](#)
- [Auto Review \(still image\)](#)

Finding functions from MENU

The displayed MENU items vary depending on the shooting mode. In the table below, the modes in which each MENU item is displayed are indicated by the still image/movie/S&Q icons.





































































































- : The menu item is displayed when the shooting mode is set to the still image shooting modes (A).
- : The menu item is displayed when the shooting mode is set to the movie recording modes (B).
- : The menu item is displayed when the shooting mode is set to either the still image shooting modes (A) or the movie recording modes (B).











































(Main) tab

Shooting settings are displayed in a list. For details, refer to “[Main menu \(shooting setting list\)](#).”

































































/ (Shooting) tab







Groups		Menu items
Image Quality/Rec		File Format
		JPEG Quality
		JPEG Image Size
		Aspect Ratio
		File Format
		Movie Settings
		S&Q Settings
		Proxy Settings
		High ISO NR
		Color Space
Media		Format
		Recover Image DB
		Display Media Info.

Groups	  	Menu items
File	  	File/Folder Settings
	  	Select REC Folder
	  	Create New Folder
	  	 Write Serial Number
	  	File Settings
Shooting Mode	  	 Shoot Mode
	  	 Shoot Mode
	  	 Shoot Mode
	  	 Camera Set. Memory
Drive Mode	  	Drive Mode
	  	Bracket Settings
	  	Interval Shoot Func.
Shutter/Silent	  	 Silent Mode
	  	Release w/o Card
Audio Recording	  	Audio Recording
	  	Audio Rec Level
	  	Wind Noise Reduct.
	  	Microphone Directivity
	  	Mic Direct Select Setting
TC/UB	  	Time Code Preset
	  	User Bit Preset
	  	Time Code Format
	  	Time Code Run
	  	Time Code Make
	  	User Bit Time Rec
Image Stabilization	  	 SteadyShot
Zoom	  	 Zoom Range
	  	Zoom Speed
	  	 Step Zoom Magnif.



































































































Groups	  	Menu items
Shooting Display	  	 Grid Line Display
	  	 Grid Line Type
	  	Live View Display
	  	Emphasized REC Display
Marker Display	  	Marker Display
	  	Center Marker
	  	Aspect Marker
	  	Safety Zone
	  	Guideframe
Shooting Option	  	 Product SC Set
	  	Cinematic Vlog Set.
	  	 Self-timer

 (Exposure/Color) tab



































































Groups	  	Menu items
Exposure	  	Auto Slow Shutter
	  	 ISO
	  	ISO AUTO Min. SS
	  	 ND Filter
Exposure Comp.	  	 Exposure Comp.
Metering	  	 Metering Mode
	  	 Face Priority in Multi Metering
Flash	  	Flash Mode
	  	Flash Comp.
	  	Exp.comp.set
White Balance	  	 White Balance
	  	 Priority Set in AWB
	  	Shutter AWB Lock
Color/Tone	  	 D-Range Optimizer
	  	 Creative Look
	  	 Picture Profile
	  	 Soft Skin Effect

Groups	  	Menu items
Zebra Display	  	 Zebra Display
	  	 Zebra Level





























AF_{MF} (Focus) tab



















Groups	  	Menu items
AF/MF	  	 Focus Mode
	  	Pre-AF
	  	AF Transition Speed
	  	AF Subj. Shift Sensitivity
	  	 Set Focus
Focus Area	  	 Focus Area
	  	 Focus Area Limit
	  	 Focus Area Color
	  	AF Area Auto Clear
	  	AF-C Area Display
	  	Phase Detect. Area
	  	 Circ. of Focus Point
Subject Recognition	  	 Subject Recog in AF
	  	 Recognition Target
	  	 Right/Left Eye Select
	  	 Sbj Recog Frm Disp.
	  	Face Memory
	  	 Regist. Faces Priority
Focus Assistant	  	 Auto Magnifier in MF
	  	Focus Magnifier
	  	 Focus Magnif. Time
	  	 Initial Focus Mag.
	  	 Initial Focus Mag.
Peaking Display	  	 Peaking Display
	  	 Peaking Level
	  	 Peaking Color

 (Playback) tab



















































Groups	  	Menu items
Playback Target	  	View Mode
Magnification	  	 Enlarge Image
	  	 Enlarge Initial Mag.
	  	 Enlarge Initial Position
Selection/Memo	  	Protect
	  	Rating
	  	Rating Set(Custom Key)
Delete	  	Delete
	  	 Delete pressing twice
	  	Delete confirm.
Edit	  	Rotate
	  	Photo Capture
Viewing	  	Cont. Play for  Interval
	  	Play Speed for  Interval
	  	Slide Show
Playback Option	  	Image Index
	  	Display as Group
	  	Display Rotation
	  	Disp Specified Time Img.























































 (Network) tab

Groups	  	Menu items
 Cnct./PC Remote	  	Smartphone Connection
	  	 Select on Cam & Send
	  	 Reset Transfer Status
	  	 Cnct. while Power OFF
	  	Remote Shoot Setting
Wi-Fi	  	Display Wi-Fi Info.
	  	SSID/PW Reset





















Groups	  S&Q	Menu items
Bluetooth	  S&Q	Bluetooth Function
	  S&Q	Pairing
	  S&Q	Manage Paired Device
	  S&Q	Bluetooth Rmt Ctrl
	  S&Q	Disp Device Address
Network Option	  S&Q	Airplane Mode
	  S&Q	Edit Device Name
	  S&Q	Reset Network Set.

 (Setup) tab

Groups	  S&Q	Menu items
Area/Date	  S&Q	 Language
	  S&Q	Area/Date/Time Setting
	  S&Q	NTSC/PAL Selector
Reset Settings	  S&Q	Setting Reset
Operation Customize	  S&Q	 Custom Key Setting
	  S&Q	 Custom Key Setting
	  S&Q	 Custom Key Setting
	  S&Q	Fn Menu Settings
	  S&Q	DISP (Screen Disp) Set
	  S&Q	 REC w/ Shutter
Touch Operation	  S&Q	Touch Operation
	  S&Q	Shooting Screen
	  S&Q	Playback Screen
	  S&Q	Menu Screen
 Accessibility	  S&Q	Screen Reader
Monitor	  S&Q	Monitor Brightness
	  S&Q	Monitor Flip Direction
Display Option	  S&Q	TC/UB Disp. Setting
	  S&Q	Gamma Display Assist
	  S&Q	Gamma Disp. Assist Typ.
	  S&Q	 Auto Review

Groups	  	Menu items
Power Setting Option	  	 Auto Monitor OFF
	  	Power Save Start Time
	  	Power OFF w/ monitor
	  	Auto Power OFF Temp.
Sound Option	  	Volume Settings
	  	Audio signals
USB	  	USB Connection Mode
	  	USB LUN Setting
	  	USB Power Supply
External Output	  	 HDMI Resolution
	  	 HDMI Output Settings
	  	HDMI Info. Display
	  	CTRL FOR HDMI
Setup Option	  	REC Lamp
	  	Version
	  	Privacy Notice

☆ (My Menu) tab

Groups	  	Menu items
My Menu Setting	  	Add Item
	  	Sort Item
	  	Delete Item
	  	Delete Page
	  	Delete All
	  	Display From My Menu

Note

- The order in which the menu tabs are listed here differs from the actual display.

Contents of this chapter

The following table of contents lists the features described in this chapter (“Using the shooting functions”). From each item name, you can jump to the page describing the respective functions.

Selecting a shooting mode

- [Shoot Mode \(still image\)/Shoot Mode \(movie\)/Shoot Mode \(S&Q\)](#)
- [Shoot Mode: Intelligent Auto](#)
- [Shoot Mode: Scene Selection](#)
- [Adjusting images in the auto mode \(My Image Style\)](#)
- [Shoot Mode: Program Auto](#)
- [Shoot Mode: Aperture Priority](#)
- [Shoot Mode: Shutter Priority](#)
- [Shoot Mode: Manual Exposure](#)

Convenient functions for shooting self-portrait videos and vlogs

- [Product Showcase Set](#)
- [Background Defocus](#)
- [Cinematic Vlog Set.](#)
- [Self-timer \(movie\)](#)

Focusing

- [Selecting the focus method \(Focus Mode\)](#)
- [Selecting the focus area \(Focus Area\)](#)
- [Tracking subject \(Tracking function\)](#)
- [Manual Focus \(Set Focus\)](#)
- [Direct manual focus \(DMF\)](#)

Subject Recognition

- [Focusing on human eyes](#)
- [Subject Recog in AF \(still image/movie\)](#)
- [Recognition Target \(still image/movie\)](#)
- [Right/Left Eye Select \(still image/movie\)](#)
- [Sbj Recog Frm Disp. \(still image/movie\)](#)
- [Face Memory](#)
- [Regist. Faces Priority \(still image/movie\)](#)

Using focusing functions

- [Focus Standard](#)
- [Focus Area Limit \(still image/movie\)](#)
- [Circ. of Focus Point \(still image/movie\)](#)
- [Focus Area Color \(still image/movie\)](#)
- [AF Area Auto Clear](#)
- [AF-C Area Display](#)
- [Phase Detect. Area](#)
- [AF Transition Speed](#)
- [AF Subj. Shift Sensitivity](#)
- [AF/MF Selector](#)
- [Pre-AF](#)

- Auto Magnifier in MF (still image/movie)
- Focus Magnifier
- Focus Magnif. Time (still image/movie)
- Initial Focus Mag. (movie)
- Initial Focus Mag. (still image)
- Peaking Display

Adjusting the exposure/metering modes

- Exposure Comp. (still image/movie)
- Histogram display
- D-Range Optimizer (still image/movie)
- Metering Mode (still image/movie)
- Face Priority in Multi Metering (still image/movie)
- ND Filter (still image/movie)
- AE lock
- Auto Slow Shutter
- Zebra Display

Selecting the ISO sensitivity

- ISO (still image/movie)
- ISO AUTO Min. SS

White balance

- White Balance (still image/movie)
- Capturing a standard white color to set the white balance (custom white balance)
- Priority Set in AWB (still image/movie)
- Shutter AWB Lock

Adding effects to images

- Creative Look (still image/movie)
- Picture Profile (still image/movie)
- Soft Skin Effect (still image/movie)

Shooting with drive modes (continuous shooting/self-timer)

- Drive Mode
- Cont. Shooting
- Self-timer(Single)
- Self-timer(Cont)
- Cont. Bracket
- Single Bracket
- Indicator during bracket shooting
- WB bracket
- DRO Bracket
- Bracket Settings

Self-timer (movie)

Interval Shoot Func.

Setting the image quality and recording format

- File Format (still image)
- JPEG Quality
- JPEG Image Size
- Aspect Ratio
- Color Space
- File Format (movie)

- [Movie Settings \(movie\)](#)
- [S&Q Settings](#)
- [Proxy Settings](#)

Using touch functions

- [Touch Operation](#)
- [Shooting Screen](#)
- [Playback Screen](#)
- [Menu Screen](#)
- [Focusing using touch operations \(Touch Focus\)](#)
- [Starting tracking with touch operations \(Touch Tracking\)](#)
- [Shooting with touch operations \(Touch Shutter\)](#)
- [Adjusting the exposure with touch operations \(Touch AE\)](#)

Shutter settings

- [Silent Mode \(still image/movie\)](#)
- [Release w/o Card](#)

Using the zoom

- [The zoom features available with this product](#)
- [Zoom](#)
- [Zoom Range \(still image/movie\)](#)
- [Zoom Speed](#)
- [Step Zoom Magnif. \(still image/movie\)](#)
- [About zoom scale](#)

Using the flash

- [Using flash \(sold separately\)](#)
- [Flash Mode](#)
- [Flash Comp.](#)
- [Exp.comp.set](#)

Reducing blur

- [SteadyShot \(movie\)](#)

Noise reduction

- [High ISO NR](#)

Setting the monitor display during shooting

- [Auto Review \(still image\)](#)
- [Grid Line Display \(still image/movie\)](#)
- [Grid Line Type \(still image/movie\)](#)
- [Live View Display](#)
- [Bright Monitoring](#)
- [Emphasized REC Display](#)
- [Marker Display](#)
- [Gamma Display Assist](#)
- [Gamma Disp. Assist Typ.](#)

Recording movie audio

- [Audio Recording](#)
- [Audio Rec Level](#)
- [Wind Noise Reduct.](#)
- [Microphone Directivity](#)
- [Mic Direct Select Setting](#)

TC/UB settings

- TC/UB
- TC/UB Disp. Setting

Livestreaming video and audio (USB Streaming)

5-049-603-11(1) Copyright 2023 Sony Corporation

Shoot Mode (still image)/Shoot Mode (movie)/Shoot Mode (S&Q)



You can set the shooting mode according to the subject you want to shoot or the function you want to adjust.

- 1 Press the Still/Movie/S&Q button to select the desired shooting mode.
- 2 MENU → / (Shooting) → [Shooting Mode] → [Shoot Mode]/[Shoot Mode]/[Shoot Mode] → desired setting.

Menu item details

Intelligent Auto:

The camera shoots with automatically adjusted settings.

Program Auto:

Allows you to shoot with the exposure adjusted automatically (both the shutter speed and the aperture value).

Aperture Priority:

You can shoot by adjusting the aperture and changing the range in focus, or by defocusing the background.

Shutter Priority:

By adjusting the shutter speed, you can shoot still images with different effects for moving objects, or record movies with natural movement.

Manual Exposure:

You can shoot with the desired exposure setting by adjusting both the shutter speed and aperture.

Cam.Set:

Allows you to shoot an image after recalling often-used modes or camera settings registered in advance.

Scene Selection (only when shooting still images):

Allows you to shoot with preset settings according to the scene.

Related Topic

- [Shoot Mode: Intelligent Auto](#)
- [Shoot Mode: Program Auto](#)
- [Shoot Mode: Aperture Priority](#)
- [Shoot Mode: Shutter Priority](#)
- [Shoot Mode: Manual Exposure](#)
- [Recalling registered shooting settings \(Cam.Set\)](#)
- [Shoot Mode: Scene Selection](#)

Shoot Mode: Intelligent Auto



The camera shoots images with automatically adjusted settings.

- 1 Press the Still/Movie/S&Q button to select the desired shooting mode.
- 2 MENU → / (Shooting) → [Shooting Mode] → [Shoot Mode]/[Shoot Mode]/[Shoot Mode] → [Intelligent Auto].
- 3 Point the camera at the subject.
- 4 Adjust the focus and shoot the image.

To adjust the image brightness, color tone, etc. (My Image Style)

Swipe the monitor left or right to display the touch function icons on the shooting screen, and touch (image adjustment). You can set (Brightness), (Color), and [Creative Look] to your preferences. Touch each icon at the bottom of the screen to set each item.

For details, refer to “ [Adjusting images in the auto mode \(My Image Style\)](#) .”

Hint

- If the camera detects that the subject is moving when shooting still images, the (motion) mark will appear.

Note

- In the [Intelligent Auto] mode, when the camera recognizes multiple people, it changes the aperture so that the recognized faces can be captured clearly. However, depending on the shooting conditions, not all recognized faces may be captured clearly. This function does not work in the following cases.
 - When shooting still images
 - When the [Background Defocus] button is pressed
 - When [Subject Recog in AF] is set to [Off]
 - When [Recognition Target] is [Animal]

Related Topic

- [Touch function icons](#)
- [Adjusting images in the auto mode \(My Image Style\)](#)
- [Creative Look \(still image/movie\)](#)

Shoot Mode: Scene Selection



Allows you to shoot with preset settings according to the scene.

- 1 Press the Still/Movie/S&Q button to select the still image shooting mode.
- 2 MENU → (Shooting) → [Shooting Mode] → [Shoot Mode] → [Scene Selection].
- 3 Select the desired mode in scene selection.

Menu item details

Portrait:

Blurs background and sharpens the subject. Accentuates the skin tones softly.



Sports Action:

Shoots a moving subject at a fast shutter speed so that the subject looks as if it is standing still. The product shoots images continuously while the shutter button is pressed.



Macro:

Shoots close-ups of the subjects, such as flowers, insects, food, or small items.



Landscape:

Shoots the entire range of a scenery in sharp focus with vivid colors.



Sunset:

Shoots the red of the sunset beautifully.

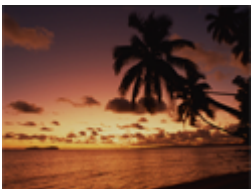

Night Scene:

Shoots night scenes without losing the dark atmosphere.







Night Portrait:

Shoots night scene portraits using the flash (sold separately).



To adjust the image brightness, color tone, etc. (My Image Style)

Swipe the monitor left or right to display the touch function icons on the shooting screen, and touch  (image adjustment). You can set  (Brightness),  (Color), and [ Creative Look] to your preferences. Touch each icon at the bottom of the screen to set each item.

For details, refer to “[Adjusting images in the auto mode \(My Image Style\)](#) .”

Related Topic

- [Touch function icons](#)
- [Adjusting images in the auto mode \(My Image Style\)](#)
- [Creative Look \(still image/movie\)](#)

Adjusting images in the auto mode (My Image Style)

You can adjust the brightness and the color tone of the image, and select the finish of the image in the [Intelligent Auto] or [Scene Selection] mode using the touch function icons on the screen.

Set the camera as follows beforehand.

- [Touch Operation]: [On]
- [Shooting Screen]:
 - Set [Shooting Screen] to [On].
 - Set [Footer Icon Touch] to [On].

1 Touch (image adjustment) icon on the shooting screen in the [Intelligent Auto] or [Scene Selection] mode.

Image adjustment is enabled.

- To adjust images to your preferences, you need to display the touch function icons on the screen in advance. If the icons are not displayed, swipe the screen to the left or right to display them.

For details, refer to “[Touch function icons.](#)”

2 Set , , and [Creative Look] in the footer (bottom of the screen) to the desired values.



- Touch [AUTO] or press the  (delete) button to return to the camera's automatic settings.

3 Shoot an image.

- The adjusted values can be reset by touching the  (image adjustment) icon. The original shooting settings for [Intelligent Auto] or [Scene Selection] will be applied.

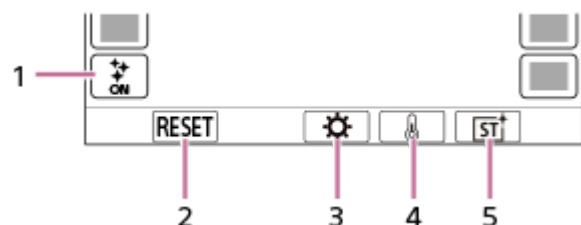

Details of the image adjustment screen



1.  (image adjustment) icon
2. RESET: Resets all changes.
3. Brightness: Sets a value from [Dark] to [Bright] using the slider.
4. Color: Sets a value from [Cool] to [Warm] using the slider.
5.  Creative Look: Selects [Auto], ST, PT, NT, VV, VV2, FL, IN, SH, BW, or SE.

Note

- Image adjustments are not reflected when you change the shooting mode or when you start recording movies in the still image mode. In addition, settings that were adjusted prior to that point will be reset.

- When [Cinematic Vlog Set.] is set to [On],  (Color) and [ Creative Look] cannot be adjusted.
- If you touch the screen while the touch AE function is enabled, the  (Brightness) setting will be temporarily disabled, and the exposure will be set according to the brightness of the touched area.

Related Topic

- [Touch Operation](#)
- [Shooting Screen](#)
- [Touch function icons](#)
- [Shoot Mode: Intelligent Auto](#)
- [Shoot Mode: Scene Selection](#)
- [Creative Look \(still image/movie\)](#)

5-049-603-11(1) Copyright 2023 Sony Corporation

Shoot Mode: Program Auto



Allows you to shoot with the exposure adjusted automatically (both the shutter speed and the aperture value). You can set shooting functions such as [ISO].

- 1 Press the Still/Movie/S&Q button to select the desired shooting mode.
- 2 MENU → / (Shooting) → [Shooting Mode] → [Shoot Mode]/[Shoot Mode]/[Shoot Mode] → [Program Auto].
- 3 Set the shooting functions to your desired settings.
- 4 Adjust the focus and shoot the subject.

Program Shift (only during still image shooting)

When you are not using a flash, you can change the shutter speed and aperture (F-value) combination without changing the appropriate exposure set by the camera.

Turn the control wheel to select the aperture value and shutter speed combination.

- “P” on the screen changes to “P*” when you turn the control wheel.
- To cancel program shift, set the shooting mode to other than [Program Auto], or turn off the camera.
- If [Footer Icon Touch] under [Shooting Screen] is set to [On], you can also perform program shift by touching the shutter speed and aperture display area at the bottom of the screen.





Note

- According to the brightness of the environment, the program shift may not be used.
- Set the shooting mode to another one than “P” or turn off the power to cancel the setting you made.
- When the brightness changes, the aperture (F-value) and shutter speed also change while maintaining the shift amount.

Shoot Mode: Aperture Priority



You can shoot by adjusting the aperture and changing the range in focus, or by defocusing the background.

- 1 Press the Still/Movie/S&Q button to select the desired shooting mode.**
- 2 MENU →  /  (Shooting) → [Shooting Mode] → [ Shoot Mode]/[ Shoot Mode]/[ Shoot Mode] → [Aperture Priority].**
- 3 Select the desired value by turning the control wheel.**
 - Smaller F-value: The subject is in focus, but objects in front of and beyond the subject are blurred.
Larger F-value: The subject and its foreground and background are all in focus.
 - If the aperture value you have set is not suitable for appropriate exposure, the shutter speed on the shooting screen will blink. If this happens, change the aperture value.
- 4 Adjust the focus and shoot the subject.**

The shutter speed is automatically adjusted to obtain proper exposure.

Note

- The brightness of the image on the screen may differ from the actual image being shot.
- Depending on the position of the optical zoom, the aperture value setting range is as follows.
 - W: F1.8 - F9.0
 - T: F4.0 - F11

Shoot Mode: Shutter Priority



By adjusting the shutter speed, you can shoot still images with different effects for moving objects, or record movies with natural movement.

- 1 Press the Still/Movie/S&Q button to select the desired shooting mode.**
- 2 MENU** → / (Shooting) → [Shooting Mode] → [Shoot Mode]/[Shoot Mode]/[Shoot Mode] → [Shutter Priority].
- 3 Select the desired value by turning the control wheel.**
 - If proper exposure cannot be obtained after setup, the aperture value on the shooting screen blinks. If this happens, change the shutter speed.
- 4 Adjust the focus and shoot the subject.**

The aperture is automatically adjusted to obtain proper exposure.

Hint

- Use a tripod to prevent camera-shake when you have selected a slow shutter speed.
- When you shoot indoor sports scenes, set the ISO sensitivity to a higher value.

Note

- The SteadyShot warning indicator does not appear in [Shutter Priority] mode.
- The brightness of the image on the screen may differ from the actual image being shot.

Shoot Mode: Manual Exposure



You can shoot with the desired exposure setting by adjusting both the shutter speed and aperture.

- 1 Press the Still/Movie/S&Q button to select the desired shooting mode.
- 2 MENU → / (Shooting) → [Shooting Mode] → [Shoot Mode]/[Shoot Mode]/[Shoot Mode] → [Manual Exposure].
- 3 Press the down side of the control wheel to select the shutter speed or aperture value, then turn the control wheel to select a value.
 - You can also set [ISO] to [ISO AUTO] in manual exposure mode. The ISO value automatically changes to achieve the appropriate exposure using the aperture value and shutter speed you have set.
 - When [ISO] is set to [ISO AUTO], the ISO value indicator will blink if the value you have set is not suitable for appropriate exposure. If this happens, change the shutter speed or aperture value.
 - When [ISO] is set to other than [ISO AUTO], use MM (Metered Manual)* to check the exposure value.
Toward +: Images become brighter.
Toward -: Images become darker.
0: Appropriate exposure analyzed by the camera.

* Indicates under/over for appropriate exposure.
- 4 Adjust the focus and shoot the subject.

Hint

- You can change the shutter speed and aperture (F-value) combination without changing the set exposure value (Manual shift). Assign [AEL hold] or [AEL toggle] to a desired key using the custom key settings, and then turn the control wheel while pressing that key.

Note

- The Metered Manual indicator does not appear when [ISO] is set to [ISO AUTO].
- When the amount of ambient light exceeds the metering range of the Metered Manual, the Metered Manual indicator flashes.
- The SteadyShot warning indicator does not appear in manual exposure mode.
- The brightness of the image on the screen may differ from the actual image being shot.
- You cannot set [ND Filter] to [Auto].

Related Topic

- [ISO \(still image/movie\)](#)



Digital Camera
ZV-1M2

Product Showcase Set





The camera settings are optimally configured for situations such as movie shooting for product reviews. The camera tends to focus on objects that are closer to it.

1 Press  (Product Showcase Set) button to switch the [Product Showcase Set] function on or off.

You can also switch the [Product Showcase Set] function on or off by selecting MENU →  /  (Shooting) → [Shooting Option].

Menu item details

On:
Shoots with optimal settings for product reviews. [ Subject Recog in AF] under [Subject Recognition] is locked to [Off], and [ Focus Area] is set to [Zone].

Off:
Shoots in the ordinary shooting mode.

Note

- Settings for [Product Showcase Set] cannot be changed during movie recording.

Background Defocus







You can change the level of defocus in the background simply by pressing the button while shooting still images or movies.

1 Press the (Background Defocus) button repeatedly.



Once you press the button, the [Background Defocus] mode is activated, and the background becomes defocused. Afterwards, the level of defocus in the background switches between “Defocus” and “Clear” each time you press the button.

- The camera returns to the normal shooting mode and the aperture returns to the former value when you press the Still/Movie/S&Q button.

Hint

- The aperture value becomes locked and the icon  (Defocus) or  (Clear) is indicated instead of the aperture value in the [Background Defocus] mode. The aperture value is locked at wide open when  (Defocus) is indicated. The aperture value is locked at F5.6 when  (Clear) is indicated.

Note

- [Background Defocus] mode is canceled, the camera returns to normal shooting mode, and the aperture returns to the former value when you perform the following operations:
 - Turning the power off and back on again
 - Pressing the Still/Movie/S&Q button
 - Pressing the MENU button
 - Changing the aperture value while the shooting mode is set to [Aperture Priority] or [Manual Exposure]
 -  Exposure Comp.
 - Performing Program Shift or Manual Shift
- Even if you press the button, you cannot change the level of defocus while using [ Set Focus] or [Focus Magnifier] in the [Background Defocus] mode.
- Depending on the shooting mode and shooting conditions, the camera may be unable to obtain the optimal exposure due to the locking of the aperture value in the [Background Defocus] mode.

Cinematic Vlog Set.



You can easily shoot cinematic images. When [Cinematic Vlog Set.] is set to [On], black bars are added at the top and bottom of the image, and the frame rate is locked to 24 fps.

- 1 MENU → (Shooting) → [Shooting Option] → [Cinematic Vlog Set.] → desired setting.
 - When [On] is selected, you can configure detailed settings for the effect by pressing the right side of the control wheel.

Menu item details

On:
Shoots images using the cinematic vlog effect. You can configure detailed settings for [Look]/[Mood]/[AF Transition Speed].

Off:
Does not use the cinematic vlog effect.

Settings for cinematic vlog

[Look], [Mood], and [AF Transition Speed] can be set according to the image to be shot.

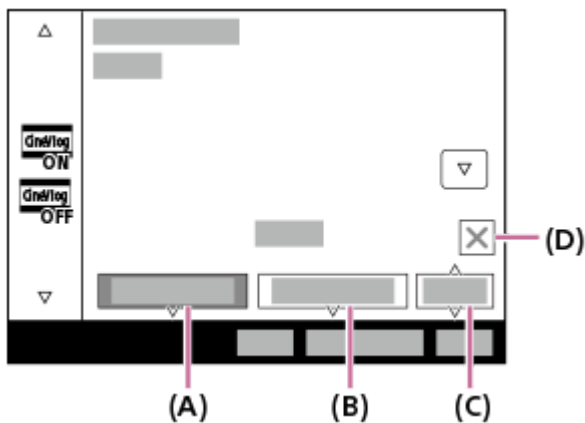

- (A): Look
(B): Mood
(C): AF Transition Speed
(D): Close icon

- Touch the Close icon to hide the [Look], [Mood], and [AF Transition Speed] submenus. After hiding them, you can redisplay the submenus by holding down the (Cinematic Vlog) icon.

Look:

Select the finish of the image from presets that have varied contrast, saturation, etc.

CLASSIC:

Creates an image with a cinematic look.

CLEAN:

Creates images with a refreshing look.

CHIC:

Creates images with a profound look.

FRESH:

Creates images with a colorful look.

MONO:

Creates images with a black and white look.

Mood:

Select the color tone of the image from presets according to the color you want to emphasize. [Mood] cannot be selected when [Look] is set to [MONO].

AUTO:

Creates images with colors optimal for the environment.

GOLD:

Creates images with warm colors.

OCEAN:

Creates images with cool colors.

FOREST:

Creates images with nostalgic colors.

AF Transition Speed:

Sets the focusing speed when the target of the auto focus is switched or moving.

HI:

Sets a fast switching speed of focusing to focus on the subject rapidly.

MID:

Sets a normal switching speed of focusing.



LO:

Sets a slow switching speed of focusing to focus on the subject smoothly.

Hint

- By shooting images with the same [Look] and [Mood] throughout the work, you can create a sense of unity in your work.

Note

- The black bars at the top and bottom of the screen are recorded as part of the image. The image area excluding the black bars at the top and bottom of the screen has the aspect ratio of the cinema scope size, but the aspect ratio of the recorded image is 16:9.
- When [Cinematic Vlog Set.] is set to [On], [AF Transition Speed] under [AF/MF] becomes temporarily invalid.
- When [Cinematic Vlog Set.] is set to [On], [ White Balance] becomes locked to [Auto], and the color tone changes according to the setting for [Mood].
- If you press the MOVIE (movie) button in the still image shooting mode to record a movie, the [Cinematic Vlog Set.] setting will not be reflected in the movie.
- When [Cinematic Vlog Set.] is set to [On], [ Proxy Settings] is disabled.



Self-timer (movie)



You can start shooting with the self-timer when recording a movie.

1 Press  /  (Drive Mode) of the control wheel.

The [ Self-timer] setting screen will be displayed.

- You can also set the drive mode by selecting MENU →  (Shooting) → [Shooting Option] → [ Self-timer].

2 Select [On] using the control wheel and set the desired countdown time.

- Rec Start delay: Sets the count time until the start of movie recording. (3 s/5 s/10 s)
- Repetition: Sets whether to repeat the movie self-timer. (Repeat/Only Once)
If you select [Repeat], the movie self-timer will be activated repeatedly even after movie recording is completed.
If you select [Only Once], the movie self-timer will be canceled after movie recording is completed, and the camera will return to the normal movie recording standby mode.

3 Adjust the focus and press the MOVIE (movie) button.

When the countdown appears on the recording standby screen, the self-timer lamp flashes, a beep sounds, and recording starts after the designated number of seconds has elapsed.

- Press the MOVIE button again to end recording.

Menu item details

On:

Uses the movie self-timer function.

Off:

Does not use the movie self-timer function.

Hint

- To stop the self-timer countdown, press the MOVIE button again or press the button to which the [ Self-timer] function is assigned.

Note

- If you press the MOVIE button in the still image shooting mode to start movie recording, [ Self-timer] will not work.

Digital Camera
ZV-1M2

Selecting the focus method (Focus Mode)



Selects the focus method to suit the movement of the subject.

① MENU → AF_{MF} (Focus) → [AF/MF] → [📷 Focus Mode] → desired setting.

Menu item details

AF-S Single-shot AF:

The product locks the focus once focusing is complete. Use this when the subject is motionless.

AF-A Automatic AF:

[Single-shot AF] and [Continuous AF] are switched according to the movement of the subject. When the shutter button is pressed halfway down, the product locks the focus when it determines that the subject is motionless, or continues to focus when the subject is in motion. During continuous shooting, the product automatically shoots with [Continuous AF] from the second shot.

AF-C Continuous AF:

The product continues to focus while the shutter button is pressed and held halfway down. Use this when the subject is in motion. In [Continuous AF] mode, there is no beep when the camera focuses.

DMF DMF:

You can make fine adjustments manually after performing auto focusing, letting you focus on a subject more quickly than when using [Manual Focus] from the beginning. This is convenient in situations such as macro shooting.

MF Manual Focus:

Adjusts the focus manually. If you cannot focus on the intended subject using auto focus, use [Manual Focus].

Focus indicator

● (lit):

The subject is in focus and the focus is locked.

● (flashing):

The subject is not in focus.

⊙ (lit):

The subject is in focus. The focus will be adjusted continuously according to the movements of the subject.

⊕ (lit):

Focusing is in progress.

Subjects on which it is difficult to focus using auto focus

- Dark and distant subjects
- Subjects with poor contrast
- Subjects seen through glass
- Fast-moving subjects
- Reflective light or shiny surfaces
- Flashing light

- Back-lit subjects
- Continuously repetitive patterns, such as the facades of buildings
- Subjects in the focusing area with different focal distances

Hint

- When you set the focus to infinity in [Manual Focus] mode or [DMF] mode, make sure that the focus is on a sufficiently distant subject by checking the monitor.

Note

- Only [Continuous AF] and [Manual Focus] are available in the movie shooting mode.

Related Topic

- [Direct manual focus \(DMF\)](#)
- [Manual Focus \(Set Focus\)](#)
- [Selecting the focus area \(Focus Area\)](#)
- [Assigning frequently used functions to buttons \(Custom Key Setting\)](#)

5-049-603-11(1) Copyright 2023 Sony Corporation

Selecting the focus area (Focus Area)



Set the type of focusing frame when shooting with the auto focus. Select the mode according to the subject.

1 MENU → AF_{MF} (Focus) → [Focus Area] → [Focus Area] → desired setting.

Menu item details

Wide:

Focuses on a subject covering the whole range of the screen automatically. When you press the shutter button halfway down in the still image shooting mode, a green frame is displayed around the area that is in focus.

Zone:

Select a zone on the monitor on which to focus, and the product will automatically select a focus area.

Center Fix:

Focuses automatically on a subject in the center of the image. Use together with the focus-lock function to create the composition you want.

Spot: S/Spot: M/Spot: L:

Allows you to move the focusing frame to a desired point on the screen and focus on an extremely small subject in a narrow area.

Expand Spot:

If the product cannot focus on a single selected point, it uses focus points around the [Spot] as a secondary priority area for focusing.

Tracking:

This setting is available only when the [Focus Mode] is set to [Continuous AF]. When the shutter button is pressed and held halfway down, the product tracks the subject within the selected autofocus area. Point the cursor at [Tracking] on the [Focus Area] setting screen, and then select the desired area to start tracking using the left/right sides of the control wheel. You can also move the tracking start area to the desired point by designating the area as a [Tracking: Zone], [Tracking: Spot S]/[Tracking: Spot M]/[Tracking: Spot L] or [Tracking: Expand Spot].

Note

- [Focus Area] is locked to [Wide] in the following situations:
 - [Scene Selection]
- The focus area may not light up during continuous shooting or when the shutter button is pressed all the way down at once.
- When the shooting mode is set to [Movie] or [S&Q Motion] or during movie shooting, [Tracking] cannot be selected for [Focus Area].

Examples of the focusing frame display

The focusing frame differs as follows.

When focusing on a larger area

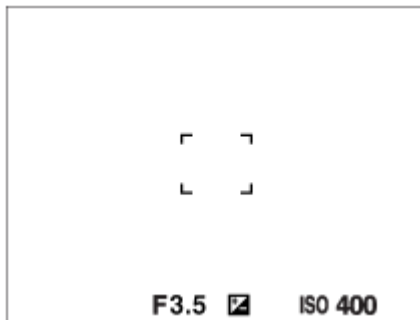

When focusing on a smaller area

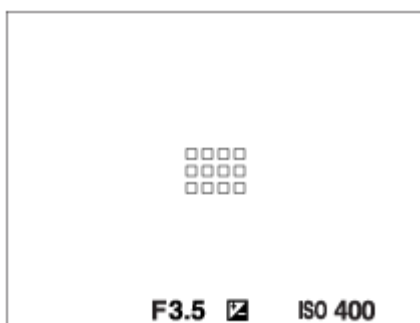

- When [Focus Area] is set to [Wide] or [Zone], the focusing frame may switch between “When focusing on a larger area” and “When focusing on a smaller area” depending on the subject or situation.

When focus is achieved automatically based on the whole range of the monitor

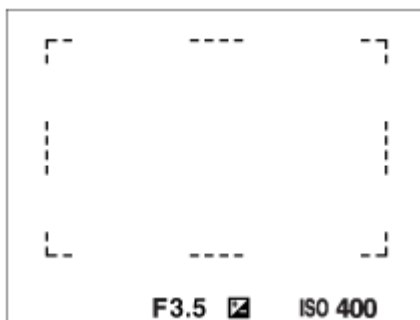

- When you use a zoom function other than the optical zoom in the still image shooting mode, the [Focus Area] setting is disabled and the focusing frame is shown by the dotted line. The AF operates with priority on and around the center area.

To move the focus area

- When [Focus Area] is set to [Zone], [Spot] or [Expand Spot], if pressing the button to which [Focus Standard] is assigned, you can shoot while moving the focusing frame using the top/bottom/left/right sides of the control wheel. To return the focusing frame to the center of the monitor, press the  (Delete) button while moving the frame. To change the shooting settings using the control wheel, press the button to which [Focus Standard] is assigned.

Hint

- You can move the focusing frame quickly by touching and dragging it on the monitor. Set [Touch Operation] to [On], and set [Touch Func. in Shooting] under [Shooting Screen] to [Touch Focus] beforehand.

Note

- You cannot execute functions assigned to the control wheel or the  (Product Showcase Set) button while moving the focusing frame.

Phase detection AF

When there are phase detection AF points within the auto focus area, the product uses the combined autofocus of the phase detection AF and contrast AF.

Note

- When the F-value is greater than F8, you cannot use the Phase Detection AF. Only Contrast AF is available.
- When [▶■ File Format] is set to [XAVC S HD] and [Rec Frame Rate] under [▶■ Movie Settings] is set to [120p]/[100p], Phase Detection AF cannot be used. Only Contrast AF is available.

Related Topic

- [Selecting the focus method \(Focus Mode\)](#)
- [Touch Operation](#)
- [Shooting Screen](#)
- [Focusing using touch operations \(Touch Focus\)](#)

Digital Camera
ZV-1M2

Tracking subject (Tracking function)

This camera has the function of tracking which tracks the subject, and keeps marking it with the focusing frame. You can set the start position to track by selecting from focusing areas, or by specifying by touch operation. The required function varies depending on the setting method.

- You can refer to the related functions under “Related Topic” at the bottom of this page.

Setting the start position to track by focusing area ([Tracking] under [Focus Area])

The selected focusing frame is set as the start position to track, and the tracking starts by pressing the shutter button halfway down.

- This function is available in still image shooting mode.
- This function is available when [ Focus Mode] is set to [Continuous AF].

Setting the start position to track by touch operation ([Touch Tracking] under [Touch Func. in Shooting])

You can set the subject to track by touching it on the monitor.

- This function is available in still image shooting mode and movie shooting mode.
- This function is available when [ Focus Mode] is set to [Single-shot AF], [Automatic AF] or [Continuous AF].

Related Topic

- [Selecting the focus method \(Focus Mode\)](#)
- [Selecting the focus area \(Focus Area\)](#)
- [Starting tracking with touch operations \(Touch Tracking\)](#)

Manual Focus (Set Focus)



When it is difficult to focus properly in the autofocus mode, you can adjust the focus manually.

1 MENU → AF_{MF} (Focus) → [AF/MF] → [Focus Mode] → [Manual Focus].





2 MENU → AF_{MF} (Focus) → [AF/MF] → [ Set Focus].

The screen for manual focusing operations will appear.

3 Press the left/right side of the control wheel or turn the control wheel to adjust the focus.

- The focus distance will be displayed on the screen.
- To enable fine adjustments to the focus under various conditions, the focusing indicator can be moved beyond infinity. When you want to focus at infinity, do not move the indicator to the end of the bar. Instead, adjust the focus while checking the monitor.
- To return to the shooting screen, press the center of the control wheel.

Hint

- Using [ Auto Magnifier in MF] allows you to manually focus more easily because the image is automatically enlarged during manual focus adjustments. While the magnified image is displayed, you can use the top/bottom/left/right side of the control wheel to adjust which part of the image to magnify. Turn the control wheel to adjust the focus.
- When you use [ Peaking Display], the outlines of in-focus ranges are enhanced using a specific color. This function allows you to check the focus easily.
- The screen for manual focusing operations can be displayed when shooting in the manual focusing mode by pressing the key to which you assigned [Focus Standard] using [ Custom Key Setting] or [ Custom Key Setting].

Note

- Manually set focus distances are canceled when [ Focus Mode] is reselected.
- The displayed focus distance is just a reference.

Related Topic

- [Direct manual focus \(DMF\)](#)
- [Auto Magnifier in MF \(still image/movie\)](#)
- [Focus Magnifier](#)
- [Peaking Display](#)

Direct manual focus (DMF)



You can make fine adjustments manually after performing auto focusing, letting you focus on a subject more quickly than when using the manual focus from the beginning. This is convenient in situations such as macro shooting.

1 MENU → AF_{MF} (Focus) → [AF/MF] → [Focus Mode] → [DMF].

2 Press the shutter button halfway down to focus automatically.

3 MENU → AF_{MF} (Focus) → [AF/MF] → [Set Focus].

The screen for manual focusing operations will appear.

- The screen for manual focusing operations can also be displayed by pressing the key to which [Focus Standard] has been assigned using [Custom Key Setting] or [Custom Key Setting].

4 Press the left/right side of the control wheel or turn the control wheel to adjust the focus.

- The focus distance will be displayed on the screen.
- To enable fine adjustments to the focus under various conditions, the focusing indicator can be moved beyond infinity. When you want to focus at infinity, do not move the indicator to the end of the bar. Instead, adjust the focus while checking the monitor, etc.
- To return to the shooting screen, press the center of the control wheel.

5 Press the shutter button fully down to shoot an image.

Related Topic











- [Manual Focus \(Set Focus\)](#)
- [Peaking Display](#)

Focusing on human eyes

The camera can automatically recognize faces and eyes and focus on the eyes.

The following explanation is for cases where the recognition target is human. The faces of up to 8 subjects can be recognized.

There are two methods of focusing on eyes, with some differences between their specifications. Select the appropriate method according to your purpose.





Item	[ Subject Recog in AF] function	[Subject Recognition AF] via a custom key
Characteristics	The camera will recognize faces/eyes with greater priority.	The camera will recognize faces/eyes exclusively.
Advance preparation	<ul style="list-style-type: none"> Select [ Subject Recog in AF] → [On]. Select [ Recognition Target] → [Human]. 	Assign [Subject Recognition AF] to the desired key using [ Custom Key Setting].
How to focus	Press the shutter button halfway down.	Press the key to which you have assigned the [Subject Recognition AF] function.*
Function details	<ul style="list-style-type: none"> When the camera recognizes a face or eye inside or around the designated [ Focus Area], it focuses on the face or eye with greater priority. If the camera does not recognize any faces or eyes inside or around the designated [ Focus Area], it will focus on another subject. 	<ul style="list-style-type: none"> The camera focuses exclusively on faces or eyes anywhere on the screen, regardless of the setting for [ Focus Area]. The camera will not automatically focus on another subject if no face or eye is recognized anywhere on the screen.
Focus mode	Follows the setting designated with [ Focus Mode]	Follows the setting designated with [ Focus Mode]
Focus area	Follows the setting designated with [ Focus Area]	The focus area temporarily becomes the entire screen, regardless of the setting for [ Focus Area].

* Regardless of whether [ Subject Recog in AF] is set to [On] or [Off], you have assigned [Subject Recognition AF] to a custom key, you can use [Subject Recognition AF] while you are pressing that custom key.

[Subject Recognition AF] by custom key

This function can be used by assigning [Subject Recognition AF] to a custom key. The camera can focus on eyes as long as you are pressing the key. This is useful when you want to temporarily perform auto-focusing anywhere on the entire screen regardless of the setting for [ Focus Area].

If the camera does not recognize any faces or eyes, auto-focusing will not be performed.

- MENU →  (Setup) → [Operation Customize] → [ Custom Key Setting] → desired key, then assign the [Subject Recognition AF] function to the key.
- MENU →  (Focus) → [Subject Recognition] → [ Recognition Target] → [Human].

3. Point the camera at the face of a human, and press the key to which you have assigned the [Subject Recognition AF] function.

Press the shutter button while pressing the key.

To focus on the eyes of an animal

Set [ Recognition Target] to [Animal] before shooting.

Hint











- Setting [ Sbj Recog Frm Disp.] to [On] makes it easier to check the detection status of faces or eyes.

Note

- It may be difficult to focus on eyes in the following situations:

- When the person is wearing sunglasses.
- When the front hair covers the person's eyes.
- In low-light or back-lit conditions.
- When the eyes are closed.
- When the subject is in the shade.
- When the subject is out of focus.
- When the subject is moving too much

There are also other situations in which it may not be possible to focus on the eyes.

- When the camera cannot focus on human eyes, it will recognize and focus on a face instead. The camera cannot focus on eyes when no human faces are recognized.
- The camera may not recognize faces at all or may accidentally recognize other objects as faces under some conditions.
- The camera cannot recognize faces or eyes in the following situations:
 - When using zoom functions other than the optical zoom
- The camera cannot recognize faces in the following situations when shooting movies:
 - When [ File Format] is set to [XAVC S 4K] and [ Proxy Recording] under [ Proxy Settings] is set to [On]
 - When [ File Format] is set to [XAVC S 4K], [Rec Frame Rate] under [ Movie Settings] is set to [30p], and [Rec. Media dur HDMI Output] under [ HDMI Output Settings] is set to [On]
 - When [ File Format] is set to [XAVC S 4K] and connecting to the camera from a computer, etc.
 - When [ File Format] is set to [XAVC S 4K], and you are performing remote shooting via a smartphone
 - When [ File Format] is set to [XAVC S HD] and [Rec Frame Rate] under [ Movie Settings] is set to [120p]/[100p]

Related Topic

- [Subject Recog in AF \(still image/movie\)](#)
- [Recognition Target \(still image/movie\)](#)
- [Right/Left Eye Select \(still image/movie\)](#)
- [Sbj Recog Frm Disp. \(still image/movie\)](#)
- [Selecting the focus method \(Focus Mode\)](#)
- [Selecting the focus area \(Focus Area\)](#)

Subject Recog in AF (still image/movie)



Sets whether or not the camera recognizes faces or eyes inside the focus area while performing autofocus, and then focuses on the eyes automatically.

1 MENU → AF_{MF} (Focus) → [Subject Recognition] → [👤 Subject Recog in AF] → desired setting.

Menu item details

On:

Focuses on the faces or eyes with priority if there are faces or eyes which the camera can recognize inside or around the designated focus area.

Off:

Does not prioritize faces or eyes when performing auto-focusing.

Hint

- When [👤 Subject Recog in AF] is assigned to the desired key using [📷 Custom Key Setting] or [▶ Custom Key Setting], you can switch the [👤 Subject Recog in AF] function on or off by pressing the key.

Note

- If the camera does not recognize any faces or eyes inside or around the designated focus area, it will focus on another subject.

Related Topic

- [Focusing on human eyes](#)
- [Recognition Target \(still image/movie\)](#)
- [Right/Left Eye Select \(still image/movie\)](#)
- [Assigning frequently used functions to buttons \(Custom Key Setting\)](#)

Recognition Target (still image/movie)



Selects the target to be recognized with the [ Subject Recog in AF] function.

① MENU → AF_{MF} (Focus) → [Subject Recognition] → [ Recognition Target] → desired setting.

Menu item details

Human:

Recognizes human faces/eyes.





Animal:

Recognizes animal eyes.

Hint

- To make the camera recognize animal eyes, compose the shot so that the animal's eyes and nose are within the angle of view. Once you focus on the animal's face, it will be easier to recognize the animal's eyes.

Note

- When [ Recognition Target] is set to [Animal], the following functions cannot be used.
 -  Face Priority in Multi Metering
 -  Regist. Faces Priority
- Even when [ Recognition Target] is set to [Animal], the eyes of some types of animals cannot be recognized.

Related Topic

- [Focusing on human eyes](#)
- [Subject Recog in AF \(still image/movie\)](#)

Right/Left Eye Select (still image/movie)



Sets whether to focus on the left or right eye when the camera recognizes human eyes.

① MENU → AF_{MF} (Focus) → [Subject Recognition] → [Right/Left Eye Select] → desired setting.

Menu item details

Auto:

The camera automatically selects either the left eye or right eye.

Right Eye:

The right eye of the subject (the eye on the left side from the photographer's perspective) is selected.

Left Eye:

The left eye of the subject (the eye on the right side from the photographer's perspective) is selected.

[Switch Right/Left Eye] by custom key

You can also switch between the right eye and left eye to focus with the custom key.

When [Right/Left Eye Select] is set to [Right Eye] or [Left Eye], you can switch the eye to be focused by pressing the custom key to which you have assigned the [Switch Right/Left Eye] function.

When [Right/Left Eye Select] is set to [Auto], you can temporarily switch the eye to be focused by pressing the custom key to which you have assigned the [Switch Right/Left Eye] function.

The temporary left/right selection is canceled when you perform the following operations, etc. The camera returns to automatic eye selection.

- Pressing the center of the control wheel
- Stopping pressing the shutter button halfway down (only during still image shooting)
- Stopping pressing the custom key to which [Subject Recognition AF] is assigned (only during still image shooting)
- Pressing the MENU button

Hint

- When [Sbj Recog Frm Disp.] is set to [On], the eye recognition frame appears around the eye you selected using [Right/Left Eye Select] or [Switch Right/Left Eye] with the custom key.

Related Topic

- [Focusing on human eyes](#)
- [Subject Recog in AF \(still image/movie\)](#)
- [Recognition Target \(still image/movie\)](#)
- [Sbj Recog Frm Disp. \(still image/movie\)](#)

Digital Camera
ZV-1M2

Sbj Recog Frm Disp. (still image/movie)



Sets whether to display the subject recognition frame when faces or eyes are recognized.

① MENU → AF_{MF} (Focus) → [Subject Recognition] → [Sbj Recog Frm Disp.] → desired setting.

Menu item details

On:

Displays a recognition frame when faces or eyes are recognized.

Off:

Does not display a recognition frame when faces or eyes are recognized.

Face recognition frame

When the camera recognizes a face, the gray face-recognition frame appears. The frame color will be reddish purple if the recognized face has been registered using the [Face Memory] function.

The face recognition frame turns white when the face is recognized inside or around the focus area, and the camera determines that autofocus is enabled.

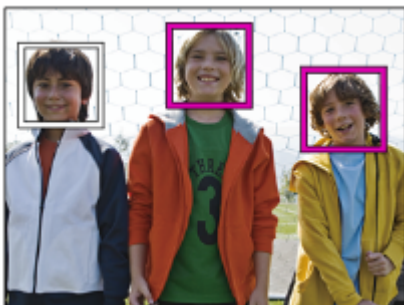

Eye recognition frame

A white eye recognition frame appears when an eye is recognized and the camera determines that auto-focusing is possible.

The eye recognition frame is displayed as follows when [Recognition Target] is set to [Animal].



Note

- If the subject is moving too much or too fast, the recognition frame may not be displayed correctly over their eyes.
- If the eyes are not recognized, the eye recognition frame will not be displayed.
- Even if [ Sbj Recog Frm Disp.] is set to [Off], a green focusing frame will appear over faces or eyes that are in focus when you press the shutter button halfway down, etc.

Related Topic

- [Focusing on human eyes](#)
- [Subject Recog in AF \(still image/movie\)](#)
- [Recognition Target \(still image/movie\)](#)
- [Right/Left Eye Select \(still image/movie\)](#)
- [Face Memory](#)

5-049-603-11(1) Copyright 2023 Sony Corporation

Digital Camera
ZV-1M2

Face Memory



Sets personal face data. If you register faces in advance, the product can focus on the registered face as a priority. Up to eight faces can be registered.

1 MENU → AF_{MF} (Focus) → [Subject Recognition] → [Face Memory] → desired setting item.

Menu item details

New Registration:

Shoots and registers faces.

Order Exchanging:

When multiple faces are registered, the order of priority for the registered face data can be changed.

Delete:

Deletes registered faces one by one.

Delete All:

Deletes all registered faces at once.

Note

- When performing [New Registration], shoot the face from the front in a brightly lit place. The face may not be registered correctly if it is obscured by a hat, a mask, sunglasses, etc.
- Even if you execute [Delete], the data for registered face will remain in the product. To delete the data for registered faces from the product, select [Delete All].

Related Topic

- [Regist. Faces Priority \(still image/movie\)](#)

Regist. Faces Priority (still image/movie)



Sets whether to focus with higher priority on faces registered using [Face Memory].

① MENU → AF_{MF} (Focus) → [Subject Recognition] → [Regist. Faces Priority] → desired setting.

Menu item details

On:

Focuses with higher priority on faces registered using [Face Memory].

Off:

Focuses without giving higher priority to registered faces.

Hint

- To use the [Regist. Faces Priority] function, set as follows.
 - [Subject Recog in AF] under [Subject Recognition]: [On]
 - [Recognition Target] under [Subject Recognition]: [Human]

Related Topic

- [Subject Recog in AF \(still image/movie\)](#)
- [Recognition Target \(still image/movie\)](#)
- [Face Memory](#)

Focus Standard



If you press the key to which [Focus Standard] is assigned, you can recall useful functions such as moving the focusing frame quickly, etc. depending on the focus area settings.

- 1 **MENU** → (Setup) → [Operation Customize] → [Custom Key Setting] or [Custom Key Setting] → desired key, then assign the [Focus Standard] function to the key.
- 2 **Press the key to which [Focus Standard] is assigned.**
 - What you can do by pressing the key varies depending on the setting for [Focus Area].

Examples of [Focus Standard] key functions

- When [Focus Area] is set to any of the following parameters, pressing the key enables you to move the focusing frame using the top/bottom/left/right side of the control wheel.
 - [Zone]
 - [Spot: S]/[Spot: M]/[Spot: L]
 - [Expand Spot]
 - [Tracking: Zone]
 - [Tracking: Spot S]/[Tracking: Spot M]/[Tracking: Spot L]
 - [Tracking: Expand Spot]
- When [Focus Area] is set to [Wide], [Center Fix], [Tracking: Wide], or [Tracking: Center Fix], pressing the key in the autofocus mode makes the camera focus on the center of the screen.

Hint

- If you press the key to which [Focus Standard] is assigned when [Focus Mode] is set to [Manual Focus], the screen for manual focusing operations will appear.

Note

- You cannot set the [Focus Standard] function to [Left Button] or [Right Button].

Related Topic

- [Assigning frequently used functions to buttons \(Custom Key Setting\)](#)
- [Selecting the focus area \(Focus Area\)](#)

Focus Area Limit (still image/movie)



By limiting the types of available focus area settings in advance, you can more quickly select settings for [Focus Area].

- 1 **MENU** → **AF_{MF} (Focus)** → [**Focus Area**] → [**Focus Area Limit**] → **Add check marks to the focus areas that you want to use, and then select [OK].**

The types of focus areas marked with (check mark) will be available as settings.

Note

- Types of focus areas that do not have a check mark cannot be selected using MENU or the Fn (function) menu. To select one, add a check mark using [Focus Area Limit].

Related Topic

- [Selecting the focus area \(Focus Area\)](#)
- [Assigning frequently used functions to buttons \(Custom Key Setting\)](#)

Circ. of Focus Point (still image/movie)



Sets whether to allow the focusing frame to jump from one end to the other when you move the focusing frame. This function is useful when you want to move the focusing frame from one end to the other quickly.

The function can be used when the following settings are selected for [Focus Area].

- [Zone]
- [Spot: S]/[Spot: M]/[Spot: L]
- [Expand Spot]
- [Tracking: Zone]
- [Tracking: Spot S]/[Tracking: Spot M]/[Tracking: Spot L]
- [Tracking: Expand Spot]

1 MENU → AF_{MF} (Focus) → [Focus Area] → [Circ. of Focus Point] → desired setting.

When [Circulate] is selected:

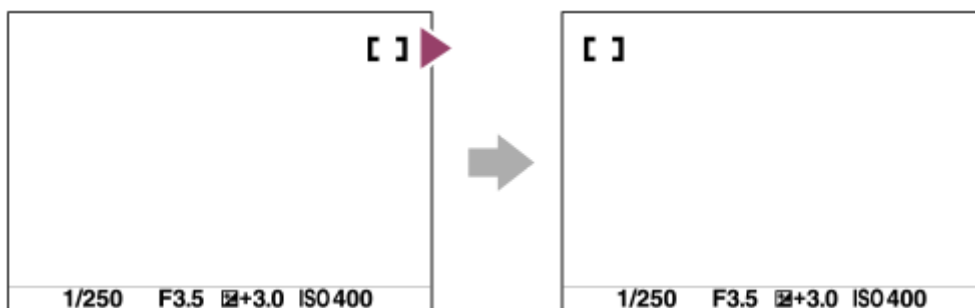

Menu item details

Does Not Circulate:

The cursor does not move when you try to move the focusing frame past the end.

Circulate:

The cursor jumps to the opposite end when you try to move the focusing frame past the end.

Related Topic

- [Selecting the focus area \(Focus Area\)](#)

Digital Camera
ZV-1M2

Focus Area Color (still image/movie)



You can specify the color of the frame indicating the focusing area. If the frame is difficult to see because of the subject, make it more visible by changing its color.

① MENU → AF_{MF} (Focus) → [Focus Area] → [📷 Focus Area Color] → desired color.

Menu item details

White:

Displays the frame indicating the focusing area in white.

Red:

Displays the frame indicating the focusing area in red.

Related Topic

- [Selecting the focus area \(Focus Area\)](#)

AF Area Auto Clear



Sets whether the focus area is displayed all the time or disappears automatically shortly after focus is achieved.

① MENU → AF_{MF} (Focus) → [Focus Area] → [AF Area Auto Clear] → desired setting.

Menu item details

On:

The focus area disappears automatically shortly after focus is achieved.

Off:



The focus area is displayed all the time.

Related Topic

- [Selecting the focus area \(Focus Area\)](#)

AF-C Area Display



You can set whether or not to display the area that is in focus when [ Focus Mode] is set to [Continuous AF] and [ Focus Area] is set to [Wide] or [Zone].

1 MENU → AF_{MF} (Focus) → [Focus Area] → [AF-C Area Display] → desired setting.

Menu item details

On:

Displays the focus area that is in focus.

Off:

Does not display the focus area that is in focus.

Note

- When [ Focus Area] is set to one of the following, the focusing frames in the area that is in focus turn green:
 - [Center Fix]
 - [Spot]
 - [Expand Spot]

Related Topic

- [Selecting the focus area \(Focus Area\)](#)

Digital Camera
ZV-1M2

Phase Detect. Area



Sets whether or not to display the Phase Detection AF area.

① MENU → AF_{MF} (Focus) → [Focus Area] → [Phase Detect. Area] → desired setting.

Menu item details

On:

Displays the Phase Detection AF area.

Off:

Does not display the Phase Detection AF area.

Note

- When the F-value is larger than F8, Phase Detection AF cannot be used. Only Contrast AF is available.
- When recording movies, the Phase Detection AF area will not be displayed.

AF Transition Speed



Sets the focusing speed when the target of the auto focus is switched during movie shooting.

① MENU → AF_{MF} (Focus) → [AF/MF] → [AF Transition Speed] → **desired setting.**

Menu item details

7 (Fast)/6/5/4/3/2/1 (Slow):

Select a faster value to focus on the subject more quickly.

Select a slower value to focus on the subject more smoothly.

Hint

- You can use the touch focus function to intentionally transition the AF.

Digital Camera
ZV-1M2

AF Subj. Shift Sensitivity



Sets the sensitivity with which the focus switches to another subject when the original subject leaves the focus area or an unfocused subject in the foreground approaches the center of the focus area during movie shooting.

1 MENU → AF_{MF} (Focus) → [AF/MF] → [AF Subj. Shift Sensitivity] → **desired setting.**

Menu item details

5(Responsive)/4/3/2/1(Locked on):

Select a higher value when you want to shoot a quick-moving subject, or when you want to shoot multiple subjects while switching the focus continually.

Select a lower value when you want the focus to remain steady, or when you want to keep the focus on a particular target without being affected by other subjects.

Digital Camera
ZV-1M2

AF/MF Selector



You can easily switch the focusing mode from auto to manual and vice versa while shooting without changing your holding position.

- 1 MENU →  (Setup) → [Operation Customize] → [ Custom Key Setting] or [ Custom Key Setting] → desired button → [AF/MF Selector Hold] or [AF/MF Selector Toggle].

Menu item details

AF/MF Selector Hold:

Switches the focusing mode while the button is held down.

AF/MF Selector Toggle:

Switches the focusing mode until the button is pressed again.

Note

- You cannot set the [AF/MF Control Hold] function to [Left Button] or [Right Button] of the control wheel.

Related Topic

- [Assigning frequently used functions to buttons \(Custom Key Setting\)](#)

Pre-AF



The product automatically adjusts focus before you press the shutter button halfway down.

① MENU → AF_{MF} (Focus) → [AF/MF] → [Pre-AF] → **desired setting.**

Menu item details

On:

Adjusts focus before you press the shutter button halfway down.

Off:

Does not adjust focus before you press the shutter button halfway down.



Note

- During focusing operations, the screen may shake.

Auto Magnifier in MF (still image/movie)



Enlarges the image on the screen automatically to make manual focusing easier. This works in Manual Focus or Direct Manual Focus shooting.

- 1 MENU → AF_{MF} (Focus) → [Focus Assistant] → [ Auto Magnifier in MF] → [On].
- 2 MENU → AF_{MF} (Focus) → [ Set Focus] → Adjust the focus using the top/bottom/left/right side of the control wheel.
 - The image is enlarged.

Hint

- You can set how long the image is to be shown magnified by selecting MENU → AF_{MF} (Focus) → [Focus Assistant] → [ Focus Magnif. Time].

Related Topic





- [Manual Focus \(Set Focus\)](#)
- [Direct manual focus \(DMF\)](#)
- [Focus Magnif. Time \(still image/movie\)](#)

Focus Magnifier



You can check the focus by enlarging the image before shooting.

Unlike with [ Auto Magnifier in MF], you can magnify the image without needing to perform manual focusing operations.

- 1 MENU → AF_{MF} (Focus) → [Focus Assistant] → [Focus Magnifier].
- 2 Press the center of the control wheel to enlarge the image and select the area you want to enlarge using top/bottom/left/right side of the control wheel.
 - You can set the initial magnification by selecting MENU → AF_{MF} (Focus) → [Focus Assistant] → [ Initial Focus Mag.] or [ Initial Focus Mag.].
- 3 Confirm the focus.
 - Press the  (Delete) button to bring the magnified position into the center of an image.
 - When the focus mode is [Manual Focus], you can adjust the focus while an image is magnified. The [Focus Magnifier] function will be canceled when the shutter button is pressed halfway.
 - You can set how long the image is to be shown magnified by selecting MENU → AF_{MF} (Focus) → [Focus Assistant] → [ Focus Magnif. Time].

To use the focus magnifier function by touch operation

When [Touch Func. in Shooting] is set to [Touch Focus], you can magnify the image and adjust the focus by touching the monitor. Set in advance as follows.

- [Touch Operation]: [On]
 - Set [Shooting Screen] to [On].
 - Set [Touch Func. in Shooting] to [Touch Focus].

When the focus mode is [Manual Focus], you can perform [Focus Magnifier] by double-tapping the area to focus on.

Hint

- While using the focus magnifier function, you can move the magnified area by dragging it on the touch panel.
- To exit the focus magnifier function, double-tap the monitor again. You can also exit the focus magnifier function by pressing the shutter button halfway down.

Related Topic

- [Auto Magnifier in MF \(still image/movie\)](#)
- [Focus Magnif. Time \(still image/movie\)](#)
- [Initial Focus Mag. \(still image\)](#)

- Initial Focus Mag. (movie)
- Touch Operation
- Shooting Screen

5-049-603-11(1) Copyright 2023 Sony Corporation

Digital Camera
ZV-1M2

Focus Magnif. Time (still image/movie)



Set the duration for which an image is to be magnified using the [Auto Magnifier in MF] or [Focus Magnifier] function.

① MENU → AF_{MF} (Focus) → [Focus Assistant] → [Focus Magnif. Time] → desired setting.

Menu item details

2 Sec:

Magnifies the images for 2 seconds.

5 Sec:

Magnifies the images for 5 seconds.

No Limit:

Magnifies the images until you press the shutter button.

Related Topic

- [Auto Magnifier in MF \(still image/movie\)](#)
- [Focus Magnifier](#)

Digital Camera
ZV-1M2

Initial Focus Mag. (movie)



Sets the initial magnification scale for [Focus Magnifier] in the movie shooting mode.

① MENU → AF_{MF} (Focus) → [Focus Assistant] → [▶■ Initial Focus Mag.] → desired setting.

Menu item details

x1.0:

Displays the image with the same magnification as the shooting screen.

x4.0:

Displays a 4.0-times enlarged image.

Related Topic

- [Focus Magnifier](#)

Initial Focus Mag. (still image)



Sets the initial magnification scale when using [Focus Magnifier]. Select a setting that will help you frame your shot.

① MENU → AF_{MF} (Focus) → [Focus Assistant] → [ Initial Focus Mag.] → desired setting.

Menu item details

x1.0:

Displays the image with the same magnification as the shooting screen.

x5.3:

Displays a 5.3-times enlarged image.

Related Topic

- [Focus Magnifier](#)

Digital Camera
ZV-1M2

Peaking Display



Sets the peaking function, which enhances the outline of in-focus areas during shooting with Manual Focus or Direct Manual Focus.

- 1 MENU → AF_{MF} (Focus) → [Peaking Display] → Select a menu item and set the desired parameter.

Menu item details

Peaking Display:

Sets whether to display peaking. ([On] / [Off])

Peaking Level:

Sets the level of enhancement of in-focus areas. ([High] / [Mid] / [Low])

Peaking Color:

Sets the color used to enhance in-focus areas. ([Red] / [Yellow] / [Blue] / [White])

Note

- Since the product recognizes sharp areas as in focus, the effect of peaking differs, depending on the subject.
- The outline of in-focus ranges is not enhanced on devices connected via HDMI.

Related Topic

- [Manual Focus \(Set Focus\)](#)
- [Direct manual focus \(DMF\)](#)

Exposure Comp. (still image/movie)



Normally, exposure is set automatically (auto exposure). Based on the exposure value set by auto exposure, you can make the entire image brighter or darker if you adjust [ Exposure Comp.] to the plus side or minus side, respectively (exposure compensation).



- 1  ( Exposure Comp.) on the control wheel → press the left/right side of the control wheel or turn the control wheel, and select the desired setting.

+ (over) side:

Images become brighter.

- (under) side:

Images become darker.

- You can also select MENU →  (Exposure/Color) → [Exposure Comp.] → [ Exposure Comp.].
- When [Touch Operation] is set to [On] and [Footer Icon Touch] is set to [On], you can change the exposure compensation values using touch operations.
- You can adjust the exposure compensation value within the range of -3.0 EV to +3.0 EV.
- You can confirm the exposure compensation value that you set on the shooting screen.

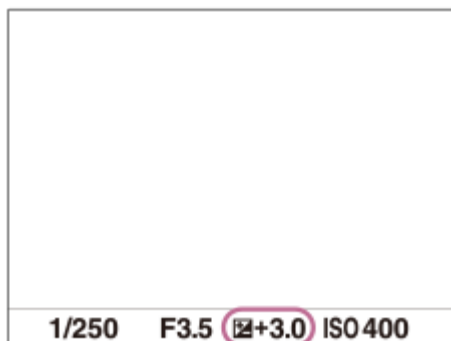

Hint

- You can adjust the exposure compensation value within the range of -2.0 EV to +2.0 EV for movies.

Note

- You cannot perform the exposure compensation in the following shooting modes:
 - [Intelligent Auto]
 - [Scene Selection]
- When using [Manual Exposure], you can perform the exposure compensation only when [ ISO] is set to [ISO AUTO].
- If you shoot a subject in extremely bright or dark conditions, or when you use the flash, you may not be able to get a satisfactory effect.

Related Topic

- [Exp.comp.set](#)
- [Cont. Bracket](#)
- [Single Bracket](#)
- [Zebra Display](#)

5-049-603-11(1) Copyright 2023 Sony Corporation

Histogram display

A histogram shows the luminance distribution, displaying how many pixels there are by luminance. To display the histogram on the shooting screen or playback screen, press the DISP (Display Setting) button repeatedly.

How to read the histogram

The histogram indicates darker values toward the left and brighter values toward the right. The histogram changes depending on the exposure compensation. A peak at the right or left end of the histogram indicates that the image has an overexposed or underexposed area, respectively. You cannot correct such defects using a computer after shooting. Perform exposure compensation before shooting as necessary.



(A): Pixel count
(B): Brightness

Note

- The information in the histogram display does not indicate the final photograph. It is information about image displayed on the screen. The final result depends on the aperture value, etc.
- The histogram display is extremely different between shooting and playback in the following cases:
 - When the flash is used
 - When shooting a low luminance subject such as a night scene

Related Topic

- [DISP \(Display Setting\) button](#)
- [Exposure Comp. \(still image/movie\)](#)

Digital Camera
ZV-1M2

D-Range Optimizer (still image/movie)



By dividing the image into small areas, the product analyzes the contrast of light and shadow between the subject and the background, and creates an image with the optimal brightness and gradation.

1 MENU → (Exposure/Color) → [Color/Tone] → [D-Range Optimizer] → desired setting.

Menu item details

Off:

Does not adjust brightness and gradation.

D-Range Optimizer:

If you select [D-Range Optimizer: Auto], the camera will automatically adjust the brightness and gradation. To optimize the gradation of a recorded image by individual areas, select an optimization level from [D-Range Optimizer: Lv1] (weak) to [D-Range Optimizer: Lv5] (strong).

Note

- In the following situations, [D-Range Optimizer] is fixed to [Off]:
 - When [Picture Profile] is set to other than [Off]
 - When [Rec Frame Rate] is set to [120p]/[100p].
- [D-Range Optimizer] is fixed to [Off] when the following modes are selected in [Scene Selection].
 - [Sunset]
 - [Night Scene]
 - [Night Portrait]

The setting is fixed to [D-Range Optimizer: Auto] when [Scene Selection] modes other than the above modes are selected.

- When shooting with [D-Range Optimizer], the image may be noisy. Select the proper level by checking the recorded image, especially when you enhance the effect.

Metering Mode (still image/movie)



Selects the metering mode that sets which part of the screen to measure for determining the exposure.

① MENU → (Exposure/Color) → [Metering] → [Metering Mode] → desired setting.

Menu item details

Multi:

Measures light on each area after dividing the total area into multiple areas and determines the proper exposure of the entire screen (Multi-pattern metering).

Center:

Measures the average brightness of the entire screen, while emphasizing the central area of the screen (Center-weighted metering).

Spot:

Measures only inside the metering circle. This mode is suitable for measuring light on a specified part of the entire screen. The size of the metering circle can be selected from [Spot: Standard] and [Spot: Large].

Entire Screen Avg.:

Measures the average brightness of the entire screen. The exposure will be stable even if the composition or the position of the subject changes.

Highlight:

Measures the brightness while emphasizing the highlighted area on the screen. This mode is suitable for shooting the subject while avoiding overexposure.

Hint

- When [Multi] is selected and [Face Priority in Multi Metering] is set to [On], the camera measures brightness based on detected faces.
- When [Metering Mode] is set to [Highlight] and the [D-Range Optimizer] function is activated, the brightness and the contrast will be corrected automatically by dividing the image into small areas and analyzing the contrast of light and shadow. Make settings based on the shooting circumstances.

Note

- [Metering Mode] is locked to [Multi] in the following shooting situations:
 - [Scene Selection]
 - When using a zoom function other than the optical zoom
- In [Highlight] mode, the subject may be dark if a brighter part exists on the screen.

Related Topic

- [AE lock](#)
- [Face Priority in Multi Metering \(still image/movie\)](#)
- [D-Range Optimizer \(still image/movie\)](#)

Face Priority in Multi Metering (still image/movie)



Sets whether the camera measures brightness based on detected faces when [Metering Mode] is set to [Multi].

① MENU → (Exposure/Color) → [Metering] → [Face Priority in Multi Metering] → desired setting.

Menu item details

On:

The camera measures brightness based on detected faces.

Off:

The camera measures brightness using the [Multi] setting, without detecting faces.

Note

- When [Subject Recog in AF] under [Subject Recognition] is set to [On] and [Recognition Target] is set to [Animal], [Face Priority in Multi Metering] does not work.

Related Topic

- [Metering Mode \(still image/movie\)](#)

ND Filter (still image/movie)



If you use an ND filter, the amount of light entering the camera is reduced. You can slow down the shutter speed and decrease the aperture value for a better exposure.

1 MENU →  (Exposure/Color) → [Exposure] → [ ND Filter] → desired setting.

Menu item details

Auto:

Automatically turns on the ND filter based on the shooting mode and brightness when shooting still images.

On:

Always uses [ ND Filter].

Off:

Disables the [ ND Filter] function.

Hint

- When the ND filter is activated, the icon is displayed on the bottom of the screen.





Note

- You cannot select [Auto] in movie shooting mode and slow-motion/quick-motion shooting mode.



AE lock





When the contrast between the subject and background is high, such as when shooting a backlit subject or a subject near a window, meter the light at a spot where the subject appears to have the appropriate brightness and lock the exposure before shooting. To reduce the brightness of the subject, meter the light at a spot brighter than the subject and lock the exposure of the entire screen. To make the subject brighter, meter the light at a spot darker than the subject and lock the exposure of the entire screen.

- 1 MENU** →  (Setup) → [Operation Customize] → [ Custom Key Setting] or [ Custom Key Setting] → desired key, then assign [AEL toggle] to the key.
- 2 Adjust the focus on the spot at which the exposure is adjusted.**
- 3 Press the button to which [AEL toggle] is assigned.**
The exposure is locked, and  (AE lock) is displayed.
- 4 Focus on the subject again and press the shutter button.**
 - To cancel the exposure lock, press the button to which the [AEL toggle] function is assigned.

Hint

- If you select the [AEL hold] function in [ Custom Key Setting] or [ Custom Key Setting], you can lock the exposure as long as you are holding down the button. You cannot set the [AEL hold] function to [Left Button] or [Right Button].

Note

- [ AEL hold] and [ AEL toggle] are not available when using zoom functions other than optical zoom.

Related Topic

- [Assigning frequently used functions to buttons \(Custom Key Setting\)](#)

Digital Camera
ZV-1M2

Auto Slow Shutter



Sets whether or not to adjust the shutter speed automatically when recording movies if the subject is dark. This function cannot be used during slow-motion/quick-motion recording.

1 MENU → (Exposure/Color) → [Exposure] → [Auto Slow Shutter] → desired setting.

Menu item details

On:
Uses Auto Slow Shutter. The shutter speed automatically slows when recording in dark locations. You can reduce noise in the movie by using a slow shutter speed when recording in dark locations.

Off:
Does not use Auto Slow Shutter. The recorded movie will be darker than when [On] is selected, but you can record movies with smoother motion and less object blur.

Note

- [Auto Slow Shutter] does not function in the following situations:
 - S (Shutter Priority)
 - M (Manual Exposure)
 - When ISO is set to other than [ISO AUTO]

Digital Camera
ZV-1M2

Zebra Display



Sets a zebra pattern, which appears over part of an image if the brightness level of that part meets the IRE level that you have set. Use this zebra pattern as a guide to adjust the brightness.

1 MENU →  (Exposure/Color) → [Zebra Display] → Select a menu item and set the desired parameter.

Menu item details

Zebra Display:

Sets whether to display the zebra pattern. ([Off] / [On])

Zebra Level:

Adjusts the brightness level of the zebra pattern. ([70] / [75] / [80] / [85] / [90] / [95] / [100] / [100+])

Hint

- You can register values to check the correct exposure or overexposure as well as the brightness level for [ Zebra Level]. The settings for correct exposure confirmation and overexposure confirmation are registered to [Custom 1] and [Custom 2] respectively in the default settings.
- To check the correct exposure, set a standard value and the range for the brightness level. The zebra pattern will appear on areas that fall within the range you set.
- To check the overexposure, set a minimum value for the brightness level. The zebra pattern will appear over areas with a brightness level equal to or higher than the value you set.

Note

- The zebra pattern is not displayed on devices connected via HDMI.

Digital Camera
ZV-1M2

ISO (still image/movie)



Sensitivity to light is expressed by the ISO number (recommended exposure index). The larger the number, the higher the sensitivity.

1 ISO on the control wheel → select desired setting.

- You can also select MENU →  (Exposure/Color) → [Exposure] → [ ISO].

Menu item details

ISO AUTO:

Sets the ISO sensitivity automatically.

ISO 80 – ISO 12800:

Sets the ISO sensitivity manually. Selecting a larger number increases the ISO sensitivity.

Hint

- You can change the range of ISO sensitivity that is set automatically in [ISO AUTO] mode. Select [ISO AUTO] and press the right side of the control wheel, and set the desired values for [ISO AUTO Maximum] and [ISO AUTO Minimum].
- The higher the ISO value, the more noise will appear on the images.
- The available ISO settings will differ depending on whether you are shooting still images, shooting movies, or shooting slow-motion/quick-motion movies.
- When shooting movies, ISO values between 125 and 12800 are available. If the ISO value is set to a value smaller than 125, the setting is automatically switched to 125. When you finish recording the movie, the ISO value returns to the original setting.
- The available range for ISO sensitivity varies depending on the setting for [Gamma] under [ Picture Profile].

Note

- [ ISO] is set to [ISO AUTO] in the following shooting modes:
 - [Intelligent Auto]
 - [Scene Selection]
- When the ISO sensitivity is set to a value lower than ISO 125, the range for recordable subject brightness (dynamic range) may decrease.
- When you select [ISO AUTO] with the shooting mode set to [P], [A], [S] or [M], the ISO sensitivity will be automatically adjusted within the set range.
- If you point the camera at an extremely strong light source while shooting images with a low ISO sensitivity, highlighted areas in the images may be recorded as black areas.

Digital Camera
ZV-1M2

ISO AUTO Min. SS



If you select [ISO AUTO] when the shooting mode is P (Program Auto) or A (Aperture Priority), you can set the shutter speed at which the ISO sensitivity starts changing.

This function is effective for shooting moving subjects. You can minimize subject blurring while also preventing camera shake.

① MENU →  (Exposure/Color) → [Exposure] → [ISO AUTO Min. SS] → desired setting.

Menu item details

SLOWER (Slower)/SLOW (Slow):

The ISO sensitivity will start to change at shutter speeds slower than [Standard], so you can shoot images with less noise.

STD (Standard):

The camera automatically sets the shutter speed based on the focal length of the lens.

FAST (Fast)/FASTER (Faster):

The ISO sensitivity will start to change at shutter speeds faster than [Standard], so you can prevent camera shake and subject blurring.

1/32000 — 1/4"

The ISO sensitivity starts to change at the shutter speed you have set.

Hint

- The difference in shutter speed at which ISO sensitivity starts to change between [Slower], [Slow], [Standard], [Fast], and [Faster] is 1 EV.

Note

- If the exposure is insufficient even when the ISO sensitivity is set to [ISO AUTO Maximum] in [ISO AUTO], in order to shoot with an appropriate exposure, the shutter speed will be slower than the speed set in [ISO AUTO Min. SS].
- In the following situations, the shutter speed may not function as set:
 - When using the flash to shoot bright scenes. (The maximum shutter speed is limited to the flash-syncing speed of 1/100 second.)
 - When using the flash to shoot dark scenes with the [Flash Mode] set to [Fill-flash]. (The minimum shutter speed is limited to the speed automatically determined by the camera.)

Related Topic

- [Shoot Mode: Program Auto](#)
- [Shoot Mode: Aperture Priority](#)
- [ISO \(still image/movie\)](#)

White Balance (still image/movie)



Corrects the tone effect of the ambient light condition to record a neutral white subject in white. Use this function when the color tones of the image did not come out as you expected, or when you want to change the color tones on purpose for photographic expression.

1 MENU → (Exposure/Color) → [White Balance] → [White Balance] → desired setting.

Menu item details

AWB Auto / **Auto: Ambience** / **Auto: White** / **Daylight** / **Shade** / **Cloudy** / **Incandescent** / **-1 Fluor.: Warm White** / **0 Fluor.: Cool White** / **+1 Fluor.: Day White** / **+2 Fluor.: Daylight** / **Flash (only when shooting still images)** / **Underwater Auto** :

When you select a light source that illuminates the subject, the product adjusts the color tones to suit to the selected light source (preset white balance). When you select [Auto], the product automatically detects the light source and adjusts the color tones.

C.Temp./Filter:

Adjusts the color tones depending on the light source. Achieves the effect of CC (Color Compensation) filters for photography.

Custom 1/Custom 2/Custom 3:

Memorizes the basic white color under the light conditions for the shooting environment.

Hint

- You can display the fine adjustment screen and perform fine adjustments of the color tones as required by pressing the right side of the control wheel.
- If the color tones do not come out as you expected in the selected settings, perform [WB bracket] shooting.
- (Auto: Ambience), (Auto: White) is displayed only when [Priority Set in AWB] is set to [Ambience] or [White].

Note

- [White Balance] is fixed to [Auto] in the following shooting modes:
 - [Intelligent Auto]
 - [Scene Selection]
 - When [Cinematic Vlog Set.] is set to [On]
- If you use a mercury lamp or a sodium lamp as a light source, the accurate white balance will not be obtained because of the characteristics of the light. It is recommended to shoot images using a flash or select [Custom 1] to [Custom 3].

Related Topic

- [Capturing a standard white color to set the white balance \(custom white balance\)](#)
- [Priority Set in AWB \(still image/movie\)](#)
- [WB bracket](#)

Capturing a standard white color to set the white balance (custom white balance)



In a scene where the ambient light consists of multiple types of light sources, it is recommended to use the custom white balance in order to accurately reproduce the whiteness. You can register 3 settings.

- 1 MENU** → (Exposure/Color) → [White Balance] → [White Balance] → Select from among [Custom 1] to [Custom 3], and then press the right side of the control wheel.
- 2** Select SET (custom white balance set), and then press the center of the control wheel.
- 3** Hold the product so that the white area fully covers the white-balance capture frame, and then press the center of the control wheel.

After the shutter sound is heard and the message [Captured the custom WB data.] is displayed, the calibrated values (Color Temperature and Color Filter) are displayed.

- You can adjust the position of the white-balance capture frame by pressing the top/bottom/left/right side of the control wheel.
- After capturing a standard white color, you can display the fine adjustment screen by pressing the right side of the control wheel. You can finely adjust the color tones as needed.
- No shutter sound is produced in the following cases.
 - In the movie recording mode
 - When [Silent Mode] is set to [On]

- 4** Press the center of the control wheel.

The calibrated values will be registered. The monitor returns to the MENU display while retaining the memorized custom white balance setting.

- The registered custom white balance setting will remain memorized until overwritten by the another setting.

Note

- The message [Capturing of the custom WB failed.] indicates that the value is in the unexpected range, for example when the subject is too vivid. You can register the setting at this point, but it is recommended that you set the white balance again.
- If you use a flash when capturing a basic white color, the custom white balance will be registered with the lighting from the flash. Be sure to use a flash whenever you shoot with recalled settings that were registered with a flash.

Digital Camera
ZV-1M2

Priority Set in AWB (still image/movie)



Selects which tone to prioritize when shooting under lighting conditions such as incandescent light when [ White Balance] is set to [Auto].

1 MENU →  (Exposure/Color) → [White Balance] → [ Priority Set in AWB] → desired setting.

Menu item details

AWB
STD **Standard:**

Shoots with standard auto white balance. The camera automatically adjusts the color tones.

AWB
Ambi **Ambience:**

Prioritizes the color tone of the light source. This is suitable when you want to produce a warm atmosphere.

AWB
White **White:**

Prioritizes a reproduction of white color when the color temperature of the light source is low.

Related Topic

- [White Balance \(still image/movie\)](#)

Shutter AWB Lock



You can set whether or not to lock the white balance while the shutter button is pressed when [ White Balance] is set to [Auto] or [Underwater Auto].

This function prevents unintentional changes to the white balance during continuous shooting or when shooting with the shutter button pressed halfway down.

1 MENU →  (Exposure/Color) → [White Balance] → [Shutter AWB Lock] → desired setting.

Menu item details

Shutter Half Press:

Locks the white balance while the shutter button is pressed halfway down, even in the auto white balance mode. The white balance is also locked during continuous shooting.

Cont. Shooting:

Locks the white balance to the setting in the first shot during continuous shooting, even in the auto white balance mode.

Off:

Operates with the normal auto white balance.

About [AWB Lock Hold] and [AWB Lock Toggle]

You can also lock the white balance in the auto white balance mode by assigning [AWB Lock Hold] or [AWB Lock Toggle] to the custom key. If you press the assigned key during shooting, the white balance will be locked.

The [AWB Lock Hold] function locks the white balance by stopping the automatic white balance adjustment while the button is pressed.

The [AWB Lock Toggle] function locks the white balance by stopping the automatic white balance adjustment after the button is pressed once. When you press the button again, the AWB lock is released.

- If you want to lock the white balance while recording a movie in the auto white-balance mode, also assign [AWB Lock Hold] or [AWB Lock Toggle] to the custom key.

Hint

- When you shoot with the flash while the automatic white balance is locked, the resulting color tones may be unnatural because the white balance was locked before the flash was emitted. In this case, set [Shutter AWB Lock] to [Off] or [Cont. Shooting], and do not use the [AWB Lock Hold] function or [AWB Lock Toggle] function when shooting. Alternatively, set [ White Balance] to [Flash].

Related Topic

- [White Balance \(still image/movie\)](#)
- [Assigning frequently used functions to buttons \(Custom Key Setting\)](#)

Creative Look (still image/movie)



“Look” is a term referring to the looks and impressions of images generated by various factors, such as color, sharpness, brightness, etc. With [Creative Look], you can choose the finish of an image by selecting a preferred look from among preinstalled looks. In addition, you can fine-tune the contrast, highlights, shadows, fade, saturation, sharpness, and clarity for each “Look.”

- 1 MENU → [Exposure/Color] → [Color/Tone] → [Creative Look].
- 2 Select the desired “Look” using the top/bottom of the control wheel.
- 3 To adjust (Contrast), (Highlights), (Shadows), (Fade), (Saturation), (Sharpness) and (Clarity), move to the right using the right side of the control wheel. Select the desired item using the right/left sides, and then select the value using the top/bottom sides.

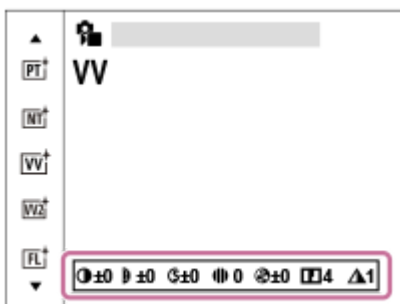

Menu item details

[ST] ST:

Standard finish for a wide range of subjects and scenes.

[PT] PT:

For capturing skin in a soft tone, ideally suited for shooting portraits.

[NT] NT:

The saturation and sharpness are lowered for shooting images in subdued tones. This is also suitable for capturing image material to be modified with a computer.

[VV] VV:

The saturation and contrast are heightened for shooting striking images of colorful scenes and subjects such as flowers, spring greenery, blue sky, or ocean views.

[VV2] VV2:

Creates an image with bright and vivid colors with rich clarity.

[FL] FL:

Creates an image with moody finish by applying sharp contrast to the calm coloring as well as the impressive sky and colors of the greens.

[IN] IN:

Creates an image with matte textures by suppressing the contrast and saturation.

[SH] SH:

Creates an image with bright, transparent, soft, and vivid mood.

 **BW:**

For shooting images in black and white monotone.

 **SE:**

For shooting images in sepia monotone.

To adjust in greater detail

Based on each “Look,” items such as contrast can be adjusted to your liking.

Select an item to be set by pressing the right/left sides of the control wheel, then set the value using the top/bottom sides of the control wheel.

When a setting value is changed from the default value, * (asterisk) is added next to the “Look” icon displayed on the shooting screen.

 **Contrast:**

The higher the value selected, the more the difference of light and shadow is accentuated, and the bigger the effect on the image. (-9 to +9)

 **Highlights:**

Adjusts the brightness of the bright areas. When a higher value is selected, the image becomes brighter. (-9 to +9)

 **Shadows:**

Adjusts the darkness of the dark areas. When a higher value is selected, the image becomes brighter. (-9 to +9)

 **Fade:**

Adjusts the degree of fade. A larger value makes the effect greater. (0 to 9)

 **Saturation:**

The higher the value selected, the more vivid the color. When a lower value is selected, the color of the image is restrained and subdued. (-9 to +9)

 **Sharpness:**

Adjusts the sharpness. The higher the value selected, the more the contours are accentuated, and the lower the value selected, the more the contours are softened. (0 to 9)

 **Clarity:**

Adjusts the degree of clarity. A larger value makes the effect greater. (0 to 9)



To reset adjusted values for each “Look”

Adjusted values such as contrast that you have changed as desired can be collectively reset for each “Look.” Press the  (delete) button on the adjustment screen for the “Look” that you want to reset. All adjusted values that have been changed will return to their default values.

Hint

- For [Sharpness] and [Clarity], take a test shot and either enlarge and play it on the camera monitor, or output it to a playback device to check the effect. Then, readjust the setting if needed.

Note

- [ Creative Look] is fixed to [-] in the following situations:
 - [ Picture Profile] is set to other than [Off].
- When this function is set to [BW] or [SE], [Saturation] cannot be adjusted.

Picture Profile (still image/movie)



Allows you to change the settings for the color, gradation, etc.



For details on “Picture Profile,” refer to

<https://helpguide.sony.net/di/pp/v1/en/index.html>

Although [ Picture Profile] can be used for both still images and movies, the function is designed mainly for movies.

Customizing the picture profile

You can customize the picture quality by adjusting picture profile items such as [Gamma] and [Detail]. When setting these parameters, connect the camera to a TV or monitor, and adjust them while observing the picture on the screen.

- 1 MENU →  (Exposure/Color) → [Color/Tone] → [ Picture Profile] → the profile you want to change.
- 2 Move to the item index screen by pressing the right side of the control wheel.
- 3 Select the item to change using the top/bottom sides of the control wheel.
- 4 Select the desired value using the top/bottom sides of the control wheel and press in the center.

Using the preset of the picture profile

The default settings [PP1] through [PP10] for movies have been set in advance in the camera based on various shooting conditions.

MENU →  (Exposure/Color) → [Color/Tone] → [ Picture Profile] → desired setting.

PP1:

Example setting using [Movie] gamma.

PP2:

Example setting using [Still] gamma.

PP3:

Example setting of natural color tone using the [ITU709] gamma.

PP4:

Example setting of a color tone faithful to the ITU709 standard.

PP5:

Example setting using [Cine1] gamma.

PP6:

Example setting using [Cine2] gamma.

PP7:

Example setting using [S-Log2] gamma.

PP8:

Example setting using the [S-Log3] gamma and the [S-Gamut3.Cine] under [Color Mode].

PP9:

Example setting using the [S-Log3] gamma and the [S-Gamut3] under [Color Mode].

PP10:

Example setting for recording HDR movies using [HLG2] gamma.

HDR movie recording

The camera can record HDR movies when a gamma from [HLG], [HLG1] to [HLG3] is selected in the picture profile. Picture profile preset [PP10] provides an example setting for HDR recording. Movies recorded using [PP10] can be viewed with a wider range of brightness than usual when played back on a TV supporting Hybrid Log-Gamma (HLG). This way, even scenes with a wide range of brightness can be recorded and displayed faithfully, without looking under or over-exposed. HLG is used in HDR TV program production, as defined in the international standard Recommendation ITU-R BT.2100.

Items of the picture profile

Black Level

Sets the black level. (-15 to +15)

Gamma

Selects a gamma curve.

Movie: Standard gamma curve for movies

Still: Standard gamma curve for still images

Cine1: Softens the contrast in dark parts and emphasizes gradation in bright parts to produce a relaxed color movie. (equivalent to HG4609G33)

Cine2: Similar to [Cine1] but optimized for editing with up to 100% video signal. (equivalent to HG4600G30)

ITU709: Gamma curve that corresponds to ITU709.

ITU709(800%): Gamma curve for confirming scenes on the assumption of shooting using [S-Log2] or [S-Log3].

S-Log2: Gamma curve for [S-Log2]. This setting is based on the assumption that the picture will be processed after shooting.

S-Log3: Gamma curve for [S-Log3] with more similar features to film. This setting is based on the assumption that the picture will be processed after shooting.

HLG: Gamma curve for HDR recording. Equivalent to the HDR standard Hybrid Log-Gamma, ITU-R BT.2100.

HLG1: Gamma curve for HDR recording. Emphasizes noise reduction. However, shooting is restricted to a narrower dynamic range than with [HLG2] or [HLG3].

HLG2: Gamma curve for HDR recording. Provides a balance of dynamic range and noise reduction.

HLG3: Gamma curve for HDR recording. Wider dynamic range than [HLG2]. However, noise may increase.

- [HLG1], [HLG2], and [HLG3] all apply a gamma curve with the same characteristics, but each offers a different balance between dynamic range and noise reduction. Each has a different maximum video output level, as follows: [HLG1]: approx. 87%, [HLG2]: approx. 95%, [HLG3]: approx. 100%.

Black Gamma

Corrects gamma in low intensity areas.

[Black Gamma] is fixed at "0" and cannot be adjusted when [Gamma] is set to [HLG], [HLG1], [HLG2], or [HLG3].

Range: Selects the correcting range. (Wide / Middle / Narrow)

Level: Sets the correcting level. (-7 (maximum black compression) to +7 (maximum black stretch))

Knee

Sets knee point and slope for video signal compression to prevent over-exposure by limiting signals in high intensity areas of the subject to the dynamic range of your camera.

When [Gamma] is set to the following, and [Mode] is set to [Auto], [Knee] is unavailable. [Knee] can be used when [Mode] is set to [Manual].

- [Still]
- [Cine1]

- [Cine2]
- [ITU709(800%)]
- [S-Log2]
- [S-Log3]
- [HLG]
- [HLG1]
- [HLG2]
- [HLG3]

Mode: Selects auto/manual settings.

- Auto: The knee point and slope are set automatically.
- Manual: The knee point and slope are set manually.

Auto Set: Settings when [Auto] is selected for [Mode].

- Max Point: Sets the maximum point of the knee point. (90% to 100%)
- Sensitivity: Sets the sensitivity. (High / Mid / Low)

Manual Set: Settings when [Manual] is selected for [Mode].

- Point: Sets the knee point. (75% to 105%)
- Slope: Sets the knee slope. (-5 (gentle) to +5 (steep))

Color Mode

Sets type and level of colors.

In [Color Mode], only [BT.2020] and [709] are available when [Gamma] is set to [HLG], [HLG1], [HLG2], or [HLG3].

Movie: Suitable colors when [Gamma] is set to [Movie].

Still: Suitable colors when [Gamma] is set to [Still].

Cinema: Suitable colors when [Gamma] is set to [Cine1] or [Cine2].

Pro: Similar color tones to the standard image quality of Sony professional cameras (when combined with ITU709 gamma)

ITU709 Matrix: Colors corresponding to ITU709 standard (when combined with ITU709 gamma)

Black & White: Sets the saturation to zero for shooting in black and white.

S-Gamut: Setting based on the assumption that the pictures will be processed after shooting. Used when [Gamma] is set to [S-Log2].

S-Gamut3.Cine: Setting based on the assumption that the pictures will be processed after shooting. Used when [Gamma] is set to [S-Log3]. This setting allows you to shoot in a color space that can easily be converted for digital cinema.

S-Gamut3: Setting based on the assumption that the pictures will be processed after shooting. Used when [Gamma] is set to [S-Log3]. This setting allows you to shoot in a wide color space.

BT.2020: Standard color tone when [Gamma] is set to [HLG], [HLG1], [HLG2], or [HLG3].

709: Color tone when [Gamma] is set to [HLG], [HLG1], [HLG2], or [HLG3] and movies are recorded with HDTV color (BT.709).

Saturation

Sets the color saturation. (-32 to +32)

Color Phase

Sets the color phase. (-7 to +7)

Color Depth

Sets the color depth for each color phase. This function is more effective for chromatic colors and less effective for achromatic colors. The color looks deeper as you increase the setting value towards the positive side, and lighter as you decrease the value towards the negative side. This function is effective even if you set [Color Mode] to [Black & White].

[R] -7 (light red) to +7 (deep red)

[G] -7 (light green) to +7 (deep green)

[B] -7 (light blue) to +7 (deep blue)

[C] -7 (light cyan) to +7 (deep cyan)

[M] -7 (light magenta) to +7 (deep magenta)

[Y] -7 (light yellow) to +7 (deep yellow)

Detail

Sets items for [Detail].



Level: Sets the [Detail] level. (-7 to +7)

Adjust: The following parameters can be selected manually.

- Mode: Selects auto/manual setting. (Auto (automatic optimization) / Manual (The details are set manually.))
- V/H Balance: Sets the vertical (V) and horizontal (H) balance of DETAIL. (-2 (off to the vertical (V) side) to +2 (off to the horizontal (H) side))
- B/W Balance: Selects the balance of the lower DETAIL (B) and the upper DETAIL (W). (Type1 (off to the lower DETAIL (B) side) to Type5 (off to the upper DETAIL (W) side))
- Limit: Sets the limit level of [Detail]. (0 (Low limit level: likely to be limited) to 7 (High limit level: unlikely to be limited))
- Crispening: Sets the crispening level. (0 (shallow crispening level) to 7 (deep crispening level))
- Hi-Light Detail: Sets the [Detail] level in the high intensity areas. (0 to 4)



To copy the settings to another picture profile number

You can copy the settings of the picture profile to another picture profile number.

MENU →  (Exposure/Color) → [Color/Tone] → [ Picture Profile] → desired setting → [Copy].

To reset the picture profile to the default setting

You can reset the picture profile to the default setting. You cannot reset all picture profile settings at once.

MENU →  (Exposure/Color) → [Color/Tone] → [ Picture Profile] → desired setting → [Reset].

Note

- Movie shooting and still image shooting share the same setting values. Adjust the setting values when you switch shooting modes.
- If you develop RAW images with shooting settings, the following settings are not reflected:
 - Black Level
 - Black Gamma
 - Knee
 - Color Depth
- If you change [Gamma], the available ISO value range changes.
- When using the S-Log2 or S-Log3 gamma, noise becomes more noticeable compared to when using other gammas. If the noise is still considerable even after processing the images, it may be improved by shooting with a brighter setting. However, the dynamic range becomes narrower accordingly when you shoot with a brighter setting. We recommend checking the picture in advance by test shooting when using S-Log2 or S-Log3.
- Setting [ITU709(800%)], [S-Log2] or [S-Log3] may cause an error in the white balance custom setup. In this case, perform custom setup with a gamma other than [ITU709(800%)], [S-Log2], or [S-Log3] first, and then reselect [ITU709(800%)], [S-Log2], or [S-Log3] gamma.
- When set to [ITU709(800%)], [S-Log2], or [S-Log3], the settings for [Black Level] become disabled.
- If you set [Slope] to +5 in [Manual Set] under [Knee], [Knee] will be disabled.
- S-Gamut, S-Gamut3.Cine, and S-Gamut3 are color spaces exclusive to Sony. However, this camera's S-Gamut setting does not support the whole S-Gamut color space; it is a setting to achieve a color reproduction equivalent to S-Gamut.

Related Topic

- [Gamma Display Assist](#)

Soft Skin Effect (still image/movie)



Sets the effect used for shooting the skin smoothly when a face is recognized.

① MENU → (Exposure/Color) → [Color/Tone] → [Soft Skin Effect] → desired setting.

Menu item details

Off:

Does not use the [Soft Skin Effect] function.

On:

Uses the [Soft Skin Effect]. You can set the effect level by pressing the right/left side of the control wheel. ([On: High]/[On: Mid]/[On: Low])

Note

- [Soft Skin Effect] is not available when [File Format] is set to [RAW].
- [Soft Skin Effect] is not available for RAW images when [File Format] is set to [RAW & JPEG].
- [Soft Skin Effect] is not available when using the digital zoom function.
- [Soft Skin Effect] is unavailable in the movie recording mode under the following conditions.
 - [File Format] is set to [XAVC S 4K], and [Proxy Recording] under [Proxy Settings] is set to [On].
 - [File Format] is set to [XAVC S 4K], [Rec Frame Rate] under [Movie Settings] is set to [30p], and [Rec. Media dur HDMI Output] under [HDMI Output Settings] is set to [On].
 - [File Format] is set to [XAVC S 4K] and connecting to the camera from a computer, etc.
 - [File Format] is set to [XAVC S 4K] while shooting remotely from a smartphone.
 - [File Format] is set to [XAVC S HD], and [Rec Frame Rate] under [Movie Settings] is set to [120p]/[100p].
- [Soft Skin Effect] is not applied on the monitor while shooting in the movie recording mode when [File Format] is set to [XAVC S 4K], but the effect will be applied to the recorded images.

Digital Camera
ZV-1M2

Drive Mode



Select the appropriate mode for the subject, such as single shooting, continuous shooting or bracketing shooting.

- 1 Select (Drive Mode) on the control wheel → desired setting.
 - You can also set the drive mode by selecting MENU → (Shooting) → [Drive Mode] → [Drive Mode].
- 2 Select the desired mode using the right/left side of the control wheel.

Menu item details

Single Shooting:

Normal shooting mode.

Cont. Shooting:

Shoots images continuously while you press and hold down the shutter button.

Self-timer(Single) :

Shoots an image using the self-timer after a designated number of seconds have elapsed since the shutter button was pressed.

Self-timer(Cont):

Shoots a designated number of images using the self-timer after a designated number of seconds have elapsed since the shutter button was pressed.

BRK C Cont. Bracket:

Shoots images while holding the shutter button down, each with different degrees of exposure.

BRK S Single Bracket:

Shoots a specified number of images, one by one, each with a different degrees of exposure.

BRK WB WB bracket:

Shoots a total of three images, each with different color tones according to the selected settings for white balance, color temperature and color filter.

BRK DRO DRO Bracket:

Shoots a total of three images, each at a different degree of D-Range Optimizer.

Note

- When the shooting mode is set to [Scene Selection] and [Sports Action] is selected, [Single Shooting] cannot be performed.

Related Topic

- [Cont. Shooting](#)
- [Self-timer\(Single\)](#)
- [Self-timer\(Cont\)](#)
- [Cont. Bracket](#)
- [Single Bracket](#)
- [WB bracket](#)

Cont. Shooting



Shoots images continuously while you press and hold down the shutter button.

- 1 Select / (Drive Mode) of the control wheel → [Cont. Shooting].
 - You can also set the continuous shooting by selecting MENU → (Shooting) → [Drive Mode] → [Drive Mode].
- 2 Select the desired mode using the right/left side of the control wheel.

Menu item details



Continuous Shooting: Hi:

Continuous shooting speed is set at a maximum of about 24 images per second.*



Continuous Shooting: Mid:

Continuous shooting speed is set at a maximum of about 10 images per second.*



Continuous Shooting: Lo:

Continuous shooting speed is set at a maximum of about 3 images per second.

* When the F-value is greater than F8, the focus is locked to the setting in the first shot.

Hint

- To continuously adjust the focus and exposure during continuous shooting, set as follows:
– [Focus Mode]: [Continuous AF]

Related Topic

- [Selecting the focus method \(Focus Mode\)](#)

Self-timer(Single)



Shoots an image using the self-timer after a designated number of seconds have elapsed since the shutter button was pressed. Use the 5-second/10-second self-timer when you are going to be in the picture, and use the 2-second self-timer to reduce camera-shake caused by pressing the shutter button.

- 1 Press / (Drive Mode) of the control wheel → [Self-timer(Single)].
 - You can also set the drive mode by selecting MENU → (Shooting) → [Drive Mode] → [Drive Mode].
- 2 Select the desired mode using the right/left side of the control wheel.
- 3 Adjust the focus and shoot the image.

The self-timer lamp flashes, a beep sounds, and a picture is taken after the designated number of seconds have elapsed.

Menu item details

The mode determines the number of seconds until a picture is taken after the shutter button is pressed.

Self-timer(Single): 10 sec

Self-timer(Single): 5 sec

Self-timer(Single): 2 sec

Hint

- Press the shutter button again or press / (Drive Mode) on the control wheel to stop the count of the self-timer.
- Press / (Drive Mode) on the control wheel and select (Single Shooting) to cancel the self-timer.
- Set [Audio signals] to [Off] to turn off the beeping sound during the self-timer countdown.
- To use the self-timer in bracket mode, select bracket mode under drive mode, then select MENU → (Shooting) → [Drive Mode] → [Bracket Settings] → [Selftimer during Bracket].

Note

- The self-timer is unavailable in the following situations:
 - [Sports Action] under [Scene Selection]

Related Topic

- [Audio signals](#)

Self-timer(Cont)



Shoots a designated number of images using the self-timer after a designated number of seconds have elapsed since the shutter button was pressed. You can choose the best from multiple shots.

- 1 Press / (Drive Mode) of the control wheel → [Self-timer(Cont)].
 - You can also set the drive mode by selecting MENU → (Shooting) → [Drive Mode] → [Drive Mode].

- 2 Select the desired mode using the right/left side of the control wheel.

- 3 Adjust the focus and shoot the image.

The self-timer lamp flashes, a beep sounds, and pictures are taken after the designated number of seconds has elapsed. The designated number of pictures are taken continuously.

Menu item details

For example, three images are shot when 10 seconds have elapsed after the shutter button is pressed when [Self-timer(Cont.): 10 Sec. 3 Img.] is selected.

³/_{10s} Self-timer(Cont.): 10 Sec. 3 Img.

⁵/_{10s} Self-timer(Cont.): 10 Sec. 5 Img.

³/_{5s} Self-timer(Cont.): 5 Sec. 3 Img.

⁵/_{5s} Self-timer(Cont.): 5 Sec. 5 Img.

³/_{2s} Self-timer(Cont.): 2 Sec. 3 Img.

⁵/_{2s} Self-timer(Cont.): 2 Sec. 5 Img.



Hint

- Press the shutter button again or press / (Drive Mode) on the control wheel to stop the count of the self-timer.
- Press / (Drive Mode) on the control wheel and select (Single Shooting) to cancel the self-timer.

Cont. Bracket



Shoots multiple images while automatically shifting the exposure from base to darker and then to lighter. You can select an image that suits your purpose after recording.

- 1 Press  /  (Drive Mode) of the control wheel → [Cont. Bracket].**
 - You can also set the drive mode by selecting MENU →  (Shooting) → [Drive Mode] → [Drive Mode].
- 2 Select the desired mode using the right/left side of the control wheel.**
- 3 Adjust the focus and shoot the image.**
 - Keep pressing and holding the shutter button until bracket shooting is finished.

Menu item details

For example, the camera shoots a total of three images continuously with an exposure value shifted by plus or minus 0.3 EV when [Cont. Bracket: 0.3EV 3 Image] is selected.

Hint

- The last shot is shown on the auto review.

Note

- When [ISO AUTO] is selected in [Manual Exposure] mode, the exposure is changed by adjusting the ISO value. If a setting other than [ISO AUTO] is selected, the exposure is changed by adjusting the shutter speed.
- When the exposure is compensated, the exposure is shifted based on the compensated value.
- Bracket shooting is unavailable in the following shooting modes:
 - [Intelligent Auto]
 - [Scene Selection]
 - When [ Picture Profile] is set to other than [Off]
- When the flash is used, the product performs flash bracket shooting, which shifts the amount of flash light even if [Cont. Bracket] is selected. Press the shutter button for each image.

Related Topic



- [Bracket Settings](#)
- [Indicator during bracket shooting](#)

Single Bracket



Shoots multiple images while automatically shifting the exposure from base to darker and then to lighter. You can select the image that suits your purpose after recording.

Since a single picture is taken each time you press the shutter button, you can adjust the focus or the composition for each shot.

- 1 Select  /  (Drive Mode) of the control wheel → [Single Bracket].**
 - You can also set the drive mode by selecting MENU →  (Shooting) → [Drive Mode] → [Drive Mode].
- 2 Select the desired mode using the right/left side of the control wheel.**
- 3 Adjust the focus and shoot the image.**
 - Press the shutter button for each image.

Menu item details

For example, when [Single Bracket: 0.3EV 3 Image] is selected, three images are shot one at a time with the exposure value shifted up and down in increments of 0.3 EV.

Note

- When [ISO AUTO] is selected in [Manual Exposure] mode, the exposure is changed by adjusting the ISO value. If a setting other than [ISO AUTO] is selected, the exposure is changed by adjusting the shutter speed.
- When the exposure is compensated, the exposure is shifted based on the compensated value.
- Bracket shooting is unavailable in the following shooting modes:
 - [Intelligent Auto]
 - [Scene Selection]
 - When [ Picture Profile] is set to other than [Off]

Related Topic

- [Bracket Settings](#)
- [Indicator during bracket shooting](#)

Digital Camera
ZV-1M2

Indicator during bracket shooting

On the [Display All Info.] or [Histogram] screen, you can use the bracket indicator to confirm the bracket shooting settings.

Ambient light* bracketing

3 images shifted by 0.3 EV steps

Exposure compensation ± 0.0 EV



Flash bracketing

3 images shifted by 0.7 EV steps

Flash compensation -1.0 EV

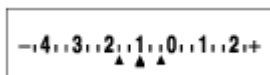

* Ambient light: A generic term for non-flash light including natural light, electric bulb and fluorescent lighting. Whereas the flash light blinks for a moment, ambient light is constant, so this kind of light is called "ambient light."

Hint

- During bracket shooting, guides equal to the number of images to be shot are displayed over/under the bracket indicator.
- When you start single bracket shooting, the guides will disappear one by one as the camera records images.

WB bracket



Shoots a total of three images, each with different color tones according to the selected settings for white balance, color temperature and color filter.

- 1 Select / (Drive Mode) of the control wheel → [WB bracket].
 - You can also set the drive mode by selecting MENU → (Shooting) → [Drive Mode] → [Drive Mode].
- 2 Select the desired mode using the right/left side of the control wheel.
- 3 Adjust the focus and shoot the image.

Menu item details

White Balance Bracket: Lo:

Records a series of three images with small changes in the white balance (within the range of 10MK^{-1*}).

White Balance Bracket: Hi:

Records a series of three images with large changes in the white balance (within the range of 20MK^{-1*}).

* MK^{-1} is the unit that indicates the capability of color temperature conversion filters and indicates the same value as "mired."

Hint

- The last shot is shown on the auto review.

Related Topic

- [Bracket Settings](#)

DRO Bracket



You can record a total of three images, each at a different degree of D-Range Optimizer value.

- 1** Select / (Drive Mode) of the control wheel → [DRO Bracket].
 - You can also set the drive mode by selecting MENU → (Shooting) → [Drive Mode] → [Drive Mode].
- 2** Select the desired mode using the right/left side of the control wheel.
- 3** Adjust the focus and shoot the image.

Menu item details

DRO Bracket: Lo:

Records a series of three images with small changes in the D-Range Optimizer value (Lv 1, Lv 2, and Lv 3).

DRO Bracket: Hi:

Records a series of three images with large changes in the D-Range Optimizer value (Lv 1, Lv 3, and Lv 5).

Hint

- The last shot is shown on the auto review.

Related Topic

- [Bracket Settings](#)

Bracket Settings



You can set the self-timer in bracket shooting mode, and the shooting order for exposure bracketing and white balance bracketing.

1 MENU → (Shooting) → [Drive Mode] → [Bracket Settings] → desired setting.

Menu item details

Selftimer during Bracket:

Sets whether to use the self-timer during bracket shooting. Also sets the number of seconds until the shutter is released if using the self-timer.

(Off/2 Sec/5 Sec/10 Sec)

Bracket order:

Sets the order of exposure bracketing and white balance bracketing.

(0→→+/-→0→+)

Related Topic

- [Cont. Bracket](#)
- [Single Bracket](#)
- [WB bracket](#)
- [DRO Bracket](#)



Self-timer (movie)



You can start shooting with the self-timer when recording a movie.

1 Press  /  (Drive Mode) of the control wheel.

The [ Self-timer] setting screen will be displayed.

- You can also set the drive mode by selecting MENU →  (Shooting) → [Shooting Option] → [ Self-timer].

2 Select [On] using the control wheel and set the desired countdown time.

- Rec Start delay: Sets the count time until the start of movie recording. (3 s/5 s/10 s)
- Repetition: Sets whether to repeat the movie self-timer. (Repeat/Only Once)
If you select [Repeat], the movie self-timer will be activated repeatedly even after movie recording is completed.
If you select [Only Once], the movie self-timer will be canceled after movie recording is completed, and the camera will return to the normal movie recording standby mode.

3 Adjust the focus and press the MOVIE (movie) button.

When the countdown appears on the recording standby screen, the self-timer lamp flashes, a beep sounds, and recording starts after the designated number of seconds has elapsed.

- Press the MOVIE button again to end recording.

Menu item details

On:

Uses the movie self-timer function.

Off:

Does not use the movie self-timer function.

Hint

- To stop the self-timer countdown, press the MOVIE button again or press the button to which the [ Self-timer] function is assigned.

Note

- If you press the MOVIE button in the still image shooting mode to start movie recording, [ Self-timer] will not work.

Interval Shoot Func.



You can automatically shoot a series of still images with the shooting interval and number of shots that you set in advance (Interval shooting). You can then create a time-lapse movie from the still images produced by interval shooting using the computer software Imaging Edge Desktop (Viewer). You cannot create a movie from the still images on the camera.

For details on time-lapse movies, refer to the support page for Imaging Edge Desktop.

<https://www.sony.net/disoft/help/>

- 1 MENU** → (Shooting) → [Drive Mode] → [Interval Shoot Func.] → [Interval Shooting] → [On].
- 2 MENU** → (Shooting) → [Drive Mode] → [Interval Shoot Func.] → Select an item to set, and then select the desired setting.
- 3 Press the shutter button.**

When the time set for [Shooting Start Time] has elapsed, shooting will start.

 - When the number of shots set for [Number of Shots] is completed, the camera will return to the standby screen for interval shooting.

Menu item details

Interval Shooting:

Sets whether to perform interval shooting. ([Off]/[On])

Shooting Start Time:

Sets the time from when you press the shutter button to when interval shooting starts. (1 second to 99 minutes 59 seconds)

Shooting Interval:

Sets the shooting interval (time from when one exposure starts to when the exposure for the next shot starts). (1 second to 60 seconds)

Number of Shots:

Sets the number of shots for interval shooting. (1 shot to 9 999 shots)

AE Tracking Sensitivity:

Sets the tracking sensitivity of the auto exposure against the change in luminance during interval shooting. If you select [Low], exposure changes during interval shooting will be smoother. ([High]/[Mid]/[Low])

Hint

- If you press the shutter button during interval shooting, interval shooting will end and the camera will return to the standby screen for interval shooting.
- To return to the normal shooting mode, set [Interval Shooting] to [Off].
- If you press a key to which one of the following functions has been assigned at the moment when shooting starts, the function will remain active during interval shooting even without you holding down the button.

- [AEL hold]
- [ AEL hold]
- [AF/MF Selector Hold]
- [AWB Lock Hold]

- If you set [Display as Group] to [On], still images shot with the interval shooting function will be displayed in groups.
- Still images shot with interval shooting can be played back continuously on the camera. If you intend to create a movie using the still images, you can preview the result.

Note

- You may not be able to record the set number of images depending on the remaining battery level and the amount of free space on the recording medium. Supply power via USB while shooting, and use a memory card with sufficient space.
- When the shooting interval is short, the camera may get hot easily. Depending on the ambient temperature, you may not be able to record the set number of images because the camera may stop recording to protect the equipment.
- During interval shooting (including the time between pressing the shutter button and the start of shooting), you cannot operate the dedicated shooting setting screen or MENU screen. Some settings such as shutter speed can be set by operating the part of the control wheel to which the function is assigned.
- During interval shooting, auto review is not displayed.

Related Topic

- [Cont. Play for Interval](#)
- [Supplying power from a wall outlet \(wall socket\)](#)

Digital Camera
ZV-1M2

File Format (still image)



Sets the file format for still images.

1 MENU → (Shooting) → [Image Quality/Rec] → [File Format] → desired setting.

Menu item details

RAW:

Digital processing is not performed on this file format. Select this format to process images on a computer for professional purposes.

RAW & JPEG:

A RAW image and a JPEG image are created at the same time. This is suitable when you need two image files, a JPEG for viewing, and a RAW for editing.

JPEG:

The image is recorded in the JPEG format.

About RAW images

- To open a RAW image file recorded with this camera, the software Imaging Edge Desktop is needed. With Imaging Edge Desktop, you can open a RAW image file, then convert it into a popular image format such as JPEG or TIFF, or readjust the white balance, saturation or contrast of the image.
- RAW images shot by the camera are recorded in the compressed RAW format.

Note

- If you do not intend to edit the images on your computer, we recommend that you record in JPEG format.

Related Topic

- [JPEG Quality](#)
- [JPEG Image Size](#)
- [Introduction to computer software \(Imaging Edge Desktop/Catalyst\)](#)

Digital Camera
ZV-1M2

JPEG Quality



Selects the image quality when recording JPEG images.

① MENU →  (Shooting) → [Image Quality/Rec] → [JPEG Quality] → desired setting.

Menu item details

Extra fine/Fine/Standard:

Since the compression rate increases from [Extra fine] to [Fine] to [Standard], the file size decreases in the same order. This allows more files to be recorded on one memory card, but the image quality is lower.

Related Topic

- [File Format \(still image\)](#)

Digital Camera
ZV-1M2

JPEG Image Size



The larger the image size, the more detail will be reproduced when the image is printed on large-format paper. The smaller the image size, the more images can be recorded.

1 MENU → (Shooting) → [Image Quality/Rec] → [JPEG Image Size] → desired setting.

Menu item details

When [Aspect Ratio] is set to 3:2

Setting values	Pixel number (horizontal×vertical)
L: 20M	5472×3648 pixels
M: 10M	3888×2592 pixels
S: 5.0M	2736×1824 pixels

When [Aspect Ratio] is set to 4:3

Setting values	Pixel number (horizontal×vertical)
L: 18M	4864×3648 pixels
M: 10M	3648×2736 pixels
S: 5.0M	2592×1944 pixels

When [Aspect Ratio] is set to 16:9

Setting values	Pixel number (horizontal×vertical)
L: 17M	5472×3080 pixels
M: 7.5M	3648×2056 pixels
S: 4.2M	2720×1528 pixels

When [Aspect Ratio] is set to 1:1

Setting values	Pixel number (horizontal×vertical)
L: 13M	3648×3648 pixels
M: 6.5M	2544×2544 pixels
S: 3.7M	1920×1920 pixels

Note

- The image size for RAW images corresponds to “L.”

Related Topic

- [File Format \(still image\)](#)
- [Aspect Ratio](#)

5-049-603-11(1) Copyright 2023 Sony Corporation

Digital Camera
ZV-1M2

Aspect Ratio



① MENU →  (Shooting) → [Image Quality/Rec] → [Aspect Ratio] → desired setting.

Menu item details

3:2:

Same aspect ratio as 35 mm film

4:3:

The aspect ratio is 4:3.

16:9:

The aspect ratio is 16:9.

1:1:

The aspect ratio is 1:1.

Digital Camera
ZV-1M2

Color Space



The way colors are represented using combinations of numbers or the range of color reproduction is called “color space.” You can change the color space depending on the purpose of the image.

1 MENU → (Shooting) → [Image Quality/Rec] → [Color Space] → desired setting.

Menu item details

sRGB:

This is the standard color space of the digital camera. Use [sRGB] in normal shooting, such as when you intend to print out the images without any modification.

AdobeRGB:

This color space has a wide range of color reproduction. When a large part of the subject is vivid green or red, Adobe RGB is effective. The file name of the recorded image starts with “_.”

Note

- [AdobeRGB] is for applications or printers that support color management and DCF2.0 option color space. Images may not be printed or viewed in the correct colors if you use applications or printers that do not support Adobe RGB.
- When displaying images that were recorded with [AdobeRGB] on non-Adobe RGB-compliant devices, the images will be displayed with low saturation.

File Format (movie)



Selects the movie file format.

① MENU → / (Shooting) → [Image Quality/Rec] → [File Format] → desired setting.

Menu item details

File Format	Characteristics
XAVC S 4K	Records movies in 4K resolution (3840×2160).
XAVC S HD	Records movies in HD resolution (1920×1080).

Related Topic

- [Memory cards that can be used](#)

Movie Settings (movie)



Sets the frame rate, bit rate, color information, etc.

1 MENU → / (Shooting) → [Image Quality/Rec] → [Movie Settings] → [Rec Frame Rate] → desired setting.

2 MENU → / (Shooting) → [Image Quality/Rec] → [Movie Settings] → [Record Setting] → desired setting.

Example of setting values

100M **4:2:0** **8bit**
100M 4:2:0 8bit
 (A) (B) (C)

(A): Bit rate

(B): Color sampling

(C): Bit depth

- The higher the bit rate, the higher the image quality.

Menu item details

When [File Format] is set to [XAVC S 4K]

Rec Frame Rate	Record Setting	Size	Movie compression format
30p/25p	100M 4:2:0 8bit	3840×2160	Long GOP
30p/25p	60M 4:2:0 8bit	3840×2160	Long GOP
24p*	100M 4:2:0 8bit	3840×2160	Long GOP
24p*	60M 4:2:0 8bit	3840×2160	Long GOP

* Only when [NTSC/PAL Selector] is set to NTSC.

When [File Format] is set to [XAVC S HD]

Rec Frame Rate	Record Setting	Size	Movie compression format
60p/50p	50M 4:2:0 8bit	1920×1080	Long GOP
60p/50p	25M 4:2:0 8bit	1920×1080	Long GOP

Rec Frame Rate	Record Setting	Size	Movie compression format
30p/25p	50M 4:2:0 8bit	1920×1080	Long GOP
30p/25p	16M 4:2:0 8bit	1920×1080	Long GOP
24p*	50M 4:2:0 8bit	1920×1080	Long GOP
120p/100p	100M 4:2:0 8bit	1920×1080	Long GOP
120p/100p	60M 4:2:0 8bit	1920×1080	Long GOP

* Only when [NTSC/PAL Selector] is set to NTSC.

Note

- Recording frame rates are indicated as the closest integer values. The actual corresponding frame rates are as follows: 24p: 23.98 fps, 30p: 29.97 fps, 60p: 59.94 fps, and 120p: 119.88 fps.

Related Topic

- [File Format \(movie\)](#)

5-049-603-11(1) Copyright 2023 Sony Corporation

S&Q Settings



You can record a moment that cannot be captured by the naked eye (slow-motion recording), or record a long-term phenomenon into a compressed movie (quick-motion recording). For example, you can record an intense sports scene, the moment when a bird starts to fly, a blooming flower, and a changing view of clouds or a starry sky. Sound will not be recorded.

- 1 Press the **Still/Movie/S&Q** button to select the slow-motion/quick-motion recording mode.
- 2 **MENU** → (Shooting) → [Shooting Mode] → [**S&Q** Shoot Mode] → and select the desired setting of slow-motion/quick-motion (Intelligent Auto, Program Auto, Aperture Priority, Shutter Priority, or Manual Exposure).
- 3 Select **MENU** → (Shooting) → [Image Quality/Rec] → [**S&Q** S&Q Settings] → Select an item to set, and then select the desired setting.
- 4 Press the **MOVIE** (movie) button to start recording.
 - Press the **MOVIE** button again to stop recording.

Menu item details

S&Q Rec Frame Rate:

Selects the frame rate of the movie.

S&Q Frame Rate:

Selects the frame rate for movie shooting.

- The format of the recorded movie will be locked to [XAVC S HD] regardless of the [File Format] setting.

Playback speed

The playback speed will vary as below depending on the [**S&Q** Rec Frame Rate] and [**S&Q** Frame Rate] settings.

When [NTSC/PAL Selector] is set to NTSC

S&Q Frame Rate	S&Q Rec Frame Rate: 24p	S&Q Rec Frame Rate: 30p	S&Q Rec Frame Rate: 60p
120fps	5 times slower	4 times slower	—
60fps	2.5 times slower	2 times slower	Normal playback speed
30fps	1.25 times slower	Normal playback speed	2 times quick
15fps	1.6 times quick	2 times quick	4 times quick

S&Q Frame Rate	S&Q Rec Frame Rate: 24p	S&Q Rec Frame Rate: 30p	S&Q Rec Frame Rate: 60p
8fps	3 times quick	3.75 times quick	7.5 times quick
4fps	6 times quick	7.5 times quick	15 times quick
2fps	12 times quick	15 times quick	30 times quick
1fps	24 times quick	30 times quick	60 times quick

When [NTSC/PAL Selector] is set to PAL

S&Q Frame Rate	S&Q Rec Frame Rate: 25p	S&Q Rec Frame Rate: 50p
100fps	4 times slower	—
50fps	2 times slower	Normal playback speed
25fps	Normal playback speed	2 times quick
12fps	2.08 times quick	4.16 times quick
6fps	4.16 times quick	8.33 times quick
3fps	8.33 times quick	16.66 times quick
2fps	12.5 times quick	25 times quick
1fps	25 times quick	50 times quick

- When the frame rate is set to [120fps]/[100fps], you cannot set the recording frame rate to [60p]/[50p].

Hint

- For an estimation of recordable time, refer to “[Recordable movie times](#).”
- The bit rate of recorded movies differs depending on the settings for [S&Q Frame Rate] and [S&Q Rec Frame Rate].

Note

- In slow-motion/quick-motion recording, the actual shooting time differs from the time recorded in the movie. The recordable time displayed toward the top of the monitor shows the remaining recording time for the movie, not the remaining recording time on the memory card.
- In slow-motion recording, the shutter speed becomes faster and you may not be able to obtain the proper exposure. If this happens, decrease the aperture value or set the ISO sensitivity to a higher value.
- During slow-motion/quick-motion recording, the following functions are not available.
 - [Time Code Run] under [TC/UB]
 - [Time Code Output] under [▶ HDMI Output Settings]

Related Topic

- [Recordable movie times](#)
- [Memory cards that can be used](#)

Proxy Settings



You can simultaneously record a low-bit-rate proxy movie when recording a movie or slow-motion recording/quick-motion recording.

Since proxy movies are small in file size, they are suitable for transferring to smartphones or uploading to websites.

- 1 **MENU** → (Shooting) → **[Image Quality/Rec]** → **[Px Proxy Settings]** → Select an item to set, and then select the desired setting.

Menu item details

Px Proxy Recording:

Selects whether to simultaneously record proxy movies. ([On] / [Off])

Recording settings for proxy movies

Proxy movies are recorded with the following settings.

File format:

XAVC S HD

Recording size:

1280×720

Recording frame rate:

Max. 60p/Max. 50p

Recording settings:

9Mbps

Compression codec:

MPEG-4 AVC/H.264

Hint

- Proxy movies are not displayed on the playback screen (single-image playback screen or image index screen). **Px** (proxy) is displayed over movies for which a proxy movie was simultaneously recorded.

Note

- Proxy movies cannot be played back on this camera.
- Proxy recording is not available in the following situations.
 - Normal movie recording
 - [Rec Frame Rate] is set to [120p]/[100p]
 - Slow-motion recording/quick-motion recording
 - The frame rate is set to [120fps]/[100fps]

- Deleting/protecting movies that have proxy movies removes/protects both the original and proxy movies. You cannot delete/protect only original movies or proxy movies.
- Movies cannot be edited on this camera.

Related Topic

- [Memory cards that can be used](#)

5-049-603-11(1) Copyright 2023 Sony Corporation

Touch Operation



Sets whether or not to activate touch operations on the monitor.

① **MENU** →  (**Setup**) → **[Touch Operation]** → **[Touch Operation]** → **desired setting**.

Menu item details

On:

Activates touch operations.

Off:

Deactivates touch operations.

Related Topic

- [Touch panel](#)
- [Shooting Screen](#)
- [Playback Screen](#)
- [Menu Screen](#)

Shooting Screen



Configures touch operations on the shooting screen.

① MENU →  (Setup) → [Touch Operation] → [Shooting Screen] → desired setting item.

Menu item details

Shooting Screen:

Sets whether to enable touch operations on the shooting screen. ([On]/[Off])

Footer Icon Touch:

Sets whether to enable touch operations for the footer icons at the bottom of the shooting standby screen. ([On]/[Off])

Swipe Right:

Sets the operation when swiping right on the shooting standby screen. ([Icon Display: Left]/[Icon Display: L&R]/[Off])

Swipe Left:

Sets the operation when swiping left on the shooting standby screen. ([Icon Display: Right]/[Icon Display: L&R]/[Off])

Swipe Up:

Sets the operation when swiping up on the shooting standby screen. ([Open the Fn Menu]/[Off])

Touch Func. in Shooting:

Sets the operation activated by touching the screen during shooting.

[Touch Focus]: Specifies the position to focus.

[Touch Tracking]: Selects a subject to start tracking.

[Touch Shutter]: Focuses on the touched subject and shoots images (only during still image shooting).

[Touch AE]: Specifies the position to adjust the brightness.

[Off]: Disables touch operations.

Icon When Monitor Flipped:

Sets whether to flip the positions of the touch function icons on the left and right in accordance with the monitor when the monitor is flipped. ([Flip]/[Do Not Flip])

Hint

- You can select whether to simultaneously perform [Touch AE] by pressing the left/right sides of the control wheel when [Touch Func. in Shooting] is set to [Touch Focus]/[Touch Tracking]/[Touch Shutter]. When you perform [Touch AE], you can fine-tune the brightness by sliding the brightness adjustment bar that appears after touching.

Note

- You cannot fine-tune the brightness using the brightness adjustment bar when [Touch Func. in Shooting] is set to [Touch Shutter+AE].

Related Topic

- [Touch panel](#)
- [Touch Operation](#)
- [Focusing using touch operations \(Touch Focus\)](#)

- Starting tracking with touch operations (Touch Tracking)
- Shooting with touch operations (Touch Shutter)
- Fn (function) button

5-049-603-11(1) Copyright 2023 Sony Corporation

Playback Screen



Configures touch operations on the playback screen.

① **MENU** →  (**Setup**) → **[Touch Operation]** → **[Playback Screen]** → **desired setting**.

Menu item details

On:

Enables touch operations on the playback screen.

Off:

Disables touch operations on the playback screen.

Related Topic

- [Touch panel](#)
- [Enlarging an image being played back \(Enlarge Image\)](#)

Digital Camera
ZV-1M2

Menu Screen



Configures touch operations on the menu screen.

① MENU →  (Setup) → [Touch Operation] → [Menu Screen] → desired setting.

Menu item details

On:

Enables touch operations on the menu screen.

Off:

Disables touch operations on the menu screen.

Related Topic



- [MENU button](#)
- [Main menu \(shooting setting list\)](#)

Digital Camera
ZV-1M2

Focusing using touch operations (Touch Focus)

[Touch Focus] allows you to specify a position where you want to focus using touch operations. Configure the settings as follows from MENU →  (Setup) → [Touch Operation] in advance:

- [Touch Operation]: [On]
- [Shooting Screen] → [Shooting Screen]: [On]

This function is available when [ Focus Area] is set to one of following parameters. However, the function may not be available depending on the setting for [ Focus Area Limit].

- [Wide]
- [Zone]
- [Center Fix]
- [Tracking: Wide]
- [Tracking: Zone]
- [Tracking: Center Fix]

1 MENU →  (Setup) → [Touch Operation] → [Shooting Screen] → [Touch Func. in Shooting] → [Touch Focus].



Specifying the position where you want to focus in the still image mode

When performing auto-focusing, you can specify the position where you want to focus using touch operations. After touching the monitor and specifying a position, press the shutter button halfway down to focus.

1. Touch the monitor.
 - Touch the subject to focus.
 - To cancel focusing with touch operations, touch  (Touch focus release) icon or press the center of the control wheel.
2. Press the shutter button halfway down to focus.
 - Press the shutter button all the way down to shoot images.

Specifying the position where you want to focus in the movie recording mode (Spot focus)

The camera will focus on the touched subject.

1. Touch the subject on which you want to focus before or during recording.
 - When [ Focus Mode] is set to [Continuous AF], the focus mode temporarily switches to manual focus (spot focus).
 - To cancel spot focus, touch  (Touch focus release) icon or press the center of the control wheel.
 - When [ Focus Mode] is set to [Manual Focus], the focus mode temporarily switches to [Continuous AF]. When the touched area is in focus, the focus mode returns to manual focus.

Hint

- If you set [Touch Func. in Shooting] to [Touch Focus+AE], the brightness will be set according to the subject you touched. This will also allow you to fine-tune the brightness by sliding the brightness adjustment bar that appears after touching.
- In addition to the touch focus function, touch operations such as the following are also available.
 - The focusing frame for [Spot] and [Expand Spot] can be moved by dragging.

- When [ Focus Mode] is set to [Manual Focus], the focus magnifier can be used by double-tapping the monitor.

Note

- The touch focus function is not available in the following situations:
 - When shooting still images in the manual focusing mode
 - When using the digital zoom in the still image shooting mode

Related Topic

- [Touch Operation](#)
- [Shooting Screen](#)
- [Selecting the focus area \(Focus Area\)](#)
- [Focus Area Limit \(still image/movie\)](#)

5-049-603-11(1) Copyright 2023 Sony Corporation

Digital Camera
ZV-1M2

Starting tracking with touch operations (Touch Tracking)

You can use touch operations to select a subject you want to track in the still image shooting mode and movie recording mode.

Configure the settings as follows from MENU →  (Setup) → [Touch Operation] in advance:

- [Touch Operation]: [On]
- [Shooting Screen] → [Shooting Screen]: [On]

1 MENU →  (Setup) → [Touch Operation] → [Shooting Screen] → [Touch Func. in Shooting] → [Touch Tracking].





2 Touch the subject that you want to track on the monitor.

Tracking will start.

Hint

- To cancel tracking, touch  (Tracking release) icon or press the center of the control wheel.
- If you set [Touch Func. in Shooting] to [TouchTracking+AE], the brightness will be set according to the subject you touched. This will also allow you to fine-tune the brightness by sliding the brightness adjustment bar that appears after touching.

Note

- [Touch Tracking] is unavailable in the following situations:
 - When shooting movies with [Rec Frame Rate] under  Movie Settings] set to [120p]/[100p]
 - When  File Format] is set to [XAVC S 4K] and  Proxy Recording] is set to [On]
 - When  File Format] is set to [XAVC S 4K] and outputting a movie via HDMI
 - When  Focus Mode] is set to [Manual Focus].
 - When using Smart Zoom, Clear Image Zoom, or Digital Zoom
- If the focus mode is switched to [Manual Focus] while [Touch Func. in Shooting] is set to [Touch Tracking], the setting value for [Touch Func. in Shooting] will be changed to [Touch Focus].

Related Topic

- [Touch Operation](#)
- [Shooting Screen](#)

Shooting with touch operations (Touch Shutter)

The camera automatically focuses on the point you touch and shoots a still image.

Configure the settings as follows from MENU →  (Setup) → [Touch Operation] in advance:

- [Touch Operation]: [On]
- [Shooting Screen] → [Shooting Screen]: [On]



- 1** MENU →  (Setup) → [Touch Operation] → [Shooting Screen] → [Touch Func. in Shooting] → [Touch Shutter].
- 2** Touch the subject on which you would like to focus.

The camera focuses on the subject you touched, and a still image is recorded.

Hint

- If you set [Touch Func. in Shooting] to [Touch Shutter+AE], the brightness will be set according to the subject you touched.
- You can operate the shooting functions below by touching the monitor:
 - Shooting burst images using the touch shutter
When [Drive Mode] is set to [Cont. Shooting], you can record burst images while touching the monitor.
 - Shooting continuous bracket images using the touch shutter
The product shoots three images while automatically shifting the exposure from base, to darker, and then to lighter. When [Drive Mode] is set to [Cont. Bracket], keep touching the monitor until the shooting ends. After the recording you can select the image you prefer.

Note

- The [Touch Shutter] function is unavailable in the following situations:
 - When shooting movies
 - When shooting slow-motion/quick-motion movies
 - When [ Focus Mode] is set to [Manual Focus]
 - When [ Focus Area] is set to [Spot] / [Expand Spot] / [Tracking: Spot S] / [Tracking: Spot M] / [Tracking: Spot L] / [Tracking: Expand Spot]
 - While using the digital zoom function
 - While using the Clear Image Zoom
- When using Clear Image Zoom or Digital Zoom while [Touch Func. in Shooting] is set to [Touch Shutter], the setting value temporarily changes from [Touch Shutter] to [Off].
- If the focus mode is switched to [Manual Focus] while [Touch Func. in Shooting] is set to [Touch Shutter], the setting value for [Touch Func. in Shooting] will change to [Touch Focus].

Related Topic

- [Touch Operation](#)
- [Shooting Screen](#)

Adjusting the exposure with touch operations (Touch AE)

You can automatically set the exposure based on the brightness of a point you touch.

Configure the settings as follows from MENU →  (Setup) → [Touch Operation] in advance:

- [Touch Operation]: [On]
- [Shooting Screen] → [Shooting Screen]: [On]

1 MENU →  (Setup) → [Touch Operation] → [Shooting Screen] → [Touch Func. in Shooting] → select [Touch AE].

2 Touch the point that you want to set as the basis for the exposure.

The camera will set the exposure based on the brightness of the point you touched.

- You can fine-tune the brightness with sliding the brightness adjustment bar that appears after touching.

Hint

- The adjustment using the brightness adjustment bar is reflected in the exposure compensation value.
- When [Touch Func. in Shooting] is set to [Touch Focus]/[Touch Tracking]/[Touch Shutter], you can select whether or not to perform [Touch AE] at the same time by pressing the left or right side of the control wheel.

Note

- [Touch AE] is not available in the following situations:
 - When using digital zoom function
- If the subject is extremely bright or dark, the adjustment bar may not be sufficiently effective.

Related Topic

- [Touch Operation](#)
- [Shooting Screen](#)

Silent Mode (still image/movie)



Sets whether or not to shoot without shutter sounds or electronic sounds.

① MENU →  /  (Shooting) → [Shutter/Silent] → [ Silent Mode] → desired setting.

Menu item details

On:

Does not produce a shutter sound or electronic sounds.

Off:

Produces a shutter sound and electronic sounds.

Note

- Use the silent mode function on your own responsibility, while taking sufficient consideration to the privacy and portrait rights of the subject.
- Even if [ Silent Mode] is set to [On], the aperture, focus, etc. will make operating sounds.

Release w/o Card



Sets whether the shutter can be released when no memory card has been inserted.

① MENU →  (Shooting) → [Shutter/Silent] → [Release w/o Card] → **desired setting.**

Menu item details

Enable:

Releases the shutter even if no memory card has been inserted.

Disable:

Does not release the shutter when no memory card has been inserted.

Note





- When no memory card has been inserted, the images shot will not be saved.
- The default setting is [Enable]. It is recommended that you select [Disable] prior to actual shooting.

Digital Camera
ZV-1M2

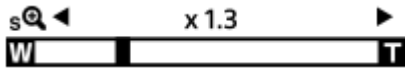
The zoom features available with this product

The zoom feature of the product provides a higher magnification zoom by combining various zoom features. The icon displayed on the screen changes, according to the selected zoom feature.







- **Optical zoom:**
Zoom images in the zoom range of a lens.
- **Smart Zoom ():**
Zoom images without causing the original quality to deteriorate by partially cropping an image (only when [JPEG Image Size] is set to [M] or [S]).
- **Clear Image Zoom ():**
Zoom images using an image process with less deterioration. When you set [ Zoom Range] to [Clear Image Zoom] or [Digital Zoom], you can use this zoom function.
- **Digital Zoom ():**
You can magnify images using an image process. When you set [ Zoom Range] to [Digital Zoom], you can use this zoom function.

Hint

- The default setting for the [JPEG Image Size] is [L]. To use the smart zoom, change [JPEG Image Size] to [M] or [S].

Note

- The Smart Zoom, Clear Image Zoom and Digital Zoom functions are not available when shooting in the following situations:
 - [ File Format] is set to [RAW] or [RAW & JPEG].
 - [Rec Frame Rate] is set to [120p]/[100p].
 - During slow-motion/quick-motion shooting with the frame rate set to [120fps]/[100fps]
- You cannot use the Smart Zoom function with movies.
- When you use a zoom function other than the optical zoom in the still image shooting mode, the [ Focus Area] setting is disabled and the AF operates with priority on and around the center area.
- When you use the Smart Zoom, Clear Image Zoom or Digital Zoom function, [ Metering Mode] is locked to [Multi].
- When using the Smart Zoom, Clear Image Zoom or Digital Zoom function, the following functions are not available:
 - Subject Recognition AF
 -  Face Priority in Multi Metering
 - Tracking function

Related Topic

- [Zoom](#)
- [Zoom Range \(still image/movie\)](#)
- [About zoom scale](#)

Zoom

You can zoom by using the W/T (zoom) lever or by touching the zoom icon on the screen.

Using the zoom lever

1. Enlarge the subject using the W/T (zoom) lever.
 - Move the W/T (zoom) lever to the T side to zoom in and to the W side to zoom out.

Touching the zoom icons on the screen

1. MENU →  (Setup) → [Touch Operation] → [Shooting Screen] → [On].
2. Swipe in from the left or right edge of the screen to display the touch function icons.
 - The swiping direction changes according to the settings for [Swipe Right] and [Swipe Left] under [Shooting Screen].
3. Touch **ZOOM** (Zoom) icon **(A)**, and then select the magnification scale **(B)**. Alternatively, touch and hold the W or T icon **(C)**.

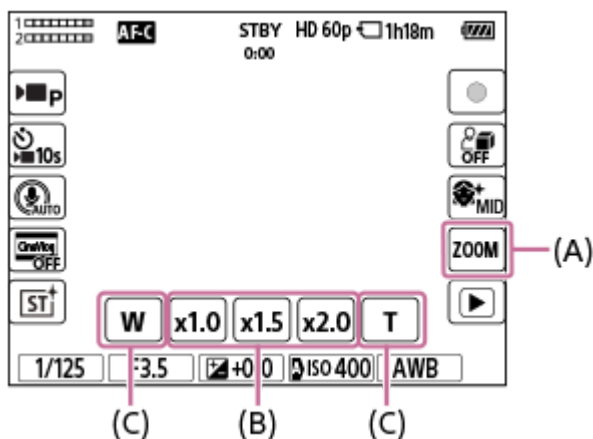

- (A): **ZOOM** (Zoom) icon
(B): Magnification scale
(C): W/T icon

Related Topic

- [Zoom Range \(still image/movie\)](#)
- [Zoom Speed](#)
- [Step Zoom Magnif. \(still image/movie\)](#)

Digital Camera
ZV-1M2

Zoom Range (still image/movie)



You can select the zoom setting of the product.

① MENU → / (Shooting) → [Zoom] → [Zoom Range] → desired setting.

Menu item details

Optical zoom only:

Limits the zoom range to the optical zoom. You can use the Smart Zoom function if you set [JPEG Image Size] to [M] or [S].

Clear Image Zoom :

Select this setting to use Clear Image Zoom. The product magnifies images using an image process with less deterioration.

Digital Zoom :

The product magnifies images to the largest scale. However, the image quality will deteriorate.

Note

- Set [Optical zoom only] if you want to magnify images within the range in which image quality does not deteriorate.

Related Topic

- [The zoom features available with this product](#)
- [About zoom scale](#)

Zoom Speed



Sets the zoom speed. This setting is applied to zoom operations using the zoom lever and when you touch and hold the W/T icons on the screen.

1 MENU →  /  (Shooting) → [Zoom] → [Zoom Speed] → desired setting.

Menu item details

Normal:

Sets the zoom speed to normal.

Fast:

Sets the zoom speed to fast.

Note

- The [Zoom Speed] settings are also used when you are zooming with a remote controller (sold separately) connected to the camera.

Related Topic

- [Zoom](#)

Step Zoom Magnif. (still image/movie)



Set the zoom magnification that can be selected with the touch button on the shooting screen or with the key to which the [Step Zoom] function is assigned.

- 1 **Select MENU** → / (Shooting) → [Zoom] → [Step Zoom Magnif.].
- 2 **Add checkmarks to the magnification values that you want to use and select [OK].**
 - The magnifications with ✓ (check mark) can be selected in the following cases:
 - When you touch the ZOOM (Zoom) button on the shooting screen
 - When you press the custom key to which [Step Zoom] is assigned

Menu item details

Add check marks to the magnification values that you want to use.

x1.0/x1.5/x2.0/x4.0

Hint

- To select the zoom magnification with the custom key, assign [Step Zoom] to the key of your choice with [Custom Key Setting] or [Custom Key Setting] in advance.

Note

- When recording movies, the maximum magnification for the step zoom function may vary depending on the setting for [File Format] or [Zoom Range].
 - when [File Format] is set to HD:
 - Clear Image Zoom: up to [x2.0]
 - Digital Zoom: up to [x4.0]
 - when [File Format] is set to 4K:
 - Clear Image Zoom: up to [x1.5]
 - Digital Zoom: up to [x4.0]

Related Topic

- [Zoom](#)
- [Zoom Range \(still image/movie\)](#)
- [Assigning frequently used functions to buttons \(Custom Key Setting\)](#)

About zoom scale

The zoom scale that is used in combination with the zoom of the lens changes according to the selected image size.

When [Aspect Ratio] is [3:2]

JPEG Image Size	Optical zoom only (smart zoom)	Clear Image Zoom	Digital Zoom
L: 20M	-	Approx. 2×	Approx. 4×
M: 10M	Approx. 1.4×	Approx. 2.8×	Approx. 5.6×
S: 5.0M	Approx. 2×	Approx. 4×	Approx. 8×

Related Topic

- [The zoom features available with this product](#)
- [Zoom Range \(still image/movie\)](#)

Using flash (sold separately)

In dark environments, use the flash to light up the subject while shooting. Also use the flash to prevent camera-shake.

For details on the flash, refer to the instruction manual for the flash.

1 Attach the flash (sold separately) to the product.

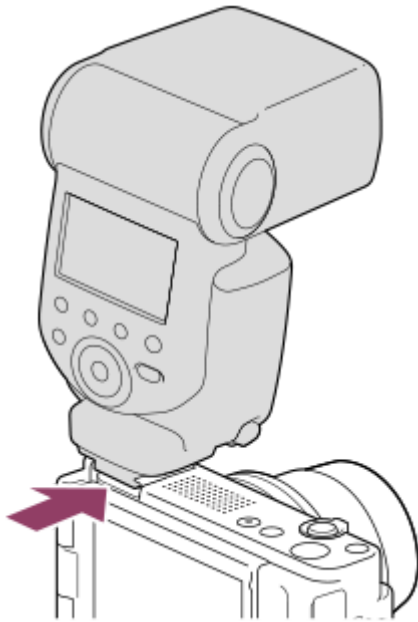

2 Shoot after you have turned on the flash and it is fully charged.

- ⚡ (Charging flash icon) blinking: Charging is in progress
- ⚡ (Charging flash icon) lit up: Charging is finished
- The available flash modes depend on the shooting mode and function.

Note

- You cannot use the flash when recording movies. (You can use an LED light when using a flash (sold separately) with an LED light.)
- Before attaching/removing an accessory such as a flash to/from the Multi Interface Shoe, turn off the product first. When attaching an accessory, make sure that the accessory is fixed securely to the product.
- Do not use the Multi Interface Shoe with a commercially available flash that applies voltage of 250 V or more or has the reverse polarity of the camera. Doing so may cause a malfunction.
- When shooting with the flash and the zoom is set to W, the shadow of the lens may appear on the screen, depending on the shooting conditions. If this happens, shoot away from the subject or set the zoom to T and shoot with the flash again.
- High-speed sync (HSS) photography is not available on this camera.
- For details on compatible accessories for the Multi Interface Shoe, visit the Sony website, or consult your Sony dealer or local authorized Sony service facility.

Related Topic

- [Flash Mode](#)

5-049-603-11(1) Copyright 2023 Sony Corporation

Digital Camera
ZV-1M2

Flash Mode



You can set the flash mode.

① MENU →  (Exposure/Color) → [Flash] → [Flash Mode] → desired setting.

Menu item details

Flash Off:

The flash does not operate.

Autoflash:

The flash works in dark environments or when shooting towards bright light.

Fill-flash:

The flash works every time you trigger the shutter.

Slow Sync.:

The flash works every time you trigger the shutter. Slow sync shooting allows you to shoot a clear image of both the subject and the background by slowing the shutter speed.

Rear Sync.:

The flash works right before the exposure is completed every time you trigger the shutter. Rear sync shooting allows you to shoot a natural image of the trail of a moving subject such as a moving car or a walking person.

Note

- The default setting depends on the shooting mode.
- Some [Flash Mode] settings are not available, depending on the shooting mode.

Related Topic

- [Using flash \(sold separately\)](#)

Digital Camera
ZV-1M2

Flash Comp.



Adjusts the amount of flash light in a range of -3.0 EV to $+3.0$ EV. Flash compensation changes the amount of flash light only. Exposure compensation changes the amount of flash light along with the change of the shutter speed and aperture.

1 MENU →  (Exposure/Color) → [Flash] → [Flash Comp.] → desired setting.

- Selecting higher values (+ side) makes the flash level higher, and lower values (- side) makes the flash level lower.

Note

- [Flash Comp.] does not work when the shooting mode is set to the following modes:
 - [Intelligent Auto]
 - [Scene Selection]
- The higher flash effect (+ side) may not be visible due to the limited amount of flash light available, if the subject is outside the maximum range of the flash. If the subject is very close, the lower flash effect (- side) may not be visible.

Related Topic

- [Using flash \(sold separately\)](#)

Exp.comp.set



Sets whether to apply the exposure compensation value to control both flash light and ambient light, or just ambient light.

① MENU →  (Exposure/Color) → [Flash] → [Exp.comp.set] → desired setting.

Menu item details

Ambient&flash:

Applies the exposure compensation value to control both flash light and ambient light.

Ambient only:

Applies the exposure compensation value to control ambient light only.

Related Topic

- [Flash Comp.](#)

SteadyShot (movie)



Sets [▶■ SteadyShot] effect when shooting movies.

① MENU → ▶■ (Shooting) → [Image Stabilization] → [▶■ SteadyShot] → desired setting.

Menu item details

On (Active):

Provides a more powerful SteadyShot effect.

Off:

Does not use [▶■ SteadyShot].

Note

- When using a tripod, etc., make sure to turn off the SteadyShot function because this can cause any malfunction when shooting.
- If you change the setting for [▶■ SteadyShot], the angle of view will change.
- In the following situations, [▶■ SteadyShot] is fixed to [Off]:
 - Normal movie recording: [Rec Frame Rate] is set to [120p]/[100p]
 - Slow-motion recording/quick-motion recording: [S&Q Frame Rate] is set to [120fps]/[100fps]

Digital Camera
ZV-1M2

High ISO NR



When shooting with high ISO sensitivity, the product reduces noise that becomes more noticeable when the product sensitivity is high.

1 MENU →  (Shooting) → [Image Quality/Rec] → [High ISO NR] → desired setting.

Menu item details

Normal:

Activates high ISO noise reduction normally.



Low:

Activates high ISO noise reduction moderately.

Off:

Does not activate high ISO noise reduction.

Note

- When [ File Format] is set to [RAW], this function is not available.
- [High ISO NR] does not work for RAW images when [ File Format] is [RAW & JPEG].

Auto Review (still image)



You can check the recorded image on the screen right after the shooting. You can also set the display time for Auto Review.

1 MENU →  (Setup) → [Display Option] → [ Auto Review] → desired setting.

Menu item details

10 Sec/5 Sec/2 Sec:

Displays the recorded image on the screen right after shooting for the selected duration of time. If you perform a magnifying operation during Auto Review, you can check that image using the magnified scale.

Off:

Does not display the Auto Review.

Note

- When you use a function that performs image processing, the image before processing may be displayed temporarily, followed by the image after processing.
- The DISP (Display Setting) settings are applied for the Auto Review display.

Related Topic

- [Enlarging an image being played back \(Enlarge Image\)](#)

Digital Camera
ZV-1M2

Grid Line Display (still image/movie)



Sets whether the grid line is displayed or not during shooting. The grid line will help you to adjust the composition of images.

1 MENU → / (Shooting) → [Shooting Display] → [Grid Line Display] → desired setting.

Menu item details

On:

Displays the grid line.

Off:

Does not display the grid line.

Hint

- If you assign [Grid Line Display Select] to a desired key using [Custom Key Setting] or [Custom Key Setting], you can show or hide the grid lines by pressing the assigned key.

Related Topic

- [Grid Line Type \(still image/movie\)](#)
- [Assigning frequently used functions to buttons \(Custom Key Setting\)](#)

Digital Camera
ZV-1M2

Grid Line Type (still image/movie)



Sets the displayed type of grid line. The grid line will help you to adjust the composition of images.

① MENU → / (Shooting) → [Shooting Display] → [Grid Line Type] → desired setting.

Menu item details

Rule of 3rds Grid:

Place main subjects close to one of the grid lines that divide the image into thirds for a well-balanced composition.

Square Grid:

Square grids make it easier to confirm the horizontal level of your composition. This is useful for assessing the composition when shooting landscapes, closeups, or when performing camera scanning.

Diag. + Square Grid:

Place a subject on the diagonal line to express an uplifting and powerful feeling.

Hint

- If you assign [Grid Line Type] to a desired key using [Custom Key Setting] or [Custom Key Setting], you can switch the type of grid line each time you press the assigned key.

Related Topic

- [Grid Line Display \(still image/movie\)](#)
- [Assigning frequently used functions to buttons \(Custom Key Setting\)](#)

Digital Camera
ZV-1M2

Live View Display



Sets whether or not to show images altered with effects of the exposure compensation, white balance, or [Creative Look] on the screen.

1 MENU → / (Shooting) → [Shooting Display] → [Live View Display] → desired setting.

Menu item details

Setting Effect ON:

Displays Live View in conditions close to what your picture will look like as a result of applying all your settings. This setting is useful when you want to shoot pictures while checking the results of the shot on the Live View screen.

Setting Effect OFF:

Displays Live View without the effects of exposure compensation, white balance, or [Creative Look]. When this setting is used, you can easily check the image composition.

Live View is always displayed with the appropriate brightness even in [Manual Exposure] mode.

When [Setting Effect OFF] is selected, the **VIEW** (VIEW) icon is displayed on the Live View screen.



Note

- If you shoot movies in the still image shooting mode, the shooting settings will be reflected in Live View even when [Live View Display] is set to [Setting Effect OFF].
- When [Live View Display] is set to [Setting Effect OFF], the brightness of the shot image will not be the same as that of the displayed Live View.

Bright Monitoring



Allows you to adjust the composition when shooting in dark environments. By extending the exposure time, you can check the composition on the monitor even in dark locations such as under the night sky.

- 1 **MENU** →  (**Setup**) → **[Operation Customize]** → **[ Custom Key Setting]** → assign the **[Bright Monitoring]** function to the desired key.
- 2 **In a still image shooting mode, press the key to which you assigned the [Bright Monitoring] function, and then shoot an image.**
 - The brightness due to [Bright Monitoring] will continue after shooting.
 - To return the monitor brightness to normal, press the key to which you assigned the [Bright Monitoring] function once again.

Note

- During [Bright Monitoring], [Live View Display] will automatically switch to [Setting Effect OFF], and setting values such as exposure compensation will not be reflected in the live view display. It is recommended that you use [Bright Monitoring] only in dark locations.
- [Bright Monitoring] will be automatically canceled in the following situations.
 - When the camera is turned off.
 - When the focus mode is set to other than manual focus.
 - When [ Auto Magnifier in MF] is executed.
 - When [Focus Magnifier] is selected.
- During [Bright Monitoring], the shutter speed may be slower than normal while shooting in dark locations. Also, because the measured brightness range is expanded, the exposure may change.

Related Topic

- [Assigning frequently used functions to buttons \(Custom Key Setting\)](#)
- [Live View Display](#)

Emphasized REC Display



Sets whether or not to display a red frame around the edges of the camera's monitor while recording a movie. You can easily check whether the camera is in standby or recording, even when you are looking at the camera monitor from an angle or at a distance.

1 MENU →  (Shooting) → [Shooting Display] → [Emphasized REC Display] → desired setting.

Menu item details

On:

Displays a red frame to indicate that recording is in progress.

Off:

Does not display a frame to indicate that recording is in progress.

Hint

- The frame displayed by this function can also be output to an external monitor connected via HDMI. Set [HDMI Info. Display] to [On].

Related Topic

- [HDMI Info. Display](#)

Digital Camera
ZV-1M2

Marker Display



While shooting movies, you can set whether or not to display markers on the monitor, and select the types of marker.

1 MENU →  (Shooting) → [Marker Display] → Select a menu item and set the desired parameter.

Menu item details

Marker Display:

Sets whether or not to display markers. ([On] / [Off])

Center Marker:

Sets whether or not to display the center marker in the middle of the shooting screen. ([Off] / [On])

Aspect Marker:

Sets the aspect marker display. ([Off] / [9:16] / [4:5] / [1:1] / [4:3] / [13:9] / [14:9] / [15:9] / [17:9] / [1.66:1] / [1.85:1] / [1.91:1] / [2:1] / [2.35:1] / [2.39:1])

Safety Zone:

Sets the safety zone display. This becomes the standard range that can be received by a general household TV. ([Off] / [80%] / [90%])

Guideframe:

Sets whether or not to display the guide frame. You can verify whether the subject is level or perpendicular to the ground. ([Off] / [On])

Hint

- You can display several markers at the same time.
- Position the subject at the cross point of [Guideframe] to ensure a balanced composition.

Note

- The markers are displayed when the shooting mode is set to [Movie] or [S&Q Motion], or when shooting movies.
- You cannot display markers when using [Focus Magnifier].
- The markers are displayed on the monitor. (You cannot output the markers.)

Digital Camera
ZV-1M2

Gamma Display Assist



Movies with S-Log gamma are assumed to be processed after shooting in order to make use of the wide dynamic range. Images with the HLG gamma are assumed to be displayed on HDR-compatible monitors. They are therefore displayed in low contrast during shooting, and may be difficult to monitor. However, you can use the [Gamma Display Assist] function to reproduce contrast equivalent to that of normal gamma. In addition, [Gamma Display Assist] can also be applied when playing back movies on the camera's monitor.

① MENU →  (Setup) → [Display Option] → [Gamma Display Assist] → desired setting.

Menu item details



On:

Uses the gamma display assist function.

Off:

Does not use the gamma display assist function.

Hint

- If you assign [Gamma Disp. Assist Sel.] to a desired key using [ Custom Key Setting], [ Custom Key Setting], or [ Custom Key Setting], you can turn the gamma display assist function on or off by pressing the assigned key.

Note

- [Gamma Display Assist] is not applied to movies when displayed on a TV or monitor connected to the camera.

Related Topic

- [Picture Profile \(still image/movie\)](#)
- [Gamma Disp. Assist Typ.](#)

Digital Camera
ZV-1M2

Gamma Disp. Assist Typ.



Selects the conversion type for [Gamma Display Assist].

① MENU → (Setup) → [Display Option] → [Gamma Disp. Assist Typ.] → desired setting.

Menu item details

Assist
AUTO **Auto:**

- Displays images with effects as follows according to the gamma or color mode set in [Picture Profile].
 - When the gamma is set to [S-Log2]: [S-Log2→709(800%)]
 - When the gamma is set to [S-Log3]: [S-Log3→709(800%)]
 - When the gamma is set to [HLG], [HLG1], [HLG2], or [HLG3], and the color mode is set to [BT.2020]: [HLG(BT.2020)]
 - When the gamma is set to [HLG], [HLG1], [HLG2], or [HLG3], and the color mode is set to [709]: [HLG(709)]

Assist
S-Log2 **S-Log2→709(800%):**

Displays images with an S-Log2 gamma reproducing contrast equivalent to ITU709 (800%).

Assist
S-Log3 **S-Log3→709(800%):**

Displays images with an S-Log3 gamma reproducing contrast equivalent to ITU709 (800%).

Assist
HLG 2020 **HLG(BT.2020):**

Displays images after adjusting the image quality of the monitor to a quality that is almost the same as when images are displayed on an [HLG(BT.2020)] compatible monitor.

Assist
HLG 709 **HLG(709):**

Displays images after adjusting the image quality of the monitor to a quality that is almost the same as when images are displayed on an [HLG(709)] compatible monitor.

Hint

- If you assign [Gamma Disp. Assist Typ.] to a desired key using [Custom Key Setting] or [Custom Key Setting], you can switch the [Gamma Disp. Assist Typ.] setting.

Note

- When [Gamma Display Assist] is set to [Auto] during playback, an effect is applied to the image as follows:
 - When playing back a movie recorded with [HLG], [HLG1], [HLG2], or [HLG3]: Displays the image with an [HLG(BT.2020)] or [HLG(709)] effect depending on the color mode.

In other situations, movies are displayed according to the gamma setting and color mode setting in [Picture Profile].

Related Topic

- [Gamma Display Assist](#)
- [Picture Profile \(still image/movie\)](#)
- [HDMI Output Settings \(movie\)](#)

Audio Recording



Sets whether to record sounds when shooting movies. Select [Off] to avoid recording the sounds of the lens and the camera operating. This function cannot be used during slow-motion/quick-motion recording.

1 MENU →  (Shooting) → [Audio Recording] → [Audio Recording] → desired setting.

Menu item details

On:

Records sound.

Off:

Does not record sound.

Related Topic

- [Audio Rec Level](#)

Digital Camera
ZV-1M2

Audio Rec Level



You can adjust the audio recording level while checking the level meter. This function cannot be used during slow-motion/quick-motion recording.

- 1 MENU →  (Shooting) → [Audio Recording] → [Audio Rec Level].
- 2 Select the desired level using the right/left sides of the control wheel.

Menu item details

+:
Turns up the audio recording level.

-:
Turns down the audio recording level.

Hint

- When you record audio movies with loud volumes, set [Audio Rec Level] to a lower sound level. Doing so enables you to record more realistic audio. When you record audio movies with lower volumes, set [Audio Rec Level] to a greater sound level to make the sound easier to hear. Check that the volume is at the appropriate level by the volume level meter on the camera.
- To reset the audio recording level to the default setting, press the  (Delete) button.

Note

- Regardless of the [Audio Rec Level] settings, the limiter always operates.
- [Audio Rec Level] is available only when the shooting mode is set to movie mode.
- The [Audio Rec Level] settings are applied for both the internal microphone and the  (microphone) terminal input.

Wind Noise Reduct.



Sets whether or not to reduce wind noise by cutting the low-range sound of the input audio from the built-in microphone. This function cannot be used during slow-motion/quick-motion recording. Although wind noise is reduced by using the wind screen (supplied), use this function along with the wind screen if wind noise is still noticeable.

① **MENU** →  **(Shooting)** → **[Audio Recording]** → **[Wind Noise Reduct.]** → **desired setting.**

Menu item details

On:

Reduces wind noise.

Off:

Does not reduce wind noise.

Note

- The sound quality may vary from the normal recording settings when [Wind Noise Reduct.] is set to [On].
- When an external microphone (sold separately) is used, [Wind Noise Reduct.] does not function.

Digital Camera
ZV-1M2

Microphone Directivity



Sets the direction of sound pickup when using the built-in microphone. This function cannot be used during slow-motion/quick-motion recording.

1 MENU → (Shooting) → [Audio Recording] → [Microphone Directivity] → desired setting.

Menu item details

Auto:

Automatically switches the direction of sound pickup (front or all directions) according to the recognized subject and tracking status.

Front:

Picks up sound in front of the camera.

All Directions:

Picks up sound from all directions around the camera.

Rear:

Picks up sound behind the camera.

Note

- [Microphone Directivity] is disabled when an external microphone is connected.
- When [Microphone Directivity] is set to [Auto] and the digital zoom is used during shooting, the direction of sound pickup remains the same as it was before using the zoom.
- When [Microphone Directivity] is set to [Auto], the camera picks up sound from all directions under the following conditions.
 - [File Format] is set to [XAVC S 4K], [Proxy Recording] under [Proxy Settings] is set to [On], and [Rec. Media dur HDMI Output] is set to [On].
 - [File Format] is set to [XAVC S 4K], [Rec Frame Rate] under [Movie Settings] is set to [30p], and [Rec. Media dur HDMI Output] is set to [On] during an HDMI connection.
 - [File Format] is set to [XAVC S 4K] and connecting to the camera from a computer, etc.
 - [File Format] is set to [XAVC S 4K], and you are performing remote shooting via a smartphone.
 - [Rec Frame Rate] under [Movie Settings] is set to [120p].

Mic Direct Select Setting



Configures the setting values to be selected when changing the directivity of the built-in microphone using the key to which [Mic Directivity Select] is assigned in [ Custom Key Setting].

1 MENU →  (Shooting) → [Audio Recording] → [Mic Direct Select Setting].

2 Add a  (check) mark to the value that you want to enable.

The setting values marked with  (check) will be available when performing [Mic Directivity Select] with the custom key.

Related Topic

- [Assigning frequently used functions to buttons \(Custom Key Setting\)](#)
- [Microphone Directivity](#)

TC/UB



The time code (TC) and the user bit (UB) information can be recorded as data attached to movies.

- 1 MENU →  (Shooting) → [TC/UB] → **Select a menu item and set the desired parameter.**

Menu item details

Time Code Preset:

Sets the time code.

User Bit Preset:

Sets the user bit.

Time Code Format:

Sets the recording method for the time code. (Only when [NTSC/PAL Selector] is set to NTSC.)

Time Code Run:

Sets the count up format for the time code.

Time Code Make:

Sets the recording format for the time code on the recording medium.

User Bit Time Rec:

Sets whether or not to record the time as a user bit.

How to set the time code (Time Code Preset)

1. MENU →  (Shooting) → [TC/UB] → [Time Code Preset].
2. Turn the control wheel and select the first two digits.

- The time code can be set between the following range.



When [60p] is selected: 00:00:00.00 to 23:59:59.29

* When [24p] is selected, you can select the last two digits of the time code in multiples of four from 00 to 23 frames.

When [50p] is selected: 00:00:00.00 to 23:59:59.24

3. Set the other digits following the same procedure as in step 2, then press in the center of the control wheel.



How to reset the time code

1. MENU →  (Shooting) → [TC/UB] → [Time Code Preset].
2. Press the  (Delete) button to reset the time code (00:00:00.00).

How to set the user bit (User Bit Preset)

1. MENU →  (Shooting) → [TC/UB] → [User Bit Preset].
2. Turn the control wheel and select the first two digits.
3. Set the other digits following the same procedure as in step 2, then press in the center of the control wheel.

How to reset the user bit

1. MENU →  (Shooting) → [TC/UB] → [User Bit Preset].
2. Press the  (Delete) button to reset the user bit (00 00 00 00).

How to select the recording method for the time code (Time Code Format ^{*1})

1. MENU →  (Shooting) → [TC/UB] → [Time Code Format].

DF:

Records the time code in Drop Frame ^{*2} format.

NDF:

Records the time code in Non-Drop Frame format.

^{*1} Only when [NTSC/PAL Selector] is set to NTSC.

^{*2} The time code is based on 30 frames per second. However, a gap between the actual time and the time code will occur during extended periods of recording as the frame frequency of the NTSC image signal is approximately 29.97 frames per second. Drop frame corrects this gap to make the time code and actual time equal. In drop frame, the first 2 frame numbers are removed every minute except for every tenth minute. The time code without this correction is called non-drop frame.

- The setting is fixed to [-] when recording in 24p.

How to select the count up format for the time code (Time Code Run)

1. MENU →  (Shooting) → [TC/UB] → [Time Code Run].

Rec Run:

Sets the stepping mode for the time code to advance only while recording. The time code is recorded sequentially from the last time code of the previous recording.

Free Run:

Sets the stepping mode for the time code to advance anytime, regardless of the camera operation.

- The time code may not be recorded sequentially in the following situations even when the time code advances in [Rec Run] mode.
 - When the recording format is changed.
 - When the recording medium is removed.

How to select how the time code is recorded (Time Code Make)

1. MENU →  (Shooting) → [TC/UB] → [Time Code Make].

Preset:

Records the newly set time code on the recording medium.

Regenerate:

Reads the last time code for the previous recording from the recording medium and records the new time code consecutively from the last time code. The time code advances in [Rec Run] mode regardless of the [Time Code Run] setting.

Related Topic

- [TC/UB Disp. Setting](#)

TC/UB Disp. Setting



Sets the display of the recording time counter, time code (TC), and user bit (UB) for movies.

① **MENU** →  (**Setup**) → [**Display Option**] → [**TC/UB Disp. Setting**] → **desired setting**.

Menu item details

Counter:

Displays the time counter of movie recording.

TC:

Displays the time code.

U-Bit:

Displays the user bit.

Related Topic

- [TC/UB](#)

Livestreaming video and audio (USB Streaming)



You can connect a computer, etc. to the camera and use the camera video and audio for livestreaming or web-conferencing services. Select MENU →  (Setup) → [USB] → [USB Connection Mode] → [Sel. When Connect] or [USB Streaming] beforehand.

1 Connect the camera to a computer or other device with a commercially available USB cable.

[USB Streaming:Standby] will appear on the camera screen, and the camera will switch to the streaming standby state.



- If [USB Connection Mode] is set to [Sel. When Connect], select [Live Stream(USB Streaming)] on the selection screen for the USB connection mode.
- Use a cable or adapter that matches the terminal on the device to be connected.

2 Start streaming from your livestreaming/web-conferencing service.

[USB Streaming:Output] will appear on the camera screen.



- To exit [USB Streaming], turn off the power of the camera or disconnect the USB cable.

Hint

- If you assign [Product Showcase Set] or [Background Defocus] to [ Custom Key Setting], you can use these functions even during USB streaming.
- The format of the streaming data is as follows.
 - Video format: MJPEG
 - Resolution: HD720 (1280×720)
 - Frame rate: 30 fps / 25 fps
 - Audio format: LPCM, 48 kHz, 16 bit, 2 ch
- During USB streaming, power is supplied to the camera from the computer. If you want to consume as little computer power as possible, set [USB Power Supply] to [Off].
- When using an external microphone, you can minimize deviations between your voice and the movements of your mouth by connecting the microphone to the  (microphone) terminal of the camera.

Note

- While USB streaming is in progress, the camera is always set to the movie recording mode regardless of the shooting mode before the start of streaming.
- You cannot do the following while [USB Streaming] is running.
 - Transition to the playback screen
 - Network functions (PC remote, remote operation from a smartphone, etc.)
- The following functions are disabled while [USB Streaming] is running.
 - Recording the streaming video
 - Menu-screen operations

- Capturing a custom white balance
-  Picture Profile
- Power Save Start Time
-  Auto Monitor OFF

Related Topic

- [USB Connection Mode](#)

5-049-603-11(1) Copyright 2023 Sony Corporation

Digital Camera
ZV-1M2

Contents of this chapter

The following table of contents lists the features described in this chapter (“Customizing the camera”). From each item name, you can jump to the page describing the respective functions.

[Assigning frequently used functions to buttons \(Custom Key Setting\)](#)

Registering and recalling camera settings

- [Camera Set. Memory](#)
- [Recalling registered shooting settings \(Cam.Set\)](#)

Registering frequently used functions to the function menu

- [Fn Menu Settings](#)

Registering frequently used functions to My Menu

- [Add Item](#)
- [Sort Item](#)
- [Delete Item](#)
- [Delete Page](#)
- [Delete All](#)
- [Display From My Menu](#)

Recording movies by pressing the shutter button

- [REC w/ Shutter \(movie\)](#)

Monitor settings

- [Monitor Flip Direction](#)
- [DISP \(Screen Disp\) Set](#)

Assigning frequently used functions to buttons (Custom Key Setting)





You can use the custom key function to assign the functions you use most frequently to easily operable buttons. This lets you skip the process of selecting items from MENU, so you can recall the functions more quickly.

You can separately assign functions to custom keys for the still image shooting mode, movie shooting mode, and playback mode.



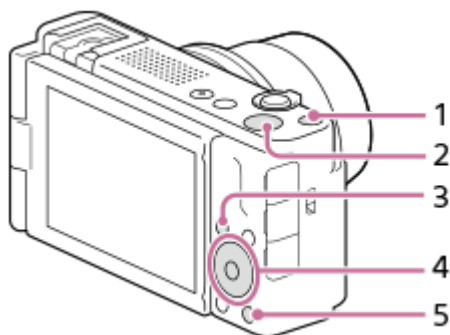

- Assignable functions vary depending on the buttons.

You can assign functions to the following buttons.



1. Custom Button 1
2. MOVIE Button
3. Fn/  Button
4. Center Button/Left Button/Right Button
5.  Button

The following is the procedure for assigning the [Subject Recognition AF] function to the center button.



- 1** MENU →  (Setup) → [Operation Customize] → [ Custom Key Setting].
 - If you want to assign a function to recall while shooting movies, select [ Custom Key Setting]. If you want to assign a function to recall while playing back images, select [ Custom Key Setting].
- 2** Move to the [Rear] screen using the top/bottom side of the control wheel. Then, select [Center Button] and press the center of the control wheel.
- 3** Select [Subject Recognition AF] using the top/bottom/left/right side of the control wheel, and then press the center.
 - If you press the center button while shooting and eyes are detected, [Subject Recognition AF] will activate and the camera will focus on the eyes. Shoot images while holding down the center button.

Digital Camera
ZV-1M2

Camera Set. Memory



Allows you to register up to 3 often-used modes or product settings per shooting mode (Still/Movie/S&Q Motion) to the product and up to 4 (M1 through M4) to the memory card. You can recall the settings during shooting.

- 1 Set the product to the setting you want to register.
- 2 MENU →  /  (Shooting) → [Shooting Mode] → [ Camera Set. Memory] → desired number.
- 3 Press the center of the control wheel to confirm.

Items that can be registered

- You can register various functions for shooting. The items that can actually be registered are displayed on the menu of the camera.
- Aperture (F number)
- Shutter speed
- Optical zoom scale

To change registered settings

Change the setting to the desired one and re-register the setting to the same mode number.

Note

- M1 through M4 can be selected only when a memory card is inserted into the product.
- Program Shift cannot be registered.

Related Topic

- [Recalling registered shooting settings \(Cam.Set\)](#)

Recalling registered shooting settings (Cam.Set)



Allows you to shoot an image after recalling your preferred shooting settings registered with [**MR** Camera Set. Memory].

1 Press the Still/Movie/S&Q button to select the desired shooting mode.

2 MENU → / (Shooting) → [Shooting Mode] → [Shoot Mode]/[Shoot Mode]/[Shoot Mode] → [**MR** Cam.Set] → desired number.

Hint

- Settings registered to a memory card using another camera of the same model name can be recalled with this camera.

Note

- If you perform [**MR** Cam.Set] after completing the shooting settings, the registered settings will be given priority and the original settings may become invalid. Check the indicators on the screen before shooting.

Related Topic

- [Camera Set. Memory](#)

Fn Menu Settings



The Function menu is a menu of 12 functions that is displayed at the bottom of the screen when you press the Fn (Function) button in the shooting mode.

You can register 12 functions to the Function menus for still image shooting and movie shooting, respectively.

The following is the procedure for changing [Drive Mode] in the still image function menu to [Grid Line Display].

- To change the movie function menu, select a movie function menu item in Step 2.

- 1 MENU** → (Setup) → [Operation Customize] → select [Fn Menu Settings].
- 2** Select (Drive Mode) from among the 12 still image function menu items using the top/bottom/left/right side of the control wheel, and then press the center.
- 3** Move to the screen showing [Grid Line Display] using the left/right side of the control wheel. Then, select [Grid Line Display] and press the center of the control wheel.
 - (Grid Line Display) will be displayed in the former location of (Drive Mode) in the Function menu.

Hint

- When [Touch Operation] is set to [On] and [Shooting Screen] is set to [On], you can also open [Fn Menu Settings] by holding down the icon in the function menu.

Related Topic

- [Fn \(function\) button](#)

Digital Camera
ZV-1M2

Add Item



You can register the desired menu items to ☆ (My Menu) under MENU.

- 1 MENU → ☆ (My Menu) → [My Menu Setting] → [Add Item].
- 2 Select an item that you want to add to ☆ (My Menu) using the top/bottom/left/right sides of the control wheel.
- 3 Select a destination using the top/bottom/left/right sides of the control wheel.

Hint

- You can add up to 42 items to ☆ (My Menu).

Note

- You cannot add the following items to ☆ (My Menu).
 - Any item under MENU →  (Playback)

Related Topic

- [Sort Item](#)
- [Delete Item](#)
- [MENU button](#)

Sort Item



You can rearrange the menu items added to ☆ (My Menu) under MENU.

- 1 MENU → ☆ (My Menu) → [My Menu Setting] → [Sort Item].
 - 2 Select an item that you want to move using the top/bottom/left/right sides of the control wheel.
 - 3 Select a destination using the top/bottom/left/right sides of the control wheel.
-
-

Related Topic

- [Add Item](#)

Delete Item



You can delete menu items added to ☆ (My Menu) of MENU.

- 1 MENU → ☆ (My Menu) → [My Menu Setting] → [Delete Item].
- 2 Select an item that you want to delete using the top/bottom/left/right sides of the control wheel, and then press the center to delete the selected item.

Hint

- To delete all the items on a page, select MENU → ☆ (My Menu) → [My Menu Setting] → [Delete Page].
- You can delete all the items added to ☆ (My Menu) by selecting MENU → ☆ (My Menu) → [My Menu Setting] → [Delete All].

Related Topic

- [Delete Page](#)
- [Delete All](#)
- [Add Item](#)

Delete Page



You can delete all the menu items added to a page under ☆ (My Menu) in MENU.

- 1 MENU → ☆ (My Menu) → [My Menu Setting] → [Delete Page].
- 2 Select a page that you want to delete using the top/bottom sides of the control wheel, and then press the center of the control wheel to delete the items.

Related Topic

- [Delete All](#)
- [Add Item](#)

Digital Camera
ZV-1M2

Delete All



You can delete all the menu items added to ☆ (My Menu) in MENU.

1 MENU → ☆ (My Menu) → [My Menu Setting] → [Delete All].

2 Select [OK].

Related Topic

- [Delete Page](#)
- [Add Item](#)

Display From My Menu



You can set My Menu to appear first when you press the MENU button.

① MENU → ☆ (My Menu) → [My Menu Setting] → [Display From My Menu] → desired setting.

Menu item details

On:

My Menu appears first when you press the MENU button.

Off:

The most recently displayed menu appears when you press the MENU button.

Related Topic

- [Add Item](#)
- [MENU button](#)

Digital Camera
ZV-1M2

REC w/ Shutter (movie)



You can start or stop recording movies by pressing the shutter button, which is bigger and easier to press than the MOVIE (Movie) button.

1 MENU →  (Setup) → [Operation Customize] → [ REC w/ Shutter] → desired setting.

Menu item details

On:

Enables movie recording using the shutter button when the shooting mode is set to [Movie] or [S&Q Motion].

Off:

Disables movie recording using the shutter button.

Hint

- When [ REC w/ Shutter] is set to [On], you can use the shutter button to start or stop recording movies on an external recording/playback device using [REC Control].

Related Topic

- [Shooting movies \(Intelligent Auto\)](#)

Digital Camera
ZV-1M2

Monitor Flip Direction



The direction of image and menu screen displays can be inverted according to how the monitor is opened and the orientation of the monitor.

1 MENU →  (Setup) → [Monitor] → [Monitor Flip Direction] → desired setting.

Menu item details

Auto:

Inverts the direction of the display of the monitor by detecting how the monitor is opened and the orientation of the monitor.

Horizontal Flip:

Flips the display of the monitor horizontally when shooting.

180 Degree Flip:

Rotates the display of the monitor 180 degrees for all kinds of displays such as images and menu screens.

No Flip:

Does not invert the display of the monitor.

Hint

- By repeatedly pressing the key to which the [Switch Monitor Flip Disp] function is assigned, you can switch the setting in the order of [Horizontal Flip] → [180 Degree Flip] → [No Flip] → [Horizontal Flip]. When [Monitor Flip Direction] is set to [Auto], the display method is temporarily switched while the setting value remains [Auto].

Note

- Even if [Monitor Flip Direction] is set to [Horizontal Flip], the direction of the monitor display during playback will not be inverted.

DISP (Screen Disp) Set



Allows you to set the screen display modes that can be selected using DISP (Display Setting) in shooting mode.

1 MENU →  (Setup) → [Operation Customize] → [DISP (Screen Disp) Set] → desired setting → [Enter].

The items marked with ✓ (check) are available.

Menu item details

Display All Info. :

Shows recording information.

No Disp. Info. :

Does not show recording information.

Histogram :

Displays the luminance distribution graphically.

Level :

Indicates whether the product is level in both the front-back **(A)** and horizontal **(B)** directions. When the product is level in either direction, the indicator turns to green.

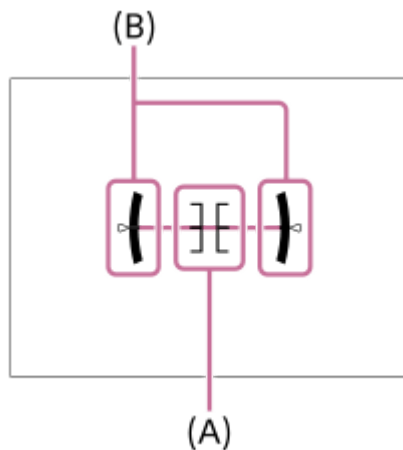

Note

- If you tilt the product forward or backward by a large degree, the level error will be great.
- The product may have a margin of error of almost $\pm 1^\circ$ even when the inclination is corrected by the level.

Related Topic

- [DISP \(Display Setting\) button](#)

Contents of this chapter

The following table of contents lists the features described in this chapter (“Viewing”). From each item name, you can jump to the page describing the respective functions.

Viewing images

- [Playing back still images](#)
- [Enlarging an image being played back \(Enlarge Image\)](#)
- [Enlarge Initial Mag.](#)
- [Enlarge Initial Position](#)
- [Rotating recorded images automatically \(Display Rotation\)](#)
- [Playing back movies](#)
- [Volume Settings](#)
- [Playing back images using slideshow \(Slide Show\)](#)
- [Cont. Play for Interval](#)
- [Play Speed for Interval](#)

Changing how images are displayed

- [Playing back images on the image index screen \(Image Index\)](#)
- [Switching between still images and movies \(View Mode\)](#)
- [Display as Group](#)
- [Disp Specified Time Img.](#)

Protecting recorded images (Protect)

Adding information to images

- [Rating](#)
- [Rating Set\(Custom Key\)](#)
- [Rotating an image \(Rotate\)](#)

Extracting still images from a movie

- [Photo Capture](#)

Deleting images

- [Deleting multiple selected images \(Delete\)](#)
- [Delete pressing twice](#)
- [Delete confirm.](#)

Viewing images on a TV

- [Viewing images on a TV using an HDMI cable](#)

Playing back still images

Plays back the recorded images.

1 Press the (Playback) button to switch to the playback mode.

You can touch  (Playback) on the screen to switch to the playback mode.



If the touch function icons are not displayed, swipe left or right on the monitor to display them.

For details, refer to "[Touch function icons](#)."

2 Select the image with the control wheel.

- Images shot with continuous shooting or interval shooting are displayed as one group. To play back the images in the group, press the center of the control wheel.

Hint

- The product creates an image database file on a memory card to record and play back images. An image that is not registered in the image database file may not be played back correctly. To play back images shot using other devices, register those images to the image database file using MENU →  /  (Shooting) → [Media] →  Recover Image DB].
- If you play back the images right after continuous shooting, the monitor may display an icon indicating that data is being written/the number of images left to write. During writing, some functions are not available.

Related Topic



- [Recover Image DB \(still image/movie\)](#)
- [Display as Group](#)
- [Enlarging an image being played back \(Enlarge Image\)](#)
- [Touch function icons](#)

Enlarging an image being played back (Enlarge Image)

Enlarges the image being played back. Use this function to check the focus of the image, etc.

- 1 Display the image you want to enlarge, and slide the W/T (zoom) lever to the T side.**
 - Slide the W/T (zoom) lever to the W side to adjust the zoom scale.
 - The view will zoom in on the part of the image where the camera focused during shooting. If the focus location information cannot be obtained, the camera will zoom in on the center of the image.
- 2 Select the portion you want to enlarge by pressing the top/bottom/right/left sides of the control wheel.**
- 3 Press the MENU button or the center of the control wheel to exit the playback zoom.**

Hint

- You can also enlarge an image being played back using MENU.
- You can change the initial magnification and initial position of enlarged images by selecting MENU →  (Playback) → [Magnification] → [ Enlarge Initial Mag.] or [ Enlarge Initial Position].
- You can also enlarge the image by touching the monitor. Drag the monitor to move the enlarged position. Set [Touch Operation] to [On] and [Playback Screen] to [On] beforehand.

Note

- You cannot enlarge movies.

Related Topic

- [Enlarge Initial Mag.](#)
- [Enlarge Initial Position](#)
- [Touch Operation](#)
- [Playback Screen](#)

Enlarge Initial Mag.

Sets the initial magnification scale when playing back enlarged images.

1 MENU →  (Playback) → [Magnification] → [ Enlarge Initial Mag.] → desired setting.

Menu item details

Standard. Mag.:

Displays an image with the standard magnification.

Previous Mag.:



Displays an image with the previous magnification. The previous magnification is stored even after the enlarged display screen is closed.

Related Topic

- [Enlarging an image being played back \(Enlarge Image\)](#)
- [Enlarge Initial Position](#)

Enlarge Initial Position

Sets the initial position when enlarging an image in playback.

1 MENU →  (Playback) → [Magnification] → [ Enlarge Initial Position] → desired setting.

Menu item details

Focused Position:

Enlarges the image from the point of focus during shooting.

Center:

Enlarges the image from the center of the screen.

Related Topic

- [Enlarging an image being played back \(Enlarge Image\)](#)
- [Enlarge Initial Mag.](#)

Digital Camera
ZV-1M2

Rotating recorded images automatically (Display Rotation)

Selects the orientation when playing back recorded images.

1 MENU →  (Playback) → [Playback Option] → [Display Rotation] → desired setting.

Menu item details

Auto:

When you rotate the camera, the camera detects the vertical and horizontal directions, and displays the image being played back according to the orientation.

Manual:

Images shot vertically are displayed vertically. If you have set the image orientation using the [Rotate] function, the image will be displayed accordingly.

Off:

Images are always displayed horizontally.

Note

- Movies shot vertically are played back horizontally during movie playback.

Related Topic

- [Rotating an image \(Rotate\)](#)













Playing back movies

Plays back the recorded movies.



- 1 Press the  (playback) button to switch to playback mode.
- 2 Select the movie to be played back using the control wheel and press the center of the control wheel to start playback.

Available operations during movie playback

You can perform slow playback and sound volume adjustment, etc. by pressing the down side of the control wheel.

-  : Playback
-  : Pause
-  : Fast-forward
-  : Fast-rewind
-  : Forward slow playback
-  : Reverse slow playback
-  : Next movie file
-  : Previous movie file
-  : Displays the next frame
-  : Displays the previous frame
-  : Photo Capture
-  : Sound volume adjustment
-  : Closes the operation panel

Hint

- The product creates an image database file on a memory card to record and play back images. An image that is not registered in the image database file may not be played back correctly. To play back images shot using other devices, register those images to the image database file using MENU →  /  (Shooting) → [Media] → [ Recover Image DB].
- “Forward slow playback,” “Reverse slow playback,” “Displays the next frame” and “Displays the previous frame” are available during pause.
- Movie files recorded using other products may not be playable on this camera.
- For movies with Shot Marks, the positions of the Shot Marks are displayed on the playback bar during movie playback. In addition, the Shot Mark icon is displayed on the screen when a scene to which a Shot Mark was added is played back.

Note

- Even if you shoot the movie vertically, the movie will be displayed horizontally on the screen of the camera.

Related Topic

- [Recover Image DB \(still image/movie\)](#)
- [Switching between still images and movies \(View Mode\)](#)

Digital Camera
ZV-1M2

Volume Settings

Sets the sound volume for movie playback.

① **MENU** →  (**Setup**) → **[Sound Option]** → **[Volume Settings]** → **desired setting**.

Adjusting the volume during playback

Press the bottom side of the control wheel while playing back movies to display the operation panel, then adjust the volume. You can adjust the volume while listening to the actual sound.

Digital Camera
ZV-1M2

Playing back images using slideshow (Slide Show)

Automatically plays back images continuously.

- 1 MENU →  (Playback) → [Viewing] → [Slide Show] → desired setting.
- 2 Select [Enter].

Menu item details

Repeat:

Select [On], in which images are played back in a continuous loop, or [Off], in which the product exits the slideshow when all the images are played back once.

Interval:

Select the display interval for images from among [1 Sec], [3 Sec], [5 Sec], [10 Sec] or [30 Sec].

To quit the slideshow in the middle of playback

Press the MENU button to quit the slideshow. You cannot pause the slideshow.

Hint



- During playback, you can display the next/previous image by pressing the right/left side of the control wheel.
- You can activate a slideshow only when [View Mode] is set to [Date View] or [Folder View(Still)].

Digital Camera
ZV-1M2



Cont. Play for Interval

Continuously plays back images shot using interval shooting.

You can create movies from still images produced by interval shooting using the computer software Imaging Edge Desktop(Viewer). You cannot create movies from the still images on the camera.

- 1 MENU →  (Playback) → [Viewing] → [Cont. Play for  Interval].
- 2 Select the image group that you want to play back, and then press the center of the control wheel.

Hint

- On the playback screen, you can start continuous playback by pressing the down button while displaying an image in the group.
- You can resume play or pause by pressing the down button during playback.
- You can change the playback speed by turning the control wheel during playback. You can also change the playback speed by selecting MENU →  (Playback) → [Viewing] → [Play Speed for  Interval].
- You can continuously play back images shot with continuous shooting as well.



Related Topic

- [Interval Shoot Func.](#)
- [Play Speed for Interval](#)
- [Introduction to computer software \(Imaging Edge Desktop/Catalyst\)](#)

Digital Camera
ZV-1M2

Play Speed for Interval

Sets the playback speed for still images during [Cont. Play for  Interval].

1 MENU →  (Playback) → [Viewing] → [Play Speed for  Interval] → desired setting.

Hint

- You can also change the playback speed by turning the control wheel during [Cont. Play for  Interval].

Related Topic

- [Cont. Play for Interval](#)

Playing back images on the image index screen (Image Index)

You can display multiple images at the same time in playback mode.

- 1 Slide the W/T (zoom) lever to the W side while the image is being played back.
- 2 Select the image by pressing the top/bottom/right/left sides of the control wheel or turning the control wheel.

To change the number of images to be displayed

MENU →  (Playback) → [Playback Option] → [Image Index] → desired setting.

Menu item details

9 Images/25 Images

To return to single-image playback

Select the desired image and press the center of the control wheel.

To display a desired image quickly

Select the bar on the left of the image index screen using the control wheel, then press the top/bottom sides of the control wheel. While the bar is being selected, you can display the calendar screen or folder selection screen by pressing the center. In addition, you can switch View Mode by selecting an icon.

Related Topic

- [Switching between still images and movies \(View Mode\)](#)

Digital Camera
ZV-1M2

Switching between still images and movies (View Mode)

Sets the View Mode (image display method).

① MENU →  (Playback) → [Playback Target] → [View Mode] → desired setting.

Menu item details

Date View:

Displays the images by date.

Folder View(Still):

Displays only still images.

Movie View:

Displays only movies by date.

Display as Group

Sets whether or not to display continuously shot images or images shot using interval shooting as a group.

1 MENU →  (Playback) → [Playback Option] → [Display as Group] → desired setting.

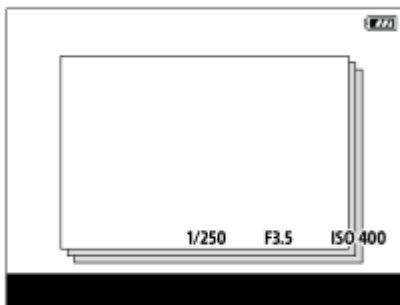

Menu item details

On:

Displays images as a group.

To play back the images in a group, select the group and press the center of the control wheel.

Off:

Does not display images as a group.

Hint

- The following images are grouped.
 - Images shot with [Drive Mode] set to [Cont. Shooting] (One sequence of images shot continuously by holding down the shutter button during continuous shooting becomes one group.)
 - Images shot with [Interval Shoot Func.] (Images shot during one session of interval shooting become one group.)
- On the image index screen,  (Display as Group) icon is displayed over the group.

Note

- If you delete the group, all the images in the group will be deleted.

Related Topic

- [Cont. Shooting](#)
- [Interval Shoot Func.](#)

Disp Specified Time Img.

You can play back images by specifying the shooting date and time.

- 1 MENU** →  **(Playback)** → **[Playback Option]** → **[Disp Specified Time Img.]**.
- 2 Set the date and time of the image to be played back using the control wheel, and then press the center.**

The image shot on the specified date and time will be played back.

 - If there are no images shot on the specified date and time, the image shot on the closest date and time will be played back.

Note

- When [Disp Specified Time Img.] is performed while playing back images in a group, the image shot on the closest date and time in the group is played back.
- For movies, the date and time when the recording was started are treated as the shooting date and time.

Protecting recorded images (Protect)



Protects recorded images against accidental erasure. The  (protect) mark is displayed on protected images.

1 MENU →  (Playback) → [Selection/Memo] → [Protect] → desired setting.

Menu item details

Multiple Img.:

Applies the protection of the selected multiple images.

(1) Select the image to be protected, then press the center of the control wheel. The  (check) mark is displayed in the check box. To cancel the selection, press the center again to remove the  (check) mark.

(2) To protect other images, repeat step (1).

(3) MENU → [OK].

All in this Folder:

Protects all images in the selected folder.

Cancel All in this Folder:

Cancels the protection of all images in the selected folder.

All with this date:

Protects all images taken on the selected date.

Cancel All with this date:

Cancels the protection of all images taken on the selected date.



All Images in This Group:

Protects all the images in the selected group.

Cancel All in This Group:

Cancels the protection of all the images in the selected group.

Hint

- If you assign [Protect] to the key of your choice using MENU →  (Setup) → [Operation Customize] → [ Custom Key Setting], you can protect images or cancel protection by simply pressing the key.
- If you select a group in [Multiple Img.], all the images in the group will be protected. To select and protect particular images within the group, execute [Multiple Img.] while displaying the images within the group.

Note

- The menu items that can be selected vary according to the [View Mode] setting and the selected content.

Rating

You can assign ratings to recorded images on a scale of the number of stars (★ - ★★★) to make it easier to find images.

1 MENU →  (Playback) → [Selection/Memo] → [Rating].

The image rating selection screen will appear.

2 Press the left/right sides of the control wheel to display an image to which you want to assign a rating, and then press the center.

3 Select the level of ★ (Rating) by pressing the left/right side of the control wheel, and then press the center.

4 Press the MENU button to exit the rating setting screen.

To set ratings when shooting still images

Assign [Add Rating (★)] through [Add Rating (★★★)] to the desired keys using [ Custom Key Setting] in advance and press the custom keys after shooting a still image. You can set the rating for the last shot still image.

- Ratings cannot be set when shooting movies.

Hint

- You can also assign ratings when playing back images by using the custom key. Assign [Rating] to the desired key using [ Custom Key Setting] beforehand, and then press the custom key while playing back an image to which you want to assign a rating. The level of ★ (Rating) changes each time you press the custom key.

Related Topic

- [Assigning frequently used functions to buttons \(Custom Key Setting\)](#)
- [Rating Set\(Custom Key\)](#)

Digital Camera
ZV-1M2

Rating Set(Custom Key)

Sets the available number of ★ (rating) when rating (ranking) images with the key to which you have assigned [Rating] using [ Custom Key Setting].

- 1 MENU →  (Playback) → [Selection/Memo] → [Rating Set(Custom Key)].
 - 2 Add a ✓ (check) mark to the number of ★ (rating) that you want to activate.
You can select the checked number when setting [Rating] using the custom key.
-

Related Topic

- [Rating](#)
- [Assigning frequently used functions to buttons \(Custom Key Setting\)](#)

Rotating an image (Rotate)

Rotates a recorded image counter-clockwise.

1 Display the image to be rotated, then select **MENU** →  (**Playback**) → **[Edit]** → **[Rotate]**.

2 Press the center of the control wheel.

The image is rotated counter-clockwise. The image rotates as you press the center.



If you rotate the image once, the image remains rotated even after the product is turned off.

Note

- Even if you rotate a movie file, it will be played back horizontally on the monitor of the camera.
- You may not be able to rotate images shot using other products.
- When viewing rotated images on a computer, the images may be displayed in their original orientation depending on the software.

Photo Capture

Captures a chosen scene in a movie to save as a still image. First shoot a movie, then pause the movie during playback to capture decisive moments that tend to be missed when shooting still images, and save them as still images.

- 1 **Display the movie that you want to capture as a still image.**
- 2 **MENU** →  (**Playback**) → [**Edit**] → [**Photo Capture**].
- 3 **Play back the movie and pause it.**
- 4 **Find the desired scene using forward slow playback, reverse slow playback, displays the next frame, and displays the previous frame, and then stop the movie.**
- 5 **Press  (Photo Capture) to capture the chosen scene.**
The scene is saved as a still image.

Related Topic

- [Shooting movies \(Intelligent Auto\)](#)
- [Playing back movies](#)

Deleting multiple selected images (Delete)

You can delete multiple selected images. Once you have deleted an image, you cannot restore it. Confirm the image to be deleted beforehand.

① MENU →  (Playback) → [Delete] → [Delete] → desired setting.

Menu item details

All Other Than This Img.:



Deletes all images in the group except the selection.

All Images in This Group:

Deletes all images in the selected group.

Multiple Img.:

Deletes the selected images.

(1) Select the images to be deleted, then press the center of the control wheel. The  (check) mark is displayed in the check box. To cancel the selection, press the center again to remove the  (check) mark.

(2) To delete other images, repeat step (1).

(3) MENU → [OK].

All in this Folder:

Deletes all images in the selected folder.

All with this date:

Deletes all images taken on the selected date.

Hint

- Perform [Format] to delete all images, including protected images.
- To display the desired folder or date, select the desired folder or date during playback by performing the following procedure:
 (Image Index) lever → select the bar on the left using the control wheel → select the desired folder or date using the top/bottom sides of the control wheel.
- If you select a group in [Multiple Img.], all the images in the group will be deleted. To select and delete particular images within the group, execute [Multiple Img.] while displaying the images within the group.

Note

- The protected images cannot be deleted.
- The menu items that can be selected vary according to the [View Mode] setting and the selected content.

Related Topic

- [Display as Group](#)
- [Delete button](#)
- [Format](#)

Digital Camera
ZV-1M2

Delete pressing twice

Sets whether or not you can delete the image currently being played back by pressing the  (Delete) button twice in sequence.

① MENU →  (Playback) → [Delete] → [ Delete pressing twice] → desired setting.

Menu item details

On:

Enables you to delete the image currently being played back by pressing the  (Delete) button twice.

Off:

Does not enable you to delete the image currently being played back by pressing the  (Delete) button twice.

Digital Camera
ZV-1M2

Delete confirm.

You can set whether [Delete] or [Cancel] is selected as a default on the delete confirmation screen.

① **MENU** →  **(Playback)** → **[Delete]** → **[Delete confirm.]** → **desired setting.**

Menu item details

"Delete" first:

[Delete] is selected as the default setting.

"Cancel" first:

[Cancel] is selected as the default setting.

Viewing images on a TV using an HDMI cable

To view images stored on this product using a TV, an HDMI cable (sold separately) and a TV equipped with an HDMI jack are required. For details, refer to the operating instructions supplied with the compatible TV.

1 Turn off both this product and the TV.

2 Connect the HDMI terminal of this product to the HDMI jack of the TV using an HDMI cable (sold separately).

Use an HDMI cable that is compatible with the HDMI Type-D micro jack of the product and the HDMI jack of the TV.

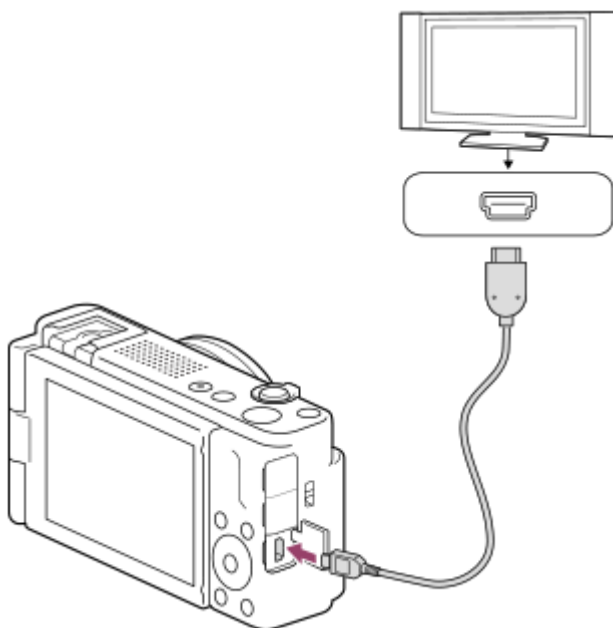

3 Turn on the TV and switch the input.

4 Turn on this product.





Images shot with the product appear on the TV screen.

5 Select an image using the right/left sides of the control wheel.

- The monitor of this camera is not lit up on the playback screen.
- If the playback screen is not displayed, press the  (Playback) button.

Note



- Do not connect this product and another device using the output terminals of both. Doing so may cause a malfunction.
- Some devices may not work properly when connected to this product. For example, they may not output video or audio.
- Use an HDMI cable with the HDMI logo or a genuine Sony cable.

- When [Time Code Output] is set to [On], the image may not be output properly to the TV or recording device. In such cases, set [Time Code Output] to [Off].
- If images do not appear on the TV screen properly, select MENU →  (Setup) → [External Output] → [ HDMI Resolution] → [2160p/1080p], [1080p] or [1080i] according to the TV to be connected.
- During HDMI output, when you switch the movie from 4K to HD image quality or vice-versa, or change the movie to a different frame rate or different color mode, the screen may become dark. This is not a malfunction.
- When [ Proxy Recording] under [ Proxy Settings] is set to [On], images cannot be output to an HDMI device during 4K movie recording.
- If the product performs unwanted operations in response to the TV remote control, select MENU →  (Setup) → [External Output] → [CTRL FOR HDMI] → [Off].

Digital Camera
ZV-1M2

Format

When you use a memory card with this camera for the first time, we recommend that you format the card using the camera for stable performance of the memory card. Note that formatting permanently erases all data on the memory card, and is unrecoverable. Save valuable data on a computer, etc.

- 1 MENU →  /  (Shooting) → [Media] → [Format].
- 2 Select [Enter]. (Quick formatting)
 - If you press the  (Delete) button, a message to perform full formatting will be displayed. You can launch full formatting by selecting [Enter].

The difference between quick formatting and full formatting

Perform full formatting when you feel like the speed of recording to the memory card or read-out from the memory card has become slow, or when you want to erase data completely, etc.

Full formatting takes longer than quick formatting, because all areas of the memory card are initialized.

Hint

- You can cancel full formatting before it is completed. Even if you cancel full formatting in the middle of the process, the data will be erased, so you can use the memory card as is.

Note

- Formatting permanently erases all data including protected images and registered settings (from M1 to M4).
- The access lamp lights up during formatting. Do not remove the memory card while the access lamp is lit up.
- Format the memory card on this camera. If you format the memory card on the computer, the memory card may not be usable depending on the format type.
- It may take a few minutes to complete formatting, depending on the memory card.
- If the battery pack is extremely depleted, formatting cannot be performed. Use a sufficiently charged battery pack.

Related Topic

- [Memory cards that can be used](#)
- [Notes on memory card](#)

Digital Camera
ZV-1M2

Recover Image DB (still image/movie)

If image files were processed on a computer, problems may occur in the image database file. In such cases, the images on the memory card will not be played back on this product. Also, if you use a memory card in the camera after using it in another device, the images on the memory card may not be played back correctly. For example, the images may not be displayed as a group. If these problems happen, repair the file using [ Recover Image DB].

Images recorded on the memory card are not deleted by [ Recover Image DB].

1 MENU →  /  (Shooting) → [Media] → [ Recover Image DB] → [Enter].



Note

- If the battery pack is extremely depleted, image database files cannot be repaired. Use a sufficiently charged battery pack.

Digital Camera
ZV-1M2

Display Media Info. (still image/movie)

Displays the recordable number of still images and the remaining recording time for movies on the memory card.

① **MENU** →  /  (**Shooting**) → [**Media**] → [ **Display Media Info.**].

Digital Camera
ZV-1M2

File/Folder Settings

Configure settings related to the folder and file name of the still image to be shot.

1 MENU →  (Shooting) → [File] → [File/Folder Settings] → desired setting.

Menu item details

File Number:

You can set how to assign file numbers to still images.

[Series]: Does not reset file numbers for each folder.

[Reset]: Resets file numbers for each folder.

Forced File Number Reset:

Resets the still image file number and creates a new folder.

Set File Name:

You can specify the first three characters of the file name.

Folder Name:

You can set how folder names are assigned.

[Standard Form]: Folders are named as “folder number + any 5 characters”. Example: 100MSDCF

[Date Form]: Folders are named as “folder number + Y (the last digit of the year)/MM/DD”.

Example: 10030405 (Folder number: 100; date: 04/05/2023)

Hint

- When [Folder Name] is set to [Standard Form], the last 5 characters of the folder name can be set using [Create New Folder].
- You can also change the last five characters of the folder name by using [Forced File Number Reset].

Note

- Only capital letters, numbers, and underscores can be used for [Set File Name]. Underscores cannot be used for the first character.
- The three characters specified using [Set File Name] are only applied to files recorded after the setting is made.

Related Topic

- [Create New Folder](#)
- [File Settings](#)

Select REC Folder

If [Folder Name] under [File/Folder Settings] is set to [Standard Form] and there are 2 folders or more, you can select the folder on the memory card to which images are to be recorded.

1 MENU →  (Shooting) → [File] → [Select REC Folder] → desired folder.

Note

- You cannot select the folder when [Folder Name] under [File/Folder Settings] is set to [Date Form].

Related Topic

- [File/Folder Settings](#)
- [Create New Folder](#)

Digital Camera
ZV-1M2

Create New Folder

Creates a new folder on the memory card for recording still images. A new folder is created with a folder number one greater than the largest folder number currently used. Images are recorded in the newly created folder.

Up to 4 000 images in total can be stored in one folder. When the folder capacity is exceeded, a new folder may be automatically created.

1 MENU →  (Shooting) → [File] → [Create New Folder].

Hint

- You can set the last 5 characters of the folder name.

Note

- When you insert a memory card that was used with other equipment into this product and shoot images, a new folder may be automatically created.
- You cannot change the folder name when [Folder Name] under [File/Folder Settings] is set to [Date Form].

Related Topic

- [File/Folder Settings](#)

Digital Camera
ZV-1M2

File Settings

Configure settings for the file names of recorded movies.

1 MENU →  (Shooting) → [File] → [File Settings] → desired setting item.

Menu item details

File Number:

You can set how to assign file numbers to movies.

[Series]: Does not reset file numbers even if the memory card is changed.

[Reset]: Resets the file number when the memory card is changed.

Series Counter Reset:

Resets the series counter used when [File Number] is set to [Series].

File Name Format:

You can set the format for movie file names.

[Standard]: The file name of the recorded movie starts with "C." Example: C0001

[Title]: The file name of the recorded movie becomes "Title+File number."

[Date + Title]: The file name of the recorded movie becomes "Date+Title+File number."

[Title + Date]: The file name of the recorded movie becomes "Title+Date+ File number."

Title Name Settings:

You can set the title when [File Name Format] is set to [Title], [Date + Title], or [Title + Date].

Note

- Only alphanumeric characters and symbols can be input for [Title Name Settings]. Up to 37 characters can be entered.
- Titles specified using [Title Name Settings] are only applied to movies recorded after the setting is made.
- You cannot set how folder names are assigned for movies.
- If you are using an SDHC memory card, [File Name Format] is locked to [Standard].
- If you insert a memory card used with [File Name Format] set to one of the following into another device, the memory card may not function properly.
 - [Title]
 - [Date + Title]
 - [Title + Date]
- If there are unused numbers due to file deletion, etc., these numbers will be reused when the movie file number reaches "9999."



Related Topic

- [File/Folder Settings](#)

Digital Camera
ZV-1M2

Write Serial Number (still image/movie)

Writes the camera's serial number when shooting.

① **MENU** →  /  (**Shooting**) → [**File**] → [ **Write Serial Number**] → **desired setting**.

Menu item details

On:

Writes the camera's serial number to the image.

Off:

Does not write the camera's serial number to the image.

Digital Camera
ZV-1M2

Display Wi-Fi Info.

Displays the camera's Wi-Fi MAC address.

1 MENU →  (Network) → [Wi-Fi] → [Display Wi-Fi Info.].

SSID/PW Reset

This product shares connection information with devices that have permission to connect when connecting to a smartphone. If you want to change which devices have permission to connect, reset the connection information.

1 MENU →  (Network) → [Wi-Fi] → [SSID/PW Reset] → [OK].

Note

- If you connect this product to a smartphone after resetting the connection information, you must make the settings for the smartphone again.

Related Topic

- [Operating the camera from a computer](#)

Digital Camera
ZV-1M2

Bluetooth Settings

Controls the settings for connecting the camera to a smartphone or Bluetooth remote commander or shooting grip via a Bluetooth connection.

① MENU →  (Network) → [Bluetooth] → Select a menu item and set the desired parameter.

Menu item details

Bluetooth Function:

Sets whether to activate or not the Bluetooth function of the camera. ([On]/[Off])

Pairing:

Displays the screen for pairing the camera and smartphone or Bluetooth remote commander.

Manage Paired Device:

Enables you to check or delete the pairing information for devices paired with the camera.

Bluetooth Rmt Ctrl:

Sets whether or not to use a Bluetooth compatible remote commander (sold separately). ([On]/[Off])

Disp Device Address:

Displays the BD address of the camera.

Note



- After you delete the pairing information for the camera from your smartphone, delete pairing information for the smartphone from the camera using [Manage Paired Device].

Related Topic

- [Bluetooth Rmt Ctrl](#)
- [Cnct. while Power OFF \(smartphone\)](#)
- [Pairing the camera with a smartphone \(Smartphone Connection\)](#)

Bluetooth Rmt Ctrl

You can operate the camera using a Bluetooth compatible remote commander (sold separately) or shooting grip (sold separately). For details on compatible remote commanders or shooting grips, visit the Sony website in your area, or consult your Sony dealer or local authorized Sony service facility.

- 1 On the camera, select **MENU** →  (**Network**) → **[Bluetooth]** → **[Bluetooth Function]** → **[On]**.
- 2 On the camera, select **MENU** →  (**Network**) → **[Bluetooth]** → **[Bluetooth Rmt Ctrl]** → **[On]**.
 - If there is no Bluetooth device currently paired with the camera, the screen for pairing as described in Step 3 will appear.
- 3 On the camera, select **MENU** →  (**Network**) → **[Bluetooth]** → **[Pairing]** to display the screen for pairing.
- 4 On the Bluetooth remote commander, perform pairing.
 - For details, refer to the instruction manual for the Bluetooth remote commander.
- 5 On the camera, select **[OK]** on the confirmation screen for the Bluetooth connection.
 - Pairing is complete, and you can now operate the camera from the Bluetooth remote commander. After pairing the device once, you can connect the camera and the Bluetooth remote commander again in the future by setting **[Bluetooth Rmt Ctrl]** to **[On]**.

Menu item details

On:

Enables Bluetooth remote commander operation.

Off:

Disables Bluetooth remote commander operation.

Icons for Bluetooth connection

 (Bluetooth connection available): Bluetooth connection with the Bluetooth remote commander is established.



 (Bluetooth connection unavailable): Bluetooth connection with the Bluetooth remote commander is not established.

Icons displayed when connecting to a Bluetooth remote commander

 (remote commander mark): A Bluetooth remote commander can be used.

Hint

- The Bluetooth connection is only active while you are operating the camera using the Bluetooth remote commander.
- The Bluetooth icon is not displayed when the touch function icons are displayed in the movie recording mode. To see the Bluetooth icon, swipe the touch function icons left or right to hide the touch function icons.

- If the  (Bluetooth connection available) icon is displayed on the screen but  (remote commander mark) is not displayed, set [Bluetooth Rmt Ctrl] to [On] and follow the on-screen instructions.

Note

- When you initialize the camera, the pairing information is also deleted. To use the Bluetooth remote commander, perform pairing again.
- If the Bluetooth connection is unstable, remove any obstacles, such as people or metal objects from between the camera and the paired Bluetooth remote commander.
- The following functions cannot be used when [Bluetooth Rmt Ctrl] is set to [On].
 - Power-saving mode
- If the function does not work properly, check the following notes and then try pairing again.
 - Ensure that the camera is either not connected to any other device or connected to only one device using Bluetooth communication. (Up to 2 devices can be connected to the camera at the same time.)
 - Confirm that [Airplane Mode] for the camera is set to [Off].
 - If the function does not work properly even after you have performed the above operations, delete the pairing information for the device that you want to connect using [Manage Paired Device] on the camera.

Related Topic

- [Bluetooth Settings](#)

Digital Camera
ZV-1M2

Airplane Mode

When you board an airplane, etc., you can temporarily disable all the wireless-related functions including Wi-Fi.

1 MENU →  (Network) → [Network Option] → [Airplane Mode] → **desired setting.**

If you set [Airplane Mode] to [On], an airplane mark will be displayed on the screen.

Digital Camera
ZV-1M2

Edit Device Name

You can change the device name for Wi-Fi or Bluetooth connections.

- 1 **MENU** →  **(Network)** → **[Network Option]** → **[Edit Device Name]**.
 - 2 **Select the input box, then input the device name** → **[OK]**.
-

Related Topic

- [Keyboard screen](#)

Digital Camera
ZV-1M2

Reset Network Set.

Resets all the network settings to default settings.

[Airplane Mode] will not be reset to [Off] even if you perform [Reset Network Set.] when [Airplane Mode] is set to [On].

1 MENU →  (Network) → [Network Option] → [Reset Network Set.] → [Enter].

Digital Camera
ZV-1M2

Monitor Brightness

Adjust the brightness of the screen.

1 MENU →  (Setup) → [Monitor] → [Monitor Brightness] → desired setting.

Menu item details



Manual:

Adjusts the brightness within the range of -2 to +2.

Sunny Weather:

Sets the brightness appropriately for shooting outdoors.

Note

- The [Sunny Weather] setting is too bright for shooting indoors. Set [Monitor Brightness] to [Manual] for indoor shooting.
- The monitor brightness cannot be adjusted in the following situations. The maximum brightness will be [±0].
 - When [ File Format] is set to [XAVC S 4K].
 - When [ File Format] is set to [XAVC S HD] and [Rec Frame Rate] under [ Movie Settings] is set to [120p]/[100p].
- The monitor brightness is locked at [-2] when shooting a movie using the Wi-Fi functions.
- The monitor brightness is locked at [-2] when an overheating warning is displayed.

Auto Monitor OFF (still image)

Sets whether or not to turn the monitor off automatically in shooting modes for still images.

① **MENU** →  (Setup) → [Power Setting Option] → [ Auto Monitor OFF] → desired setting.

Menu item details

Does not turn OFF:

Does not turn the monitor off.

2 Sec/5 Sec/10 Sec:

Turns the monitor off after the designated time has been elapsed without any operation performed.

You can resume shooting by performing an operation, such as pressing the shutter button halfway down.

Note

- If you will not be using the camera for a long period of time, turn the camera off.

Power Save Start Time

You can set the time by which the power goes off automatically.

- 1 **MENU** →  (**Setup**) → **[Power Setting Option]** → **[Power Save Start Time]** → **desired setting.**

Menu item details

30 Min/5 Min/2 Min/1 Min

Note

- The power save function is deactivated in the following situations:
 - While power is being supplied via USB
 - While playing back slideshows
 - While recording movies
 - While connected to a computer or TV
 - When [Bluetooth Rmt Ctrl] is set to [On]
 - During USB Streaming

Power OFF w/ monitor

Sets whether or not the power turns off when the monitor is closed facing inward.

1 MENU →  (Setup) → [Power Setting Option] → [Power OFF w/ monitor] → desired setting.

Menu item details

Power OFF:

The power turns off when the monitor is closed facing inward.

Not Power OFF:

The power does not turn off when the monitor is closed facing inward.

Hint

- When you want to keep shooting images with the monitor closed facing inward, such as during interval shooting or movie recording, set [Power OFF w/ monitor] to [Not Power OFF].

Digital Camera
ZV-1M2

Auto Power OFF Temp.

Sets the temperature of the camera at which the camera turns off automatically during shooting. When it is set to [High], you can continue shooting even when the temperature of the camera gets hotter than normal.

1 MENU →  (Setup) → [Power Setting Option] → [Auto Power OFF Temp.] → desired setting.

Menu item details

Standard:

Sets the standard temperature for the camera to turn off.

High:

Sets the temperature at which the camera turns off to higher than [Standard].

Notes when [Auto Power OFF Temp.] is set to [High]

- Do not shoot while holding the camera in your hand. Use a tripod.
- Using the camera while holding it in your hand for a long period of time may cause low-temperature burns.

Continuous recording time for movies when [Auto Power OFF Temp.] is set to [High]

The duration of time available for continuous movie recording is as follows when the camera starts recording with the default settings after the power has been turned off for a while. The following values indicate the continuous time from when the camera starts recording until the camera stops recording.

Ambient temperature: 25°C (77°F)

Continuous recording time for movies (HD): Approx. 60 minutes

Continuous recording time for movies (4K): Approx. 60 minutes

Ambient temperature: 40°C (104°F)

Continuous recording time for movies (HD): Approx. 60 minutes

Continuous recording time for movies (4K): Approx. 30 minutes

HD: XAVC S HD (60p 50M/50p 50M; when the camera is not connected via Wi-Fi; when the monitor is open)

4K: XAVC S 4K (24p 60M/25p 60M; when the camera is not connected via Wi-Fi; when the monitor is open)

Note

- Even if [Auto Power OFF Temp.] is set to [High], depending on the conditions or the temperature of the camera, the recordable time for movies may not change.

Related Topic

- [Recordable movie times](#)

Digital Camera
ZV-1M2

USB Connection Mode

Selects the USB connection method when the camera is connected to a computer, etc.

① MENU →  (Setup) → [USB] → [USB Connection Mode] → desired setting.

Menu item details

Sel. When Connect:

Each time you connect the USB cable to the camera, select the mode you want to use from the following. ([Live Stream(USB Streaming)], [Image Transfer (MSC)], [Image Transfer (MTP)], or [Remote Shoot (PC Remote)])

USB Streaming:

Performs USB streaming via the connected computer or smartphone.

MassStorage(MSC):

Establishes a Mass Storage connection when connecting the camera to a computer, etc.

When you connect the camera to a computer or other USB device, the camera is recognized as a removable disk, and you can transfer files on the camera.

MTP:

Establishes an MTP connection between the camera, a computer, and other USB devices.

When you connect the camera to a computer or other USB device, the camera is recognized as a media device, and you can transfer still images/movies on the camera.

PC Remote:

Uses Imaging Edge Desktop (Remote) to control the product from a computer, including such functions as shooting and storing images on the computer.

Related Topic

- [Livestreaming video and audio \(USB Streaming\)](#)
- [Importing images to the computer](#)
- [Operating the camera from a computer](#)

Digital Camera
ZV-1M2

USB LUN Setting

Enhances compatibility by limiting of USB connection functions.

① **MENU** →  (Setup) → **[USB]** → **[USB LUN Setting]** → **desired setting.**

Menu item details

Multi:

Normally, use [Multi].

Single:

Set [USB LUN Setting] to [Single] only if you cannot make a connection.

Digital Camera
ZV-1M2

USB Power Supply

Sets whether to supply power via the USB cable when the product is connected to a computer or a USB device.

1 MENU →  (Setup) → [USB] → [USB Power Supply] → desired setting.

Menu item details

On:

Power is supplied to the product via a USB cable when the product is connected to a computer, etc.

Off:

Power is not supplied to the product via a USB cable when the product is connected to a computer, etc.

Operations available while supplying power via a USB cable

The following table shows you which operations are available/unavailable while supplying power via a USB cable.

Operation	Available / Unavailable
Shooting images	Available
Playing back images	Available
Wi-Fi/Bluetooth connections	Available
Charging a battery pack	Unavailable
Turning the camera on without a battery pack inserted	Unavailable



Note

- Insert the battery pack into the product to supply power via USB cable.
- The setting for [USB Power Supply] is effective only when this product is connected to a USB device that is compatible with the 500 mA power supply standard.

Digital Camera
ZV-1M2

HDMI Resolution

When you connect the camera to a TV or monitor device using an HDMI cable (sold separately), you can select the resolution to be output from the HDMI terminal of the camera during still image shooting or playback.

① MENU →  (Setup) → [External Output] → [ HDMI Resolution] → desired setting.

Menu item details

Auto:

The camera automatically recognizes the resolution of the connected TV or output device and sets the output resolution accordingly.

2160p/1080p:

Outputs signals in 2160p/1080p.

1080p:

Outputs signals in HD picture quality (1080p).

1080i:

Outputs signals in HD picture quality (1080i).

Note

- If images are not displayed properly using the [Auto] setting, select [1080i], [1080p], or [2160p/1080p] based on the connected TV.

Digital Camera
ZV-1M2

HDMI Output Settings (movie)

Sets the video and audio to be output to an external recorder/player connected via HDMI when shooting a movie. Use a Premium High Speed HDMI Cable (sold separately) to output 4K movies.

1 MENU →  (Setup) → [External Output] → [ HDMI Output Settings] → desired setting item.

Menu item details

Rec. Media dur HDMI Output:

Sets whether or not to record movies on the memory card of the camera during HDMI output.

[On]: Records movies on the memory card of the camera, and outputs the movies to the HDMI-connected device at the same time.

[Off(HDMI Only)]: Does not record movies on the memory card of the camera, and outputs movies only to devices connected via HDMI.

Output Resolution:

Sets the resolution of the image that will be output to another device connected via HDMI when [Rec. Media dur HDMI Output] is set to [On]. ([Auto]/[2160p/1080p]/[1080p]/[1080i])

4K Output Set.(HDMI Only):

Sets the frame rate and color depth of 4K movie output to another device connected via HDMI when [Rec. Media dur HDMI Output] is set to [Off(HDMI Only)]. ([30p 8bit]/[25p 8bit]/[24p 8bit])

Time Code Output:



Sets whether or not to output the time code and user bit to another device connected via HDMI. ([On] / [Off])

Time code information is transmitted as digital data, not as an image displayed on the screen. The connected device can then refer to the digital data in order to recognize the time data.

REC Control:

Sets whether to start or stop recording on the external recorder/player remotely by operating the camera when the camera is connected to an external recorder/player. ([On] / [Off])

Hint

- With [REC Control] set to [On],  STBY (STBY) is displayed when a recording command is ready to be sent to the external recorder/player, and  REC (REC) is displayed when a recording command is being sent to the external recorder/player.

Note

- A 4K movie is not output to the connected 4K-compatible device during slow-motion/quick-motion shooting.
- When [Rec. Media dur HDMI Output] is set to [Off(HDMI Only)], [HDMI Info. Display] becomes temporarily set to [Off].
- When [Rec. Media dur HDMI Output] is set to [Off(HDMI Only)], the counter does not move forward (the actual recording time is not counted) while the movie is being recorded on an external recorder/player.
- [REC Control] can be used with external recorders/players that support the [REC Control] function.
- When [Time Code Output] is set to [Off], you cannot set [REC Control].
- Even when  REC (REC) is displayed, the external recorder/player may not work properly depending on the settings or status of the recorder/player. Check if the external recorder/player works properly before use.
- When [Time Code Output] is set to [On], images may not be output properly to the TV or recording device. In this case, set [Time Code Output] to [Off].

- When shooting 4K movies with [Rec. Media dur HDMI Output] under [▶ HDMI Output Settings] set to [On], if a proxy movie is recorded at the same time, the movie cannot be output to a device connected via HDMI. To output movies using HDMI, set [Px Proxy Recording] to [Off]. (At this time, if [Rec Frame Rate] is set to anything other than [24p], the image will not be displayed on the camera monitor.)
- When [HDMI Info. Display] is set to [Off], images are displayed on both the HDMI-connected device and the camera monitor. However, when recording the following types of movies with [Rec. Media dur HDMI Output] set to [On], images are not displayed on the monitor of the camera.
 - XAVC S 4K 30p (when [Px Proxy Recording] is set to [Off])
 - XAVC S HD 120p
 - Slow-motion and quick-motion movies with [S&Q Frame Rate] set to [120fps]
- When [▶ File Format] is set to [XAVC S 4K] and an HDMI connection is used, the following functions are partially restricted.
 - Subject Recog in AF
 - Face Priority in Multi Metering

Digital Camera
ZV-1M2

HDMI Info. Display

Selects whether or not to display shooting information on a TV or a monitor device when the camera and TV, etc. are connected via an HDMI cable (sold separately).

1 MENU →  (Setup) → [External Output] → [HDMI Info. Display] → desired setting.

Menu item details

On:

Displays the shooting information on the TV.

The recorded image and shooting information are displayed on the TV, while nothing is displayed on the camera's monitor.

Off:

Does not display the shooting information on the TV.

Only the recorded image is displayed on the TV, while the recorded image and shooting information are displayed on the camera's monitor.

Note

- When [▶■ File Format] is set to [XAVC S 4K] during an HDMI connection, [Off] is applied.

Digital Camera
ZV-1M2

CTRL FOR HDMI

When connecting this product to a TV using an HDMI cable (sold separately), you can operate this product by aiming the TV remote control at the TV.

1 MENU →  (Setup) → [External Output] → [CTRL FOR HDMI] → desired setting.

2 Connect this product to a TV.

The input of the TV is switched automatically and images on this product are displayed on the TV screen.

- The operation method differs depending on the TV you are using. For details, refer to the operating instructions supplied with the TV.

Menu item details

On:

You can operate this product with a TV's remote control.

Off:

You cannot operate this product with a TV's remote control.

Note

- If you connect this product to a TV using an HDMI cable, available menu items are limited.
- If the product performs unwanted operations in response to the TV remote control, set [CTRL FOR HDMI] to [Off].

Digital Camera
ZV-1M2

Language

Selects the language to be used in the menu items, warnings and messages.

1 MENU →  (Setup) → [Area/Date] → [ Language] → desired language.

Digital Camera
ZV-1M2

Area/Date/Time Setting

You can set the area (where you are using the camera), daylight savings ([On]/[Off]), the date display format, and the date and time.

The Area/Date/Time setting screen will be displayed automatically if you did not register your smartphone in the initial setup or when the internal rechargeable backup battery has fully discharged. Select this menu to set the date and time after the first time.

1 MENU →  (Setup) → [Area/Date] → [Area/Date/Time Setting] → desired setting.

Menu item details

Area Setting:

Sets the area where you are using the camera.

Daylight Savings:

Selects Daylight Savings [On] / [Off].

Date/Time:

Sets the date and time.

- You can switch the time display format (24-hour or 12-hour format) by pressing the  (Delete) button.

Date Format:

Selects the date display format.

Hint

- To charge the internal rechargeable backup battery, insert a charged battery pack, and leave the product for 24 hours or more with the power off.
- If the clock resets every time the battery is charged, the internal rechargeable backup battery may be worn out. Consult your service facility.

Digital Camera
ZV-1M2

NTSC/PAL Selector

Plays back movies recorded with the product on a NTSC/PAL system TV.

① **MENU** →  (**Setup**) → **[Area/Date]** → **[NTSC/PAL Selector]** → **[Enter]**

Digital Camera
ZV-1M2

Audio signals

Selects whether the product produces a sound or not.

- 1 MENU →  (Setup) → [Sound Option] → [Audio signals] → desired setting.

Menu item details

On:all:

The shutter produces sounds, and sounds are produced for example when the focus is achieved by pressing the shutter button halfway down.

On:shutter only:

Only the shutter produces sounds. Sounds are not produced when focusing by pressing the shutter button halfway down, etc.

Off:

Sounds are not produced.

Hint

- When [ Silent Mode] is set to [On], [Audio signals] becomes locked to [Off].

Note

- If [ Focus Mode] is set to [Continuous AF], the camera will not beep when it focuses on a subject.

Related Topic

- [Silent Mode \(still image/movie\)](#)

Digital Camera
ZV-1M2

REC Lamp

Sets whether to turn on the recording lamps during movie recording.

1 MENU →  (Setup) → [Setup Option] → [REC Lamp] → desired setting.

Menu item details

On

The recording lamp lights up during recording.

Off

The recording lamp does not light up during recording.

Hint

- Set [REC Lamp] to [Off] if the light of the recording lamp reflected by an object, such as glass, is captured by the camera.

Version

Displays the version of this product's software. Check the version when updates for this product's software are released, etc.

① MENU →  (Setup) → [Setup Option] → [Version].

Hint

- You can also save the downloaded firmware data to a memory card and use the memory card to update the firmware of the camera.

Note

- Updating can be performed only when the battery level is  (3 remaining battery bars) or more. Use a sufficiently charged battery pack.

Digital Camera
ZV-1M2

Privacy Notice

Displays the privacy notification screen.

① **MENU** →  (**Setup**) → [**Setup Option**] → [**Privacy Notice**].

Digital Camera
ZV-1M2

Screen Reader (For some models only)

Sets the function for reading aloud information such as text on the screen.

Only some languages may be supported for this function depending on the model. This function is available only when the language set in the menu is supported by this function.

1 MENU →  (Setup) → [ Accessibility] → [Screen Reader] → desired setting item.

Menu item details

Screen Reader:

Sets whether to use the function to read aloud. ([On]/[Off])

Speed:

Sets the speed when reading aloud.

Volume:

Sets the volume when reading aloud.

Digital Camera
ZV-1M2

Setting Reset

Resets the product to the default settings. Even if you perform [Setting Reset], the recorded images are retained.

① MENU →  (Setup) → [Reset Settings] → [Setting Reset] → desired setting.

Menu item details

Camera Settings Reset:

Initializes the main shooting settings to the default settings. The setting values for both still image shooting and movie recording are initialized.

Initialize:

Initializes all the settings to the default settings.

Note

- Be sure not to eject the battery pack while resetting.
- If you perform [Initialize], the privacy policy agreement will also be initialized, so agree to the privacy policy again before using the camera.
- Settings of [ Picture Profile] will not be reset even when [Camera Settings Reset] or [Initialize] is performed.

Digital Camera
ZV-1M2

Functions available with a smartphone (Creators' App)

Using the smartphone application Creators' App, you can shoot an image while controlling the camera using a smartphone or transfer the images recorded on the camera to the smartphone.

Download and install the application Creators' App from your smartphone's application store. If Creators' App is already installed on your smartphone, be sure to update it to the latest version.

For details on Creators' App, refer to the following website.

<https://www.sony.net/ca/>

Hint

- You can also install Creators' App by scanning the QR Code displayed on the screen of the camera using your smartphone.

Note

- Depending on future version upgrades, the operational procedures or screen displays are subject to change without notice.

Supported smartphones

Refer to the support page for the latest information.

<https://www.sony.net/ca/help/mobile/>

- For details on Bluetooth versions compatible with your smartphone, check the product website for your smartphone.

Digital Camera
ZV-1M2

Pairing the camera with a smartphone (Smartphone Connection)







Connects the camera to your smartphone (pairing) to use the smartphone application Creators' App.

If you did not connect the camera with your smartphone when you turned on the camera for the first time, perform the following procedure.

The following is the procedure for connecting the camera to your smartphone when you install Creators' App on your smartphone for the first time.

: Operations performed on the smartphone

: Operations performed on the camera

- 1  : On the camera, select MENU →  (Network) → [ Cnct./PC Remote] → [Smartphone Connection].
- 2  : Follow the instructions on the screen and set [Bluetooth Function] to [On].
The pairing screen will appear.
 - If [Bluetooth Function] is already set to [On], the pairing screen will appear immediately.
- 3  : Launch Creators' App on your smartphone.
- 4  : Follow the instructions on the screen to pair the camera with your smartphone.
 - When the connection is completed, a menu to select a function for the camera appears on the smartphone.
- 5  : On the smartphone screen, select the desired function.

If you have used Creators' App with other cameras

Launch Creators' App after Step 2, open the [Cameras] screen, select the  (Add Camera) button, and follow the instructions on the screen to continue the operation.

About the icons when connecting to a smartphone

 (Bluetooth connection available): Bluetooth connection with the smartphone is established.



 (Bluetooth connection unavailable): Bluetooth connection with the smartphone is not established.

 (Wi-Fi connection available): Wi-Fi connection with the smartphone is established.

 (Wi-Fi connection unavailable): Wi-Fi connection with the smartphone is not established.

Connecting the camera and smartphone without pairing

If you want to connect without pairing, you need to perform the Wi-Fi connection operation every time.

1. On the camera, select MENU →  (Network) → [ Cnct./PC Remote] → [Smartphone Connection].
2. Select [Connect a smartphone].
3. Press the  (Delete) button on the camera to switch to the SSID and password screen.

4. Launch Creators' App on your smartphone and open the [Cameras] screen.
5. Select the  (Setup) button in the upper right corner of the [Cameras] screen, and then select [Connect only via Wi-Fi].
6. Follow the instructions on the screen and open the Wi-Fi setting screen on your smartphone.
7. On the Wi-Fi setting screen on your smartphone, select the SSID displayed on the camera and enter the password.
8. Switch the screen back to Creators' App on your smartphone and select the product name of the camera (ZV-1M2).
The smartphone will connect to the camera.

Note

- [Smartphone Connection] cannot be executed when [Airplane Mode] is set to [On].
- Up to 2 devices can be connected to the camera at the same time using Bluetooth communication.
- Radio wave interference may occur as Bluetooth communications and Wi-Fi (2.4 GHz) communications use the same frequency band. If your Wi-Fi connection is unstable, it may be improved by turning off the Bluetooth function of the smartphone.
- The Bluetooth icon is not displayed when the touch function icons are displayed in the movie recording mode. To see the Bluetooth icon, swipe the touch function icons left or right to hide the touch function icons.

Related Topic

- [Functions available with a smartphone \(Creators' App\)](#)
- [Using a smartphone as a remote commander](#)
- [Select on Cam & Send \(transferring to a smartphone\)](#)
- [Cnct. while Power OFF \(smartphone\)](#)
- [Reading location information from a smartphone](#)

Using a smartphone as a remote commander

With Creators' App, you can shoot images while checking the shooting range of the camera on the screen of the smartphone. Connect the camera and smartphone by referring to "Related Topic" at the bottom of this page. For details on functions that can be operated from a smartphone, refer to the following support page.

<https://www.sony.net/ca/help/opr/>

Related Topic

- [Pairing the camera with a smartphone \(Smartphone Connection\)](#)
- [Remote Shoot Setting](#)

Remote Shoot Setting

Configures settings for images saved when performing remote shooting using a smartphone or computer.

① **MENU** →  (**Network**) → [ **Cnct./PC Remote**] → [**Remote Shoot Setting**] → **desired setting item.**

Menu item details

Still Img. Save Dest.:

Sets whether or not to save still images to both the camera and the smartphone or the computer during remote shooting. ([Destination Only]/[Dest.+Camera]/[Camera Only])

Save Image Size:

Selects the file size for images to be transferred to the smartphone or the computer when [Still Img. Save Dest.] is set to [Dest.+Camera]. The original-sized JPEG file or a 2M-equivalent JPEG file can be transferred. ([Original]/[2M])

RAW+J Save Image:

Selects the file type for images to be transferred to the smartphone or the computer when [Still Img. Save Dest.] is set to [Dest.+Camera]. ([RAW & JPEG]/[JPEG Only]/[RAW Only])

Note

- When an unrecordable memory card is inserted into the camera, you cannot record still images even if [Still Img. Save Dest.] is set to [Camera Only] or [Dest.+Camera].
- When [Camera Only] or [Dest.+Camera] is selected for [Still Img. Save Dest.] and no memory card is inserted into the camera, the shutter will not be released even if [Release w/o Card] is set to [Enable].
- While a still image is being played back on the camera, you cannot perform remote shooting using a smartphone or a computer.
- [RAW+J Save Image] can be set only when [ File Format] is set to [RAW & JPEG].

Related Topic

- [Using a smartphone as a remote commander](#)











Digital Camera
ZV-1M2

Select on Cam & Send (transferring to a smartphone)

You can transfer images to a smartphone by selecting images on the camera.



Refer to “[Pairing the camera with a smartphone \(Smartphone Connection\)](#)” to pair the camera and smartphone in advance.

The following is the procedure for transferring the image currently displayed on the camera.

- 1 **MENU** →  (Network) → [ Cnct./PC Remote] → [ Select on Cam & Send] → [Size of Sending Image], [RAW+J Trans. Trgt.], [ Px Sending Target] → desired setting.
- 2 **Display the image to be transferred on the playback screen.**
- 3 **MENU** →  (Network) → [ Cnct./PC Remote] → [ Select on Cam & Send] → [ Send] → [This Image].
 - You can also display the [ Send] screen by pressing the  (Send to Smartphone) button.
- 4 **Launch Creators' App on your smartphone.**

A message indicating that the transfer has started will appear.
- 5 **Select [OK] on the smartphone.**

The image will be transferred to the smartphone.

 - When the image is transferred, the  (transferred) icon will appear on the screen of the camera.
 - You can transfer multiple images at once by selecting a setting other than [This Image] under [ Send].

Menu item details

Send:

Selects images and transfers them to a smartphone. ([This Image]/[All Images in This Group]/[All with this date]/[Filtered Images]/[Multiple Images])

- The options displayed may differ depending on the View Mode selected on the camera.
- If you select [Multiple Images], select the desired images using the center of the control wheel, then press MENU → [Enter].

Size of Sending Image:

Selects the file size for images to be transferred to the smartphone. The original-sized JPEG file or a 2M-equivalent JPEG file can be transferred. ([Original]/[2M])

RAW+J Trans. Trgt.:

Selects the file type for images to be transferred to a smartphone when the images are shot with [ File Format] set to [RAW & JPEG]. ([JPEG Only]/[RAW]/[RAW & JPEG])

Sending Target:

Sets whether to transfer the low-bit-rate proxy movie or the high-bit-rate original movie when transferring a movie to a smartphone. ([Proxy Only]/[Original Only]/[Proxy & Original])

When you select [Proxy Only], movies can be transferred faster than when transferring the original movies.

Movie with Shot Mark:

Cuts and transfers a specified number of seconds from a movie with the position of a Shot Mark set as the center. ([Cut to 60 seconds]/[Cut to 30 seconds]/[Cut to 15 seconds]/[Don't Cut])

To filter the images to be transferred (Filtered Images)

Images to be transferred can be filtered by the following conditions:

- Target Group: [This Date]/[This Media]
- Still Images/Movies: [All]/[Only Still Images]/[Only Movies]
- Target Img (Rating): [★]-[★★], [★OFF]
- Target Movie (**S**): [All]/[Only Shot Mark Mov.]
- Target Img (Protect): [All]/[Only Protected Img.]
- Transfer Status * : [All]/[Only Non-transfer]



* Images transferred by selecting them on the smartphone are treated as not yet transferred.

* When [Movie with Shot Mark] is set to an item other than [Don't Cut], even if you have already transferred a clip by using a Shot Mark and then set another Shot Mark to the movie, all of the Shot Marks will create clips which will be retransferred as not-yet transferred images.

To add a Shot Mark to a movie

If you add a Shot Mark while recording a movie, you can use it as a mark for selecting, transferring, or editing the movie. To add a Shot Mark during recording, swipe left or right on the screen to display the touch function icons, and then touch **S1** (Add Shot Mark1). You can also add a Shot Mark during playback by touching **S1** (Add Shot Mark1) on the screen.

Hint

- To use the touch function icons, enable touch operations during shooting or playback by configuring each setting in MENU →  (Setup) → [Touch Operation].
- Use a custom key to add a second Shot Mark (Shot Mark 2). Shot Mark 1 can also be added using a custom key. Assign the following functions to the desired keys and press the keys while shooting or playing back a movie.
 - When adding a Shot Mark while shooting a movie: assign [Add Shot Mark1] / [Add Shot Mark2] in [ Custom Key Setting]
 - When adding a Shot Mark while playing back a movie: assign [Add/Delete Shot Mark1]/[Add/Delete Shot Mark2] in [ Custom Key Setting]
- For movies with a Shot Mark, you can jump to the position with the Shot Mark by touching the touch function icon while paused.

Note

- For images transferred by selecting them on the smartphone, the  (transferred) icon will not appear.
- Depending on the smartphone, the transferred movie may not be played back correctly. For example, the movie may not play smoothly, or there may be no sound.
- Depending on the format of the still image, movie, slow-motion movie, or quick-motion movie, it may not be possible to play it back on a smartphone.
- When [Airplane Mode] is set to [On], you cannot connect this product and the smartphone. Set [Airplane Mode] to [Off].

Related Topic

- [Pairing the camera with a smartphone \(Smartphone Connection\)](#)
- [Airplane Mode](#)

Digital Camera
ZV-1M2

Reset Transfer Status (transferring to a smartphone)

You can reset the transfer status of images that have been transferred to your smartphone. Use this function if you want to retransfer images that have previously been transferred. The transferred images will not be deleted even if you reset the transfer status.

1 MENU →  (Network) → [ Cnct./PC Remote] → [ Reset Transfer Status].

- If you press [OK] on the confirmation screen, all images that have been transferred to your smartphone will become untransferred images.

Related Topic

- [Select on Cam & Send \(transferring to a smartphone\)](#)

Cnct. while Power OFF (smartphone)

Sets whether or not to accept Bluetooth connections from a smartphone while the camera is turned off. When [Cnct. while Power OFF] is set to [On], you can browse images on the camera's memory card and transfer images from the camera to a smartphone by operating the smartphone.

1 MENU →  (Network) → [Cnct./PC Remote] → [Cnct. while Power OFF] → desired setting.

Menu Item Details

On :
Accepts Bluetooth connections from a smartphone while the camera is turned off.
The battery level is depleted gradually while the camera is turned off. If you do not want to use [Cnct. while Power OFF], turn it off.

Off :
Does not accept Bluetooth connections from a smartphone while the camera is turned off.

How to browse/transfer images on the smartphone

Refer to "[Pairing the camera with a smartphone \(Smartphone Connection\)](#)" to pair the camera and smartphone in advance.

1. Set [Cnct. while Power OFF] to [On].
2. Turn off the camera.
3. Launch Creators' App on the smartphone.
4. Select [View and Import] on the smartphone.
 - The images saved on the memory card of the camera can be viewed and are ready to be transferred.

Note

- If the smartphone is not operated for a certain period of time, the Bluetooth connection will become deactivated. Select [View and Import] again on the smartphone.
- When the camera is turned on, the camera will switch to the shooting screen, and the connection with the smartphone will be terminated.
- [Cnct. while Power OFF] will be set to [Off] if you cancel pairing between the camera and the smartphone or pairing fails.
- If the function does not work properly, check the following notes and then try pairing again.
 - Ensure that the camera is either not connected to any other device or connected to only one device using Bluetooth communication. (Up to 2 devices can be connected to the camera at the same time.)
 - Confirm that [Airplane Mode] for the camera is set to [Off].
 - If the function does not work properly even after you have performed the above operations, delete the pairing information for the device that you want to connect using [Manage Paired Device] on the camera.

Related Topic

- [Functions available with a smartphone \(Creators' App\)](#)
- [Pairing the camera with a smartphone \(Smartphone Connection\)](#)

- [Select on Cam & Send \(transferring to a smartphone\)](#)
- [Bluetooth Settings](#)

5-049-603-11(1) Copyright 2023 Sony Corporation

Reading location information from a smartphone

You can use the application Creators' App to obtain location information from a smartphone that is connected with your camera using Bluetooth communication. You can record the obtained location information when shooting images. Refer to “[Pairing the camera with a smartphone \(Smartphone Connection\)](#)” to pair the camera and smartphone in advance.

- 1 **Launch Creators' App on your smartphone, open the [Cameras] screen, and tap [Setup] → [Location Information Linkage].**
- 2 **Activate [Location Information Linkage] on the [Location Information Linkage] setting screen of Creators' App.**
 -  (obtaining location information icon) will be displayed on the monitor of the camera. Location information obtained by your smartphone using GPS, etc., will be recorded when shooting images.
 - When you activate [Auto Time Correction] or [Auto Area Adjustment] on a linked smartphone, the camera automatically corrects the date setting or area setting using information from the smartphone.

Icons displayed when obtaining the location information

 (Obtaining location information): The camera is obtaining the location information.

 (Location information cannot be obtained): The camera cannot obtain the location information.

Hint

- Location information can be linked when Creators' App is running on your smartphone even if the smartphone monitor is off. However, if the camera has been turned off for a while, location information may not be linked immediately when you turn the camera back on. In this case, location information will be linked immediately if you open the Creators' App screen on the smartphone.
- When Creators' App is not operating, such as when the smartphone is restarted, launch Creators' App to resume location information linking.
- If the location information linking function does not work properly, see the following notes and perform pairing again.
 - Confirm that the Bluetooth function of your smartphone is activated.
 - Ensure that the camera is either not connected to any other device or connected to only one device using Bluetooth communication. (Up to 2 devices can be connected to the camera at the same time.)
 - Confirm that [Airplane Mode] for the camera is set to [Off].
 - Delete the pairing information for the camera registered in Creators' App.
 - Delete the pairing information for the camera registered in the Bluetooth settings on your smartphone.
 - Delete the pairing information for your smartphone registered in [Manage Paired Device] on the camera.
- The Bluetooth icon is not displayed when the touch function icons are displayed in the movie recording mode. To see the Bluetooth icon, swipe the touch function icons left or right to hide the touch function icons.

Note

- When you initialize the camera, the pairing information is also deleted. Before performing pairing again, first delete the pairing information for the camera registered in the smartphone's Bluetooth settings and Creators' App.
- The location information will not be recorded when it cannot be obtained, such as when the Bluetooth connection is disconnected.

- The camera can be paired with up to 15 Bluetooth devices, but can link the location information with that of only one smartphone. If you want to link the location information with that of another smartphone, turn off the [Location Information Linkage] function under [Setup] in Creators' App on the smartphone that is already linked.
- If the Bluetooth connection is unstable, remove any obstacles, such as people or metal objects from between the camera and the paired smartphone.
- The communication distance for the Bluetooth connection or Wi-Fi may vary depending on the conditions of use.

Related Topic

- [Functions available with a smartphone \(Creators' App\)](#)
- [Pairing the camera with a smartphone \(Smartphone Connection\)](#)
- [Bluetooth Settings](#)

5-049-603-11(1) Copyright 2023 Sony Corporation

Digital Camera
ZV-1M2

Recommended computer environment

You can confirm the operating computer environment of the software from the following URL:

<https://www.sony.net/pcenv/>

Connecting the camera to a computer

- 1 Insert a sufficiently charged battery pack into the camera.
- 2 Turn on the camera and the computer.
- 3  (Setup) → [USB] → Set [USB Connection Mode] to [MassStorage(MSC)].
- 4 **Connect the USB Type-C terminal on the camera to the computer with a commercially available USB cable.**
 - When you connect the camera to the computer for the first time, the procedure for recognizing the camera may start automatically on the computer. Wait until the procedure is finished.
 - If you connect the camera to your computer using the USB cable when [USB Power Supply] is set to [On], power is supplied from your computer. (Default setting: [On])
 - Use a cable that complies with the USB standard.

Note

- Do not turn on/off or restart the computer, or wake the computer from sleep mode when a USB connection has been established between the computer and the camera. Doing so may cause a malfunction. Before turning on/off or restarting the computer, or waking the computer from sleep mode, disconnect the camera from the computer.

Related Topic

- [USB Connection Mode](#)
- [USB LUN Setting](#)

Disconnecting the camera from the computer

Perform the following operations on the computer before disconnecting the camera from the computer.

1 Click  (Safely Remove Hardware and Eject Media) in the taskbar.

2 Click the displayed message.

The following operations are available after you have completed the steps above.

- Disconnecting the USB cable.
- Removing a memory card.
- Turning off the camera.

Note

- On Mac computers, drag and drop the memory card icon or the drive icon into the “Trash” icon. The camera will be disconnected from the computer.
- On some computers, the disconnection icon may not appear. In this case, you can skip the steps above.
- Do not remove the USB cable from the camera while the access lamp is lit. The data may be damaged.

Introduction to computer software (Imaging Edge Desktop/Catalyst)

Imaging Edge Desktop

Imaging Edge Desktop is a software suite that includes functions such as remote shooting from a computer, and adjusting or developing RAW images recorded with the camera.

For details on how to use Imaging Edge Desktop, refer to the support page.

<https://www.sony.net/disoft/help/>

Installing Imaging Edge Desktop on your computer

Download and install the software by accessing the following URL:

<https://www.sony.net/disoft/d/>

Catalyst Browse (free software)/Catalyst Prepare (paid software)

Catalyst Browse is software for previewing clips. You can preview recorded XAVC S clips, view and edit media metadata, apply image stabilization* using metadata, apply color calibration, copy to the local hard drive, or transcode to a variety of formats and so on with Catalyst Browse.

Catalyst Prepare adds to the functions of Catalyst Browse allowing you to organize clips using bins, perform basic timeline editing with storyboards, and so on.

* For the conditions of use of the image stabilization function, refer to the support page.

Installing Catalyst Browse/Catalyst Prepare on your computer

Download and install the software by accessing the following URL:

<https://www.sony.net/disoft/>

Importing images to the computer

You can import images from the camera to a computer by connecting the camera to the computer with a commercially available USB cable, or by inserting the memory card of the camera into the computer.

Open the folder in which the images you want to import are stored on the computer, and then copy the images to the computer.

Example: Folder tree during USB Mass Storage connection

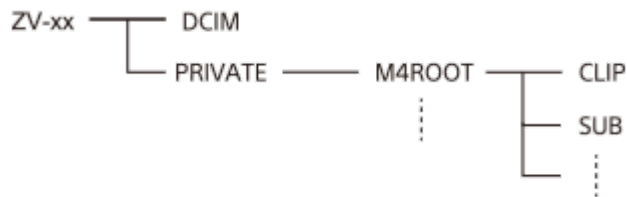

DCIM: still images

CLIP: movies

SUB: proxy movies

Note

- Do not edit or otherwise process movie files/folders from the connected computer. Movie files may be damaged or become unplayable. Do not delete movies on the memory card from the computer. Sony is not held liable for consequences resulting from such operations via the computer.
- If you delete images or perform other operations from the connected computer, the image database file may become inconsistent. In this case, repair the image database file.
- The folder tree is different during MTP connection.

Operating the camera from a computer

With a USB connection, you can control the camera from a computer, including such functions as shooting and storing images on the computer.

When the camera and a smartphone are connected, you cannot control the camera from a computer. Make sure that the camera is not connected to a smartphone beforehand.

1 Connect the camera to the computer.

- Connect the USB Type-C terminal on the camera to the computer with a USB cable.

2 Launch Imaging Edge Desktop (Remote) on the computer.

You can now operate the camera using Imaging Edge Desktop (Remote).

Hint

- In [Remote Shoot Setting] under [ Cnct./PC Remote], you can set the save destination and saved format of still images for PC remote shooting.

Related Topic

- [Introduction to computer software \(Imaging Edge Desktop/Catalyst\)](#)
- [Remote Shoot Setting](#)

Digital Camera
ZV-1M2

Remote Shoot Setting

Configures settings for images saved when performing remote shooting using a smartphone or computer.

1 MENU →  (Network) → [ Cnct./PC Remote] → [Remote Shoot Setting] → desired setting item.

Menu item details

Still Img. Save Dest.:

Sets whether or not to save still images to both the camera and the smartphone or the computer during remote shooting. ([Destination Only]/[Dest.+Camera]/[Camera Only])

Save Image Size:

Selects the file size for images to be transferred to the smartphone or the computer when [Still Img. Save Dest.] is set to [Dest.+Camera]. The original-sized JPEG file or a 2M-equivalent JPEG file can be transferred. ([Original]/[2M])

RAW+J Save Image:

Selects the file type for images to be transferred to the smartphone or the computer when [Still Img. Save Dest.] is set to [Dest.+Camera]. ([RAW & JPEG]/[JPEG Only]/[RAW Only])

Note

- When an unrecordable memory card is inserted into the camera, you cannot record still images even if [Still Img. Save Dest.] is set to [Camera Only] or [Dest.+Camera].
- When [Camera Only] or [Dest.+Camera] is selected for [Still Img. Save Dest.] and no memory card is inserted into the camera, the shutter will not be released even if [Release w/o Card] is set to [Enable].
- While a still image is being played back on the camera, you cannot perform remote shooting using a smartphone or a computer.
- [RAW+J Save Image] can be set only when [ File Format] is set to [RAW & JPEG].

Related Topic

- [Using a smartphone as a remote commander](#)

Livestreaming video and audio (USB Streaming)



You can connect a computer, etc. to the camera and use the camera video and audio for livestreaming or web-conferencing services. Select MENU →  (Setup) → [USB] → [USB Connection Mode] → [Sel. When Connect] or [USB Streaming] beforehand.

1 Connect the camera to a computer or other device with a commercially available USB cable.

[USB Streaming:Standby] will appear on the camera screen, and the camera will switch to the streaming standby state.



- If [USB Connection Mode] is set to [Sel. When Connect], select [Live Stream(USB Streaming)] on the selection screen for the USB connection mode.
- Use a cable or adapter that matches the terminal on the device to be connected.

2 Start streaming from your livestreaming/web-conferencing service.

[USB Streaming:Output] will appear on the camera screen.



- To exit [USB Streaming], turn off the power of the camera or disconnect the USB cable.

Hint

- If you assign [Product Showcase Set] or [Background Defocus] to [ Custom Key Setting], you can use these functions even during USB streaming.
- The format of the streaming data is as follows.
 - Video format: MJPEG
 - Resolution: HD720 (1280×720)
 - Frame rate: 30 fps / 25 fps
 - Audio format: LPCM, 48 kHz, 16 bit, 2 ch
- During USB streaming, power is supplied to the camera from the computer. If you want to consume as little computer power as possible, set [USB Power Supply] to [Off].
- When using an external microphone, you can minimize deviations between your voice and the movements of your mouth by connecting the microphone to the  (microphone) terminal of the camera.

Note

- While USB streaming is in progress, the camera is always set to the movie recording mode regardless of the shooting mode before the start of streaming.
- You cannot do the following while [USB Streaming] is running.
 - Transition to the playback screen
 - Network functions (PC remote, remote operation from a smartphone, etc.)
- The following functions are disabled while [USB Streaming] is running.
 - Recording the streaming video
 - Menu-screen operations

- Capturing a custom white balance
-  Picture Profile
- Power Save Start Time
-  Auto Monitor OFF



Related Topic

- [USB Connection Mode](#)

5-049-603-11(1) Copyright 2023 Sony Corporation

Battery life and number of recordable images

Number of images when shooting still images

[ Auto Monitor OFF] is set to [Does not turn OFF]	Approx. 290 images
[ Auto Monitor OFF] is set to [2 Sec]	Approx. 440 images

Battery life when shooting movies

Actual shooting of movies	Approx. 45 min.
Continuous shooting of movies	Approx. 75 min.

- The above estimates for battery life and number of recordable images apply when the battery pack has been fully charged. The battery life and number of images may decrease depending on the conditions of use.
- The battery life and number of recordable images are estimates based on shooting with the default settings under the following conditions:
 - Using the battery pack at an ambient temperature of 25°C (77°F).
 - Using a Sony SDXC memory card (U3) (sold separately)
- The numbers of recordable still images are based on the CIPA standard and shooting under the following conditions: (CIPA: Camera & Imaging Products Association)
 - One picture is taken every 30 seconds.
 - The power is turned on and off once every ten times.
 - The zoom is switched alternately between the W and T ends.
- The number of minutes for movie shooting is based on the CIPA standard and shooting under the following conditions:
 - The image quality is set to XAVC S HD 60p 50M /50p 50M 4:2:0 8bit.
 - Actual shooting (movies): Battery life based on repeated shooting, zooming, shooting stand-by, turning on/off, etc.
 - Continuous shooting (movies): No operations other than starting and ending shooting are performed.

Digital Camera
ZV-1M2

Number of recordable images

When you insert a memory card into the camera and turn the camera on, the number of images that can be recorded (should you continue to shoot using the current settings) is displayed on the screen.

Note

- When "0" (the number of recordable images) flashes in orange, the memory card is full. Replace the memory card with another one, or delete images from the current memory card.
- When "NO CARD" flashes in orange, it means no memory card has been inserted. Insert a memory card.

The number of images that can be recorded on a memory card

The table below shows the approximate number of images that can be recorded on a memory card formatted with this camera.

The numbers shown reflect the following conditions:

- Using a Sony memory card
- [Aspect Ratio] is set to [3:2], and [JPEG Image Size] is set to [L: 20M]. ^{*1}

The values may vary depending on the shooting conditions and the type of memory card used.

(Unit: images)

JPEG Quality /  File Format	SD memory card	
	64GB	128GB
Standard	9 500	19 000
Fine	5 500	11 000
Extra fine	4 100	8 200
RAW & JPEG ^{*2}	1 600	3 300
RAW	2 300	4 700

*1 When [Aspect Ratio] is set to other than [3:2], you can record more images than the numbers shown in the table above. (except when [RAW] is selected)

*2 JPEG image quality when [RAW & JPEG] is selected: [Fine]

Note

- Even if the number of recordable images is higher than 9 999 images, "9999" will appear.

Related Topic

- [Memory cards that can be used](#)

Recordable movie times

The table below shows the approximate total recording times using a memory card formatted with this camera. The values may vary depending on the shooting conditions and the type of memory card used.

(h (hour), min (minute))

File Format	Rec Frame Rate	Record Setting	SD memory card	
			64 GB	128 GB
XAVC S 4K	30p/25p	100M	1 h 10 min	2 h 20 min
		60M	1 h 50 min	4 h
XAVC S HD	60p/50p	50M	2 h 10 min	4 h 30 min
		25M	3 h 50 min	7 h 50 min

The recording times when [**Px** Proxy Recording] is set to [Off].

- The times shown are recordable times using a Sony memory card.
- The duration of time available for movie recording varies depending on the file format/recording settings for movies, memory card, ambient temperature, Wi-Fi network environment, condition of the camera before you start recording, and condition of the charging of the battery.
The maximum continuous recording time for a single movie shooting session is approximately 13 hours (a product specification limit).

Note

- The recordable time of movies varies because the camera is equipped with VBR (Variable Bit-Rate), which automatically adjusts image quality depending on the shooting scene. When you record a fast-moving subject, the image is clearer but the recordable time is shorter because more memory is required for recording. The recordable time also varies depending on the shooting conditions, the subject or the image quality/size settings.

Notes on continuous movie recording

- High-quality movie recording and high-speed continuous shooting require large amounts of power. Therefore, if you continue to shoot, the temperature inside the camera will rise, especially that of the image sensor. In such cases, the camera will turn off automatically because the surface of the camera is heated to a high temperature or the high temperature affects the quality of the images or the internal mechanism of the camera.
- The duration of time available for continuous movie recording when the camera records with the default settings after the power has been turned off for a while is as follows. The values indicate the continuous time from when the camera starts recording until the camera stops recording.

When [Auto Power OFF Temp.] is set to [Standard]

File Format	XAVC S HD	XAVC S 4K
Ambient temperature: 25°C (77°F)	Approx. 60 minutes	Approx. 20 minutes

▶ File Format	XAVC S HD	XAVC S 4K
Ambient temperature: 40°C (104°F)	Approx. 30 minutes	Approx. 20 minutes

When [Auto Power OFF Temp.] is set to [High]

▶ File Format	XAVC S HD	XAVC S 4K
Ambient temperature: 25°C (77°F)	Approx. 60 minutes	Approx. 60 minutes
Ambient temperature: 40°C (104°F)	Approx. 60 minutes	Approx. 30 minutes

XAVC S HD: 60p 50M/50p 50M; when the camera is not connected via Wi-Fi; when the monitor is open

XAVC S 4K: 24p 60M/25p 60M; when the camera is not connected via Wi-Fi; when the monitor is open

- The duration of time available for movie recording varies with the temperature, file format/record setting for movies, Wi-Fi network environment, or condition of the camera before you start recording. If you frequently recompose or shoot images after the power is turned on, the temperature inside the camera will rise and the recording time available will be shorter.
- If the  (Overheating warning) icon appears, the temperature of the camera has risen.
- If the camera stops movie recording due to a high temperature, leave it for some time with the power turned off. Start recording after the temperature inside the camera drops fully.
- If you observe the following points, you will be able to record movies for longer periods of time.
 - Keep the camera out of direct sunlight.
 - Turn the camera off when it is not being used.

Related Topic

- [Memory cards that can be used](#)
- [Battery life and number of recordable images](#)

List of icons on the screen for shooting movies

The displayed contents and their positions in the illustrations are just guidelines, and may differ from the actual displays. Descriptions are given below the indications of the icons.



In addition to the icons described on this page, there are more icons for touch operations (touch function icons) that are displayed on the left or right side of the screen when you swipe the monitor. For details, refer to “[Touch function icons.](#)”

1. Basic camera settings



Audio level



Audio recording off



Microphone Directivity



Focus Mode



Clear Image Zoom/Digital Zoom



Gamma Disp. Assist Typ.

STBY REC

Movie recording standby/Movie recording in progress

1:00:12

Actual movie recording time (hours: minutes: seconds)

4K HD

File format of movies

120p 100p 60p 50p 30p 25p 24p

Frame rate of movies



Memory card status

1h 30m

Recordable time of movies



Writing data / Number of images left to write



Remaining battery



Remaining battery warning



USB power supply

2. Exposure and other settings

1/250

Shutter speed

F3.5

Aperture value



Exposure compensation/Metered Manual

ISO400 **ISO 400**

ISO sensitivity

AWB **AWB** **AWB** **7500K A5 G5**

White Balance (Auto, Preset, Underwater Auto, Custom, Color temperature, Color filter)



AE lock/AWB lock



ND filter in action

3. Other settings (displayed during recording standby)

i **P** **A** **S** **M** **i** **S&Q** **S&Q** **P** **S&Q** **A** **S&Q** **S** **S&Q** **M**

Shooting mode

MR1 **M** **S&Q** **M2** **S**

Shooting mode (**MR** Cam.Set)

REC **STBY**

REC Control

EXT 4K **EXT 4K**

4K external output

00:00:00.00

Time code (hours: minutes: seconds. frames)

00 00 00 00

User Bit

Spot Focus

Performing [Spot Focus]

x4 Slow x4 Quick

Slowness/quickness scale during slow-motion/quick-motion shooting

10s

Movie self-timer

USB
STRM

USB streaming

HD(720p) 30p

USB streaming output format

USB Streaming : Standby / USB Streaming : Output

USB streaming status

Select Focus Point On/Off

Guide display for setting Focus Area

Tracking Cancel

Guide display for tracking

Focus Cancel

Guide display for canceling focusing

Tracking+AE Cancel

Guide display for tracking+AE

Focus+AE Cancel

Guide display for focus+AE

● Touch AE Cancel

Guide display for touch AE

▼ Switch Av/Tv

Guide display for switching aperture value and shutter speed



Focus Cancel



Touch Focus+AE cancel/TouchTracking+AE cancel/Touch AE cancel



Tracking Cancel



PC remote



Airplane Mode



Connected to Wi-Fi/Disconnected from Wi-Fi



Bluetooth connection available / Bluetooth connection unavailable



Remote control



Obtaining location information / Location information cannot be obtained



Metering Mode



D-Range Optimizer



Creative Look



Focus Area

C:32:00

Self-diagnosis display



Histogram

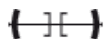

Digital level gauge



Overheating warning



Database file full / Database file error

Hint

- Area 3 icons may not be displayed while the touch function icons are displayed. To see hidden icons, swipe the touch function icons left or right to hide the touch function icons.

Related Topic

- [List of icons on the screen for shooting still images](#)
- [List of icons on the playback screen](#)

List of icons on the screen for shooting still images

The displayed contents and their positions in the illustrations are just guidelines, and may differ from the actual displays. Descriptions are given below the indications of the icons.

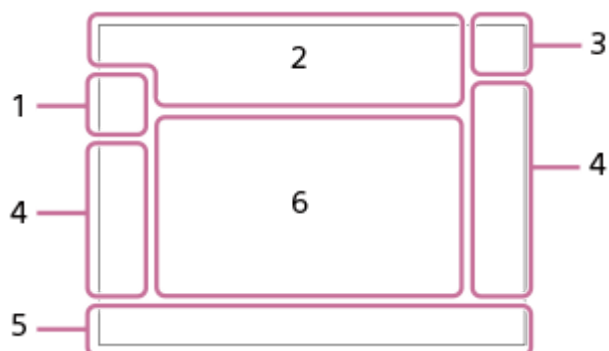

In addition to the icons described on this page, there are more icons for touch operations (touch function icons) that are displayed on the left or right side of the screen when you swipe the monitor. For details, refer to “[Touch function icons.](#)”

1. Shooting mode

i **P** **P*** **A** **S** **M**
Shooting mode

📷 **📷** **📷** **📷** **📷** **📷** **📷**
Shooting mode (Scene Selection)

M
Shooting mode (**MR** Cam.Set)

🚶
Scene Recognition icon (Move)

2. Camera settings

NO CARD
Memory card status

100
Remaining number of recordable images

|||||3
Writing data / Number of images left to write

20M / 18M / 17M / 13M / 10M / 7.5M / 6.5M / 5M / 4.2M / 3.7M
Image size of still images

RAW
RAW recording

J-X.FINE J-FINE J-STD
JPEG Quality

AF-S AF-A AF-C DMF MF
Focus Mode

⚡
Flash charge in progress

VIEW
Setting Effect OFF

S **C** **D**
Smart Zoom/Clear Image Zoom/Digital Zoom

-PC-

PC remote



Bright Monitoring



Silent mode



Remote control



Connected to Wi-Fi/Disconnected from Wi-Fi



Focus Cancel



Touch Focus+AE cancel/TouchTracking+AE cancel/Touch AE cancel



Tracking Cancel



Bluetooth connection available / Bluetooth connection unavailable



Obtaining location information / Location information cannot be obtained



Airplane Mode



Overheating warning



Database file full / Database file error

3. Battery



Remaining battery



Remaining battery warning



USB power supply

4. Shooting settings



Drive Mode



Flash Mode

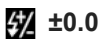

Flash Comp.



Focus Mode



Focus Area



Metering Mode



White Balance (Auto, Preset, Underwater Auto, Custom, Color temperature, Color filter)



D-Range Optimizer



Creative Look



 Subject Recog in AF/  Recognition Target

PP1 - **PP10** 

 Picture Profile

5. Focus indicator/exposure settings



Focus indicator

1/250

Shutter speed

F3.5

Aperture value



Background Defocus



Exposure compensation/Metered Manual

ISO400 ISO AUTO

ISO sensitivity



AE lock/AWB lock



ND filter in action

6. Guides/other

 **Select Focus Point On/Off**

Guide display for setting Focus Area

 **Tracking Cancel**

Guide display for tracking

 **Focus Cancel**

Guide display for canceling focusing

 **Tracking+AE Cancel**

Guide display for tracking+AE

 **Focus+AE Cancel**

Guide display for focus+AE

 **Touch AE Cancel**

Guide display for touch AE

 **Switch Av/Tv**

Guide display for switching aperture value and shutter speed



Bracket indicator

C:32:00

Self-diagnosis display



Spot metering area



Histogram

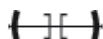

Digital level gauge

Related Topic

- [List of icons on the screen for shooting movies](#)
- [List of icons on the playback screen](#)

List of icons on the playback screen

The displayed contents and their positions in the illustrations are just guidelines, and may differ from the actual displays. Descriptions are given below the indications of the icons.

Single-image playback

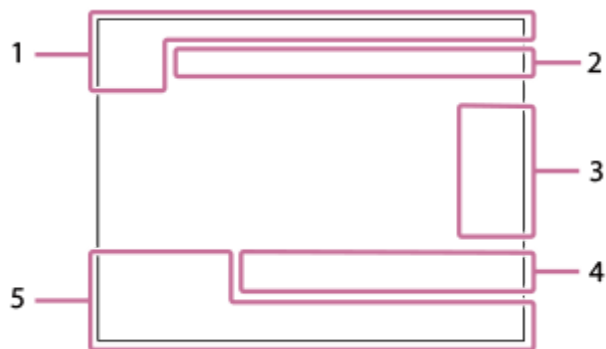

Histogram display

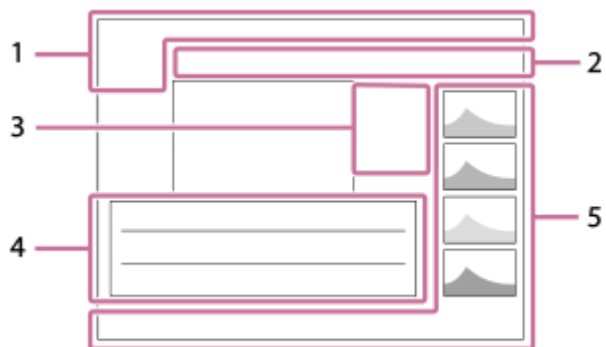

1. Basic information



Rating



Protect

3/7

File number/Number of images in the view mode



Remaining battery



Display as Group



Proxy movie included



Shot Mark included



Smartphone transfer status (when using [ Select on Cam & Send])

2. Camera settings



Connected to Wi-Fi/Disconnected from Wi-Fi



Bluetooth connection available / Bluetooth connection unavailable



Airplane Mode



Overheating warning



Database file full / Database file error

3. Touch operation icons



Shooting mode switching



Add/Delete Shot Mark1



Jump to the positions of Shot Marks

4. Shooting settings



Aspect ratio

20M / 18M / 17M / 13M / 10M / 7.5M / 6.5M / 5M / 4.2M / 3.7M

Image size of still images

RAW

RAW recording

J-X.FINE J-FINE J-STD

JPEG Quality

XAVC S 4K XAVC S HD

File format of movies

120p 100p 60p 50p 30p 25p 24p

Frame rate of movies



Record setting of movies

1/250

Shutter speed

F3.5

Aperture value

ISO400

ISO sensitivity

P A S M

Exposure mode



Exposure compensation



Metering Mode

10mm

Lens focal length



Creative Look

AWB AWB_{AWB} AWB_{AWB} [Sun] [House] [Underwater] [Color temp] [Color filter] 7500K A5 G5

White Balance (Auto, Preset, Underwater Auto, Color temperature, Color filter)



D-Range Optimizer

HLG

HDR recording (Hybrid Log-Gamma)

5. Image information



Latitude/longitude information

2023-1-1 10:37:00PM

Date of recording



100-0003

Folder number - file number

C0003

Movie file number



Histogram (Luminance/R/G/B)

Related Topic

- [List of icons on the screen for shooting movies](#)
- [List of icons on the screen for shooting still images](#)

5-049-603-11(1) Copyright 2023 Sony Corporation

Digital Camera
ZV-1M2

Specifications

System

Camera Type

Digital Camera

Image sensor

Image format

13.2 mm × 8.8 mm (1.0 type), CMOS image sensor

Effective pixel number of camera

Approx. 20 100 000 pixels

Total pixel number of camera

Approx. 21 000 000 pixels

Lens

ZEISS Vario-Sonnar T *

f = 6.9 mm – 17.6 mm

Angle of view: 100° - 47° (35 mm format equivalent: 18 mm - 50 mm)

F1.8 (W) – F4.0 (T)

Auto focus system

Detection system

Phase-detection system/Contrast detection system

Monitor

LCD monitor

7.5 cm (3.0 type) TFT drive, touch panel

Total number of dots

921 600 dots

Recording format

File format

JPEG (compliant with DCF Ver. 2.0, Exif Ver. 2.32, and MPF Baseline), RAW (Sony ARW 4.0 format compliant)

Movie (XAVC S format)

XAVC Ver2.0: MP4 format compliant

Video: MPEG-4 AVC/H.264

Audio: LPCM 2ch (48 kHz 16 bit), MPEG-4 AAC-LC 2ch^{*1}

^{*1} Proxy movies

Recording media

Memory Stick, SD cards

Input/output terminals

USB Type-C terminal

Hi-Speed USB (USB 2.0)

HDMI

HDMI type D micro jack

(Microphone) terminal

Ø 3.5 mm Stereo mini jack

Power, general

Rated input

3.6 V  , 1.9 W

Operating temperature

0 °C to 40 °C (32 °F to 104 °F)

Storage temperature

-20 °C to 55 °C (-4 °F to 131 °F)

Dimensions (W/H/D) (Approx.)

105.5 × 60.0 × 46.7 mm

4 1/4 × 2 3/8 × 1 7/8 in.

Mass (Approx.)

292 g (10.3 oz) (including battery pack, SD card)

Microphone

Stereo

Speaker

Monaural

Exif Print

Compatible

PRINT Image Matching III

Compatible

Wireless LAN

Supported format

IEEE 802.11 b/g/n

Frequency band

2.4 GHz

Security

WEP/WPA-PSK/WPA2-PSK

Connection method

Wi-Fi Protected Setup™ (WPS)/Manual

Access method

Infrastructure mode

Bluetooth communications

Bluetooth standard Ver. 4.2

Frequency band

2.4 GHz

Rechargeable battery pack NP-BX1



Rated voltage

3.6 V 

Design and specifications are subject to change without notice.

5-049-603-11(1) Copyright 2023 Sony Corporation

Trademarks

- Memory Stick and  are trademarks or registered trademarks of Sony Group Corporation.
- XAVC S and  are trademarks of Sony Group Corporation.
- Mac is a trademark of Apple Inc., registered in the United States and other countries.
- USB Type-C® and USB-C® are registered trademarks of USB Implementers Forum.
- The terms HDMI, HDMI High-Definition Multimedia Interface, and the HDMI Logo are trademarks or registered trademarks of HDMI Licensing Administrator, Inc.
- Microsoft and Windows are registered trademarks or trademarks of Microsoft Corporation in the United States and/or other countries.
- SDXC logo is a trademark of SD-3C, LLC.
- Wi-Fi, the Wi-Fi logo and Wi-Fi Protected Setup are registered trademarks or trademarks of the Wi-Fi Alliance.
- The Bluetooth® word mark and logos are registered trademarks owned by Bluetooth SIG, Inc. and any use of such marks by Sony Group Corporation and its subsidiaries is under license.
- QR Code is a trademark of Denso Wave Inc.
- In addition, system and product names used in this manual are, in general, trademarks or registered trademarks of their respective developers or manufacturers. However, the ™ or ® marks may not be used in all cases in this manual.

Digital Camera
ZV-1M2

License

Notes on the License

This product comes with software that are used based on licensing agreements with the owners of that software. Based on requests by the owners of copyright of these software applications, we have an obligation to inform you of the following. Licenses (in English) are recorded in the internal memory of your product. Establish a Mass Storage connection between the product and a computer to read licenses in the "PMHOME" - "LICENSE" folder.

THIS PRODUCT IS LICENSED UNDER THE AVC PATENT PORTFOLIO LICENSE FOR THE PERSONAL USE OF A CONSUMER OR OTHER USES IN WHICH IT DOES NOT RECEIVE REMUNERATION TO

(i) ENCODE VIDEO IN COMPLIANCE WITH THE AVC STANDARD ("AVC VIDEO")

AND/OR

(ii) DECODE AVC VIDEO THAT WAS ENCODED BY A CONSUMER ENGAGED IN A PERSONAL ACTIVITY AND/OR WAS OBTAINED FROM A VIDEO PROVIDER LICENSED TO PROVIDE AVC VIDEO.

NO LICENSE IS GRANTED OR SHALL BE IMPLIED FOR ANY OTHER USE. ADDITIONAL INFORMATION INCLUDING THAT RELATING TO PROMOTIONAL, INTERNAL AND COMMERCIAL USES AND LICENSING MAY BE OBTAINED FROM MPEG LA, L.L.C.

SEE [HTTPS://WWW.MPEGLA.COM](https://www.mpegla.com)

On GNU GPL/LGPL applied software

The software included in this product contains copyrighted software that is licensed under the GPLv2 and other licenses which may require access to source code. You may find a copy of the relevant source code as required under the GPLv2 (and other licenses) at <https://www.sony.net/Products/Linux/>.

You may obtain the source code as required by the GPLv2 on a physical medium from us for a period of three years after our last shipment of this product by applying through the form at <https://www.sony.net/Products/Linux/>.

This offer is valid to anyone in receipt of this information.

Troubleshooting

If you experience trouble with the product, try the following solutions.

- 1 If a message such as “C/E:□□:□□” appears on the screen, refer to the self-diagnosis display.
- 2 Remove the battery pack, wait for about one minute, re-insert the battery pack, then turn on the power.
- 3 Initialize the settings.
- 4 Consult your dealer or local authorized service facility. Additional information on this product and answers to frequently asked questions can be found at our Customer Support Website.
<https://www.sony.net/>

Related Topic

- [Setting Reset](#)

Digital Camera
ZV-1M2

Self-diagnosis display

If a code starting with a letter of the alphabet appears, the self-diagnosis function on this product is working. The last two digits (indicated by □□) will differ depending on the state of this product.

If you cannot solve the problem even after trying the following corrective actions a few times, this product may need repair. Contact your Sony dealer or local authorized Sony service facility.

C:32:□□

- There is trouble with the product's hardware. Turn the power off and on again.

C:13:□□

- This product cannot read or write data on the memory card. Try turning off and on this product again, or taking out and inserting the memory card several times.
- An unformatted memory card is inserted. Format the memory card.
- The inserted memory card cannot be used with this product, or the data is damaged. Insert a new memory card.

E:61:□□

E:62:□□

E:91:□□

- A product malfunction has occurred. Initialize this product, then turn the power on again.

E:94:□□

- There is a malfunction when writing or deleting data. Repair is required. Contact your Sony dealer or local authorized Sony service facility. Be prepared to give all numbers in the error code beginning from the E.

Warning messages

Set Area/Date/Time.

- Set the area, date and time. If you have not used the product for a long time, charge the internal rechargeable backup battery.

Unable to use memory card. Format?

- The memory card was formatted on a computer and the file format was modified. Select [Enter] and then format the memory card. You can use the memory card again, however, all previous data in the memory card is erased. It may take some time to complete the format. If the message still appears, change the memory card.

Memory Card Error

- An incompatible memory card is inserted.
- Formatting has failed. Format the memory card again.

Unable to read memory card. Reinsert memory card.

- An incompatible memory card is inserted.
- The memory card is damaged.
- The terminal section of the memory card is dirty.

Memory card locked.

- You are using a memory card with a write-protect switch or a delete-protect switch with the switch set to the LOCK position. Set the switch to the record position.

Cannot open the shutter since the memory card is not inserted.

- No memory card has been inserted.
- To release the shutter without inserting a memory card into the camera, set [Release w/o Card] to [Enable]. In this case, images will not be saved.

This memory card may not be capable of recording and playing normally.

- An incompatible memory card is inserted.

Unable to display.

- Images recorded with other products or images modified with a computer may not be displayed.
- Processing on the computer such as deletion of the image files may cause inconsistencies in the image database files. Repair the image database files.

Internal temp. high. Allow it to cool.

- The product has become hot because you have been shooting continuously. Turn the power off and cool the product and wait until the product is ready to shoot again.

(Overheating warning)

- You have been recording images for a long time, the product temperature has risen.

 (Database file error)

- The number of images exceeds that for which date management in a database file by the product is possible.

 (Database file error)

- Unable to register to the database file. Import all the images to a computer and recover the memory card.

Image DataBase File error

- There is something wrong in the Image Database File. Select MENU →  /  (Shooting) → [Media] → [ Recover Image DB].

System Error

Camera Error. Turn power off then on.

- Remove the battery pack, and then re-insert it. If the message appears frequently, consult local authorized Sony service facility.

Image Database File error. Recover?

- You cannot record and play back a movie because the Image Database File is damaged. Recover the Image Database File following the on-screen instructions.

Unable to magnify.

Unable to rotate image.

- Images recorded with other products may not be enlarged or rotated.

Cannot create more folders.

- A folder in the memory card has the first three digits “999.” You cannot create any more folders on this camera.

Related Topic

- [Notes on memory card](#)
- [Area/Date/Time Setting](#)
- [Format](#)
- [Release w/o Card](#)
- [Recover Image DB \(still image/movie\)](#)