



Website : <http://biz.lgservice.com>

WASHING MACHINE SERVICE MANUAL

▲ CAUTION

READ THIS MANUAL CAREFULLY TO DIAGNOSE
PROBLEMS CORRECTLY BEFORE SERVICING THE UNIT.

MODEL: WM9500H*A

Any reproduction, duplication, distribution (including by way of email, facsimile or other electronic means), publication, modification, copying or transmission of this Service Manual is **STRICTLY PROHIBITED** unless you have obtained the prior written consent of the LG Electronics entity from which you received this Service Manual. The material covered by this prohibition includes, without limitation, any text, graphics or logos in this Service Manual.

CONTENTS

1. Specifications	3
2. Features and Technical Explanation	4
2-1. Features	4
2-2. Neuro fuzzy Washing time optimization	5
2-3. Water level Control.....	5
2-4. Door Control.....	5
2-5. The Door can not be Opened.....	6
2-6. Door lock lamp Lights.....	6
2-7. Child Lock.....	6
2-8. Water Circulation.....	6
2-9. Steam.....	6
2-10. Drum Light.....	6
3. Part Identification.....	7
4. Installation and Test	8
5. Operation.....	11
5-1. Control Panel Features	11
5-2. Cycle Guide.....	14
5-3. Special Functions	15
5-4. Explanation of Each Process	16
6. Wiring Diagram / Program Chart	18
7. Test Mode.....	19
7-1. Safety Caution.....	19
7-2. Load Test Mode	19
7-3. How To Check the Water Level Frequency Error.....	19
8. Troubleshooting.....	20
8-1. Safety Caution.....	20
8-2. Error Mode Summary	20
8-3. Troubleshooting With Error	20
8-4. Other Troubleshooting.....	22
9. Component Testing Information	34
9-1. Filter Assembly (Line Filter).....	34
9-2. Door Lock Switch Assembly.....	35
9-3. Stator Assembly	37
9-4. Pump Motor Assembly	38
9-5. Inlet Valve Assembly	39
9-6. Heater Assembly	40
9-7. Thermistor Assembly.....	41
10. Disassembly Instructions.....	43
11. Exploded View.....	54
11-1. Cabinet and Control Panel Assembly.....	54
11-2. Drum and Tub Assembly	55
11-3. Dispenser Assembly.....	56

1. SPECIFICATIONS

ITEM		WM9500H*A
COLOR		W : White, V : Stainless Silver, K : Black Stainless
POWER SUPPLY		AC 120 V, 60 Hz
PRODUCT WEIGHT		239lb (108kg)
ELECTRIC POWER CONSUMPTION	WASHING	370 W
	DRAIN MOTOR	80 W
	WASH HEATER	1300 W
REVOLUTION SPEED	WASH	46 rpm
	SPIN	0-1,300 rpm
CYCLES		15
WASH/RINSE TEMPERATURES		5
SPIN SPEEDS		5
OPTIONS		Steam, Smart Grid, Delay Wash Add Garments, Turbo Wash™, Cold Wash Extra Rinse, Pre Wash, Fresh Care, Remote Start, Drum Light, Child Lock
WATER CIRCULATION		Incorporated
OPERATIONAL WATER PRESSURE		20 and 120 psi (138 – 827 kPa)
CONTROL TYPE		Electronic
WASH CAPACITY [cu.ft.]		5.76 DOE
DIMENSIONS		29" 5/8(W)x 34 1/16"(D)x 41 3/16"(H), 56 5/16" (D with door open)
DELAY WASH		up to 19 hours
DOOR TYPE		CHROME
WATER LEVEL		10 steps (by sensor)
LAUNDRY LOAD SENSING		Incorporated
ERROR DIAGNOSIS		Incorporated
AUTO POWER OFF		Incorporated
CHILD LOCK		Incorporated
STEAM		Incorporated

2. FEATURES & TECHNICAL EXPLANATION

2-1. FEATURES



■ Ultra Capacity

The larger drum enables not only higher head drop and stronger centrifugal force, but also less tangling and wrinkling of the laundry. Heavier loads, such as king size comforters, blankets, and curtains, can be washed.



■ Direct Drive System

The advanced brushless DC motor drives the drum directly, without belt or pulley

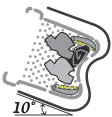

■ Tilted Drum and Extra Large Door Opening

Tilted drum and extra large opening make it possible to load and unload clothing more easily.



■ Steam Washing

Steam washing features upgraded washing performance with low energy and water consumption.



■ Automatic Wash Load Detection

Automatically detects the load and optimizes the washing time.



■ Built-in Heater

Internal heater helps to maintain water temperature at its optimum level for selected cycles.



■ Child Lock

The child lock prevents children from pressing any button to change the settings during operation.

2-2. NEURO FUZZY WASHING TIME OPTIMIZATION

To get the best washing performance, optimal time is determined by the water temperature, the selected washing temperature, and the size of the load.

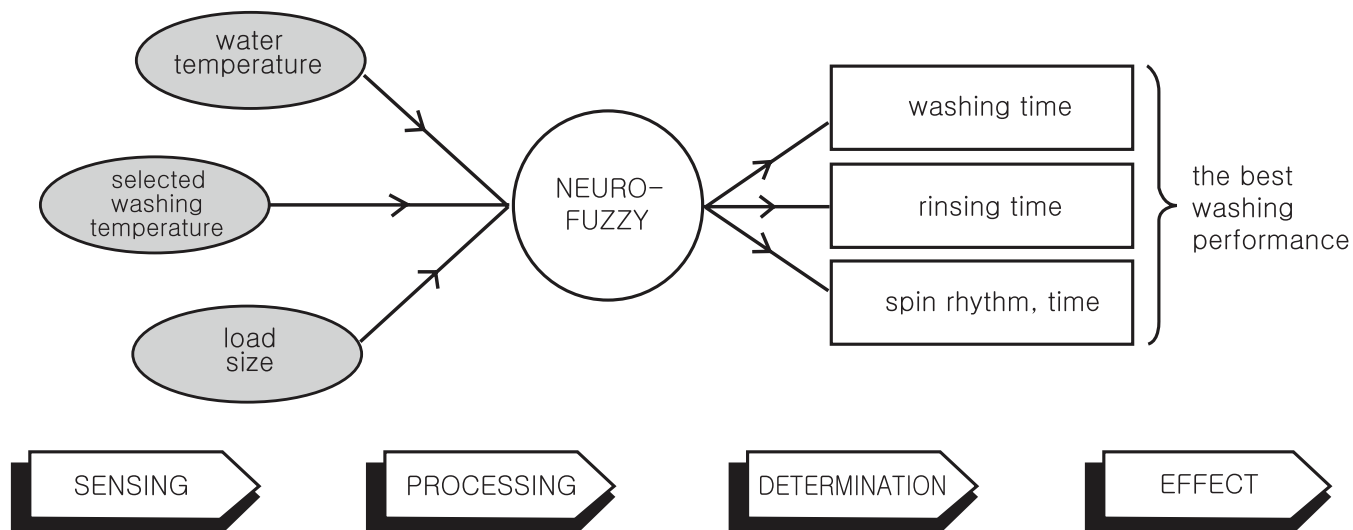

2-3. WATER LEVEL CONTROL

- This model incorporates a pressure sensor which can sense the water level in the tub.
- The water supply is stopped when the water level reaches the preset level. The washing program then proceeds.
- Spinning does not proceed until the water in the tub drains to a certain level.

2-4. DOOR CONTROL

- The door can be opened by pulling the door handle whenever washer is not in operation.
- When the cycle is completed, the DOOR LOCKED light will turn off.
- If a power failure has occurred during operation, the door will unlock after 5 minutes.
- Clicking sounds can be heard when the door is locked/unlocked.

2-5. THE DOOR CAN NOT BE OPENED

- While program is operating.
- During a power failure or if the machine is unplugged while running.
- While door Lock lights turn on.
- While the drum is still turning, even if the machine has been stopped or paused.

2-6. DOOR LOCKED LAMP LIGHTS

- When the frequency of water level is lower than 22.9 kHz.
(It can be canceled when the frequency is more than 23.8 kHz.)
- When the temperature inside the tub is higher than 45°C (113° F) and water level is not 25.5 kHz.
(It can be canceled when the water level is 25.5 kHz or the temperature inside the tub is lower than 40° C (104° F))

2-7. CHILD LOCK

- Use this option to prevent unwanted use of the washer. Press and hold Pre Wash button for 3 seconds to lock/unlock control.
- When child lock is set, CHILD LOCK lights and all buttons are disabled except the POWER  button. You can lock the controls of the washer while washing.
- CHILD LOCK remains in effect after the cycle and even if the power is turned off. To UNLOCK, press and hold the Pre Wash button for 3 seconds.

2-8. WATER CIRCULATION

- The recirculated water sprays from a nozzle at the Slightly below the center of both sides of the door gasket.
- During the wash cycle, it runs continuously for the first three minutes and intermittently after that.
- During the rinse cycle, it runs continuously after the drum is filled.

2-9. STEAM

- For tough stained clothes, sick room linens, or baby clothes.
- Steam Wash is available with Cotton/Normal, Jumbo wash, Heavy duty, Bulky/Large, Bright whites™, Sanitary, Allergiene™ and Tub clean.
- This option features upgraded washing performance with low energy and water consumption.
- Do not load delicates such as wool, silk, and easily discolored clothes.

2-10. DRUM LIGHT

- The drum light comes on when the power button is pressed.
It goes off when the door is closed and the washer starts operation.
- The drum light remains off when the door is locked.
- The drum light can be turned on while the washer is in operation by pressing the Extra Rinse button for 3 seconds.
- The light will turn off automatically 4 minutes later.
- The drum light comes on when the washing cycle is finished and goes off 4 minutes later.

3. PARTS IDENTIFICATION

PART AND ACCESSORIES

Part

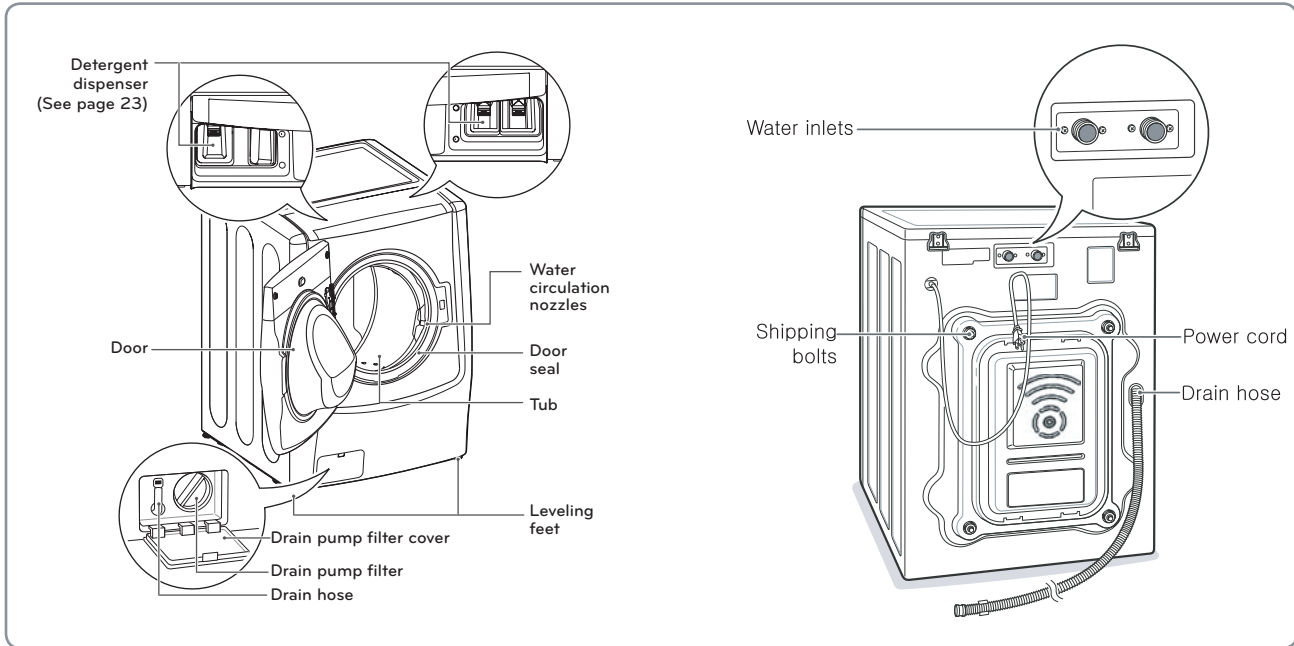

Accessories

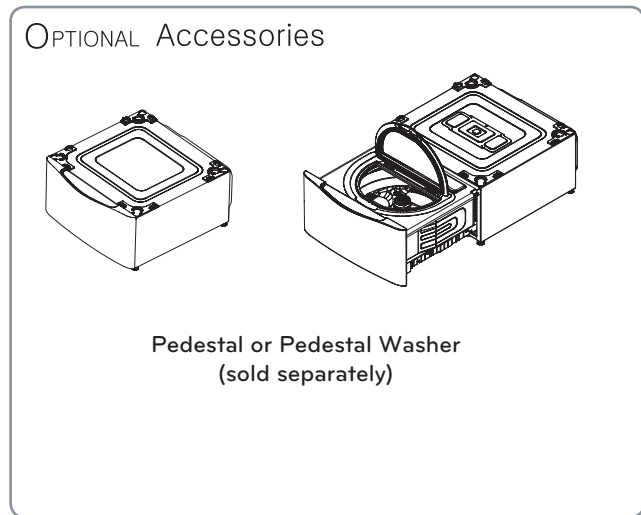
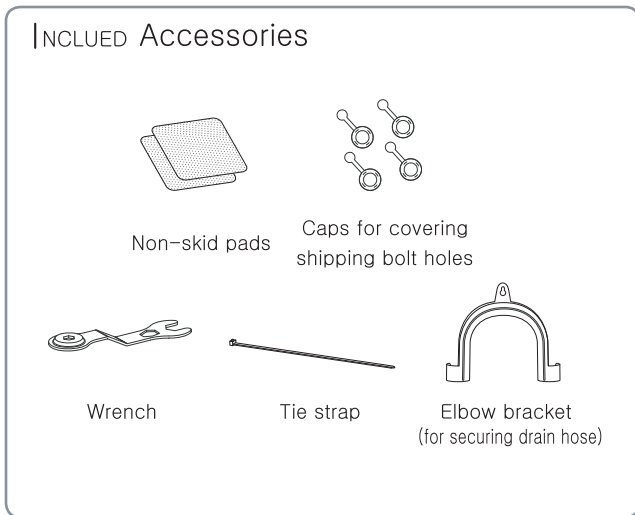

NOTE

- Contact LG Customer Service at 1-800-243-0000 (1-888-542-2623 in Canada) if any accessories are missing.
- For your safety and for extended product life, use only authorized components. The manufacturer is not responsible for product malfunction or accidents caused by the use of separately purchased unauthorized components or parts.
- The images in this guide may be different from the actual components and accessories, and are subject to change by the manufacturer without prior notice for product improvement purposes.

4. INSTALLATION & TEST

- 1 Before servicing, ask the customer what the trouble is.
- 2 When installing or repairing the washer, put on long gloves and safety glasses.
- 3 Check the setup (power supply is 120Vac, remove the transit bolts, level the washer, etc.)
- 4 Check with the troubleshooting guide.
- 5 Plan your service method by referring to the disassembly instructions.
- 6 Service the unit.
- 7 After servicing, operate the appliance to see whether it functions correctly.

■ STANDARD INSTALLATION

The appliance should be installed as follows:

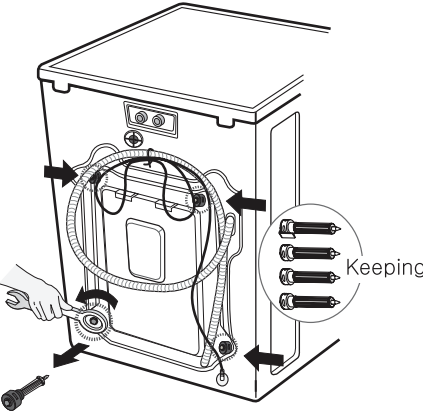
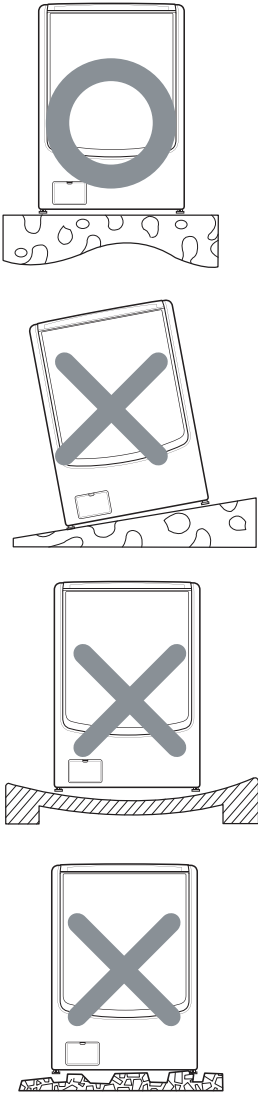
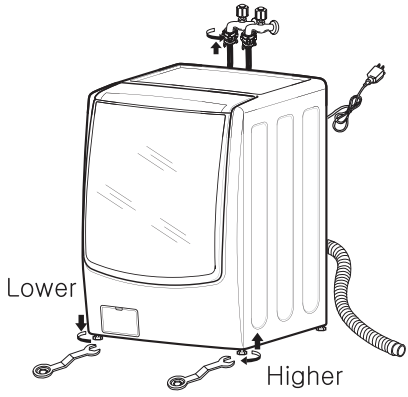
REMOVE THE SHIPPING BOLTS	INSTALL THE APPLIANCE ON A FLAT AND FIRM SURFACE	ADJUST THE LEVELING
<ul style="list-style-type: none"> • Remove the 4 shipping bolts with the supplied wrench. ※ Remove the lower bolts first. It is easier that way. • Keep the shipping bolts and spanner for future use. • Insert the 4 caps (provided) into the hole. 		<ul style="list-style-type: none"> • Turn the leveling feet to adjust the appliance.  <ul style="list-style-type: none"> • Turn clockwise to raise; counterclockwise to lower.

■ HOW TO CONNECT THE INLET HOSE

- Verify that the rubber washer is inside of the end of the hose.
- Tighten the inlet hose securely to prevent leaks.
- Install the inlet hose to correct temperature water tap.

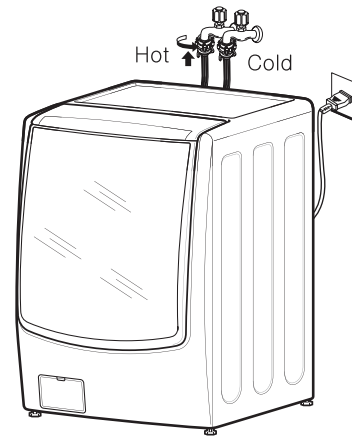

■ CONNECT THE DRAIN HOSE

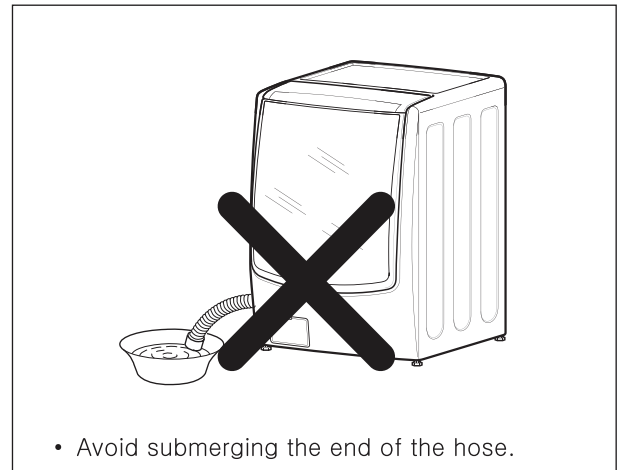
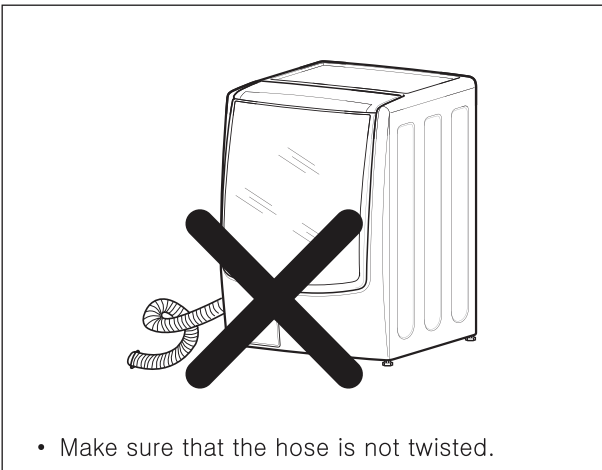

※ The end of the drain hose should be placed less than 96" (8' or 2.4 m) above the floor.

■ CONNECT POWER PLUG

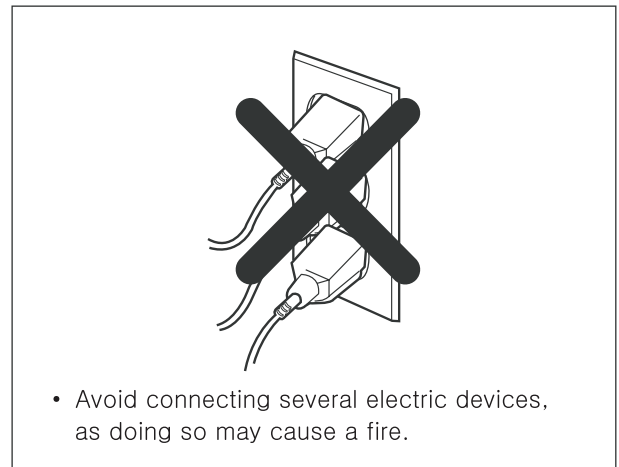
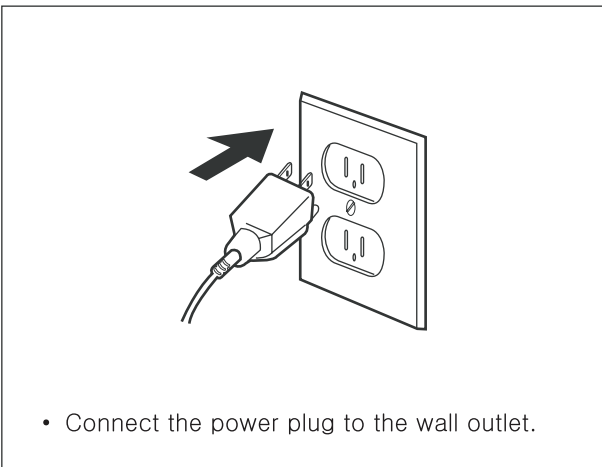

7 TEST OPERATION

1 Preparation for washing.

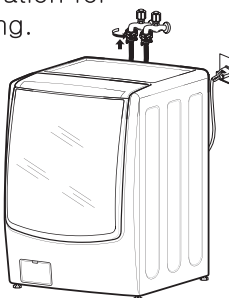

- Connect the power plug to the outlet.
- Connect the inlet hoses.

2 Press the POWER button.

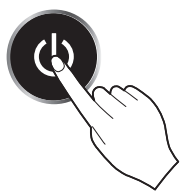

3 Press the START/PAUSE button.



- Listen for a click to determine if the door has locked.



6 Check the water heating function.

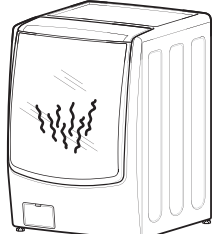

- Press the WASH TEMP button and the present temperature will be displayed.

5 Check the automatic reverse rotation.

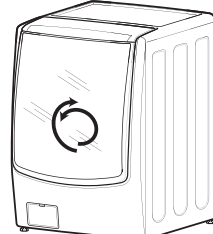

- Check if the drum rotates clockwise and counterclockwise.

4 Check the water supply.

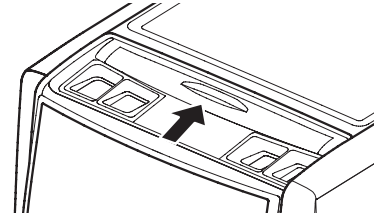

- Check if water is supplied through the detergent dispenser.



7 Check the drain and spin functions.

- Power off and the power on.
- Press the SPIN SPEED button.
- Press the START/PAUSE button.
- Check the spin and drain functions.

8 Press the START/PAUSE button.



- Listen for a click to determine if the door is unlocking.

9 Water removal

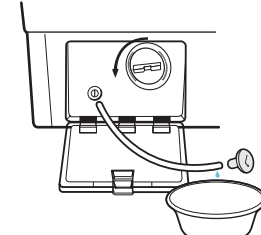



- If SERVICE is needed during check, remove the remaining water by pulling out the hose cap.

5. OPERATION

5-1. CONTROL PANEL FEATURES

■ WM9500H*A





STEAM CYCLE

- Normal
- Heavy Duty
- Bedding
- Perm.Press
- Towels

- Sanitary
- Allergiene™
- Bright Whites™
- Tub Clean
- Jumbo Wash

- Delicates
- Sportswear
- Speed Wash
- Rinse+Spin
- Downloaded



Hold to Start

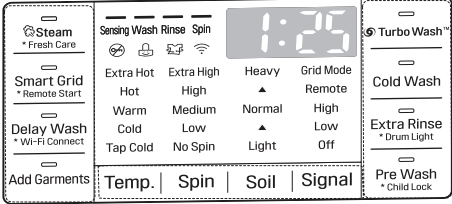

* Press and hold 3secs for extra functions

All Cold Rinses

Power Button

- Use this button to turn the power On/Off.

Status Indicator

- It shows elapsed time of the cycle the washer is operating.

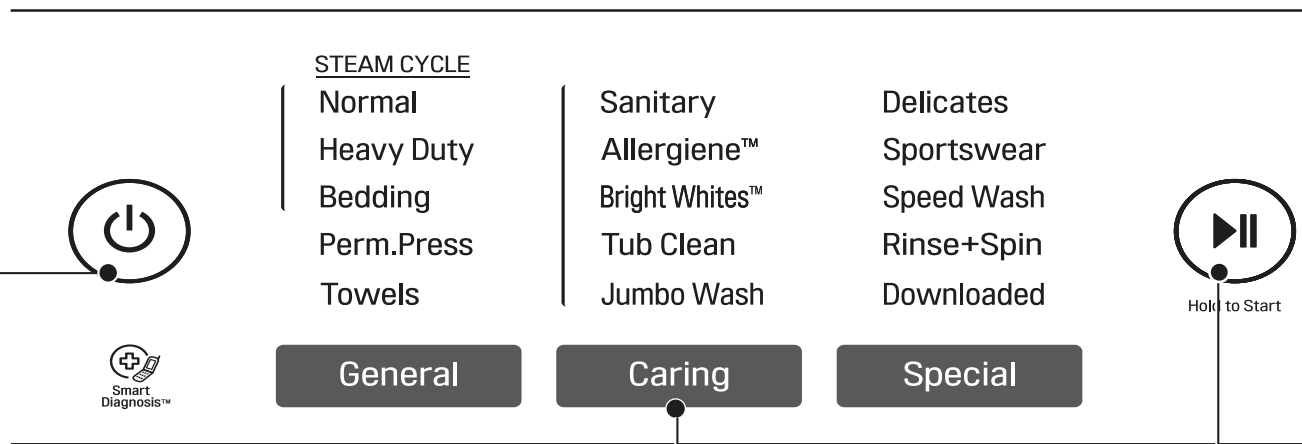

Cycle Selector Button

- Press the Cycle selector button to select the cycle designed for different types of fabric and soil levels.

Start/Pause

- Use this button to Start/Stop the washer.

Option Button

- Steam : Use the Steam button to add steam to the cycle for the extra cleaning.
- Smart Grid : Smart appliances can communicate with local utility companies that are equipped with Smart Grid equipment.
- Delay Wash : Once you have the cycle and other settings, press this button to delay the start of the wash cycle.
- Add Garments : Use this function to add garments or remove foreign objects like coins or keys after the cycle has started.
- Turbo Wash™ : Adding the Turbo Wash™ option reduces cycle time and provides good performance in normal cycle.
- Cold Wash : Use this function to wash without hot water and heating.
- Extra Rinse : You can add an extra rinse cycle to the default rinse cycle.
- Pre Wash : Pre-wash for 15 minutes when clothes are covered in dirt or dust. This feature is suitable for heavily soiled items.

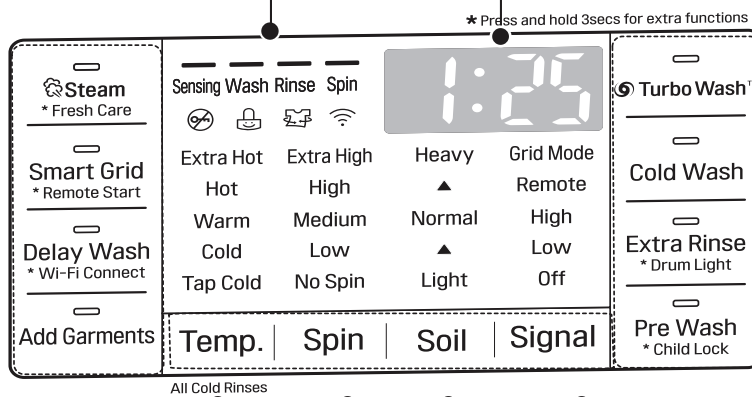

Temp., Spin, Soil, Signal Button

- To change the water temperature, press the Temp. button repeatedly until the desired setting is on.
- To change the spin speed, press the Spin Speed button repeatedly to cycle through available options.
- To change the soil level, press the Soil Level button repeatedly until the desired setting is on.
- To adjust the volume of the signal, press the Signal button repeatedly until the desired setting is on.

5-2. Cycle Guide

The cycle guide below shows the options and recommended fabric types for each cycle.

● = Available option

Cycle	Fabric Type	Basic Option (★=Default)			Additional Options					
		Wash Temp.	Spin Speed	Soil Level	Steam	Cold Wash™	Delay Wash	Extra Rinse	Pre Wash	Turbo Wash™
Bright Whites™	White Fabrics	Hot ★ Warm Cold Tap Cold	Extra High High★ Medium Low No Spin	Heavy Normal★ Light	●		●	●	●	●
Allergiene™	Cotton, underwear, pillow covers, bed sheets, baby wear	-	Extra High High★ Medium Low No Spin		●		●	●		●
Sanitary	Heavily soiled underwear, work clothes, diapers, etc.	Extra Hot★	Extra High High★ Medium Low No Spin	Heavy Normal★ Light	●		●	●	●	●
Bedding	Large items such as blankets and comforters	Hot Warm★ Cold Tap Cold	Medium★ Low No Spin	Heavy Normal★ Light	●	●	●	●	●	●
Heavy Duty	Heavily soiled Cotton Fabrics	Extra Hot Hot Warm★ Cold Tap Cold	Extra High High★ Medium Low	Heavy Normal★ Light	●	●	●	●	●	●
Normal	Cotton, linen, towels, shirts, sheets, jeans, mixed loads	Extra Hot Hot Warm★ Cold Tap Cold	Extra High High★ Medium Low	Heavy Normal★ Light	●	●	●	●	●	●
Jumbo Wash	Comforter	Hot Warm★ Cold Tap Cold	High★ Medium Low No Spin	Heavy Normal★ Light	●	●	●	●	●	●
Perm.Press	Dress shirts/pants, wrinkle-free clothing, poly/cotton blend clothing, tablecloths	Hot Warm★ Cold Tap Cold	High Medium★ Low	Heavy Normal★ Light		●	●	●	●	●
Delicates	Dress shirts/blouses, nylons, sheer or lacy garments	Warm Cold★ Tap Cold	Medium★ Low No Spin	Heavy Normal★ Light		●	●	●	●	
Towels	Towels	Hot Warm★ Cold Tap Cold	Extra High★ High Medium Low No Spin	Heavy Normal★ Light		●	●	●	●	●
Speed Wash	Lightly soiled clothing and small loads	Hot★ Warm Cold Tap Cold	Extra High★ High Medium Low No Spin	Heavy Normal Light★		●	●	●		●
Rinse + Spin	Rinse, drain and spin only	Cold★	Extra High High★ Medium Low No Spin	-			●	●		
Tub Clean	This cycle is designed to remove a mildewy or musty smell.				●		●			
Downloaded * Default Small Load	Normally soiled and small loads.	Hot Warm★ Cold Tap Cold	Extra High High★ Medium Low No Spin	Heavy Normal★ Light		●	●	●	●	
Sports Wear	Sports Wear	Warm★ Cold Tap Cold	Medium★ Low No Spin	Normal★ Light			●	●		

Cycle time depends on type and amount of load and detergent, water pressure and chosen additional options.

- If the Turbo Wash™ option is on, you cannot select No Spin as your Spin.

(If the Turbo Wash™ option is off, you can select No Spin as your Spin.)

5-3. SPECIAL FUNCTIONS

The option buttons also activate special functions, including **Fresh Care**, **Remote Start**, **Wi-Fi Connect**, **PGM Save**, **Drum Light** and **Child Lock**. Press and hold the option button marked with the special function for 3 seconds to activate.

Fresh Care



Use this option to make laundry less stressful by intermittent tumbling action. This option helps to reduce moisture in the load. Press and hold the **Steam** button for 3seconds to activate or deactivate **Fresh Care**.

Remote Start



Use a smart phone to control your appliance remotely. Also, it is possible to monitor your cycle operation so you know how much time is left in the cycle.

Wi-Fi Connect



Use this option for connecting to the internet through your home Wi-Fi network

DRUM LIGHT



The drum is equipped with a white LED light that illuminates when the washer is turned on. This light automatically turns off when the door is closed and the cycle starts. To turn on the light during a cycle, press and hold the **Extra Rinse** button for 3 seconds. The drum light will illuminate and then turn off automatically after 4 minutes.

CHILD LOCK



Use this option to prevent unwanted use of the washer or to keep cycle settings from being changed while the washer is operating. Press and hold the **Pre Wash** button for 3seconds to activate or deactivate **Child Lock**. **Child Lock** will be shown in the display, and all controls are disabled except the ON/OFF button. The washer can be locked during a cycle.

NOTE: **Child Lock** lasts after the end of cycle. If you want to deactivate this function, Press and hold the **Pre Wash** button for 3 seconds.

5-4. Explanation of each process

No.	Process	Explanation
1.	Stand-by	<ul style="list-style-type: none"> • Electrical power is supplied. • Washer is ready to work and the micom is in the active mode.
2.	Water supply	<ul style="list-style-type: none"> • After loading laundry and selecting a course and a cycle, water is supplied and the drum rotates. • When the user selects PRE-WASH, water is supplied through the pre-wash valve.
3.	Soaking and washing laundry	<ul style="list-style-type: none"> • To get laundry wet, the drum rotates clockwise and counterclockwise. • If water amount is insufficient at this time, the inlet valve will supply water again.
4.	Heating and washing	<ul style="list-style-type: none"> • The heater heats the water in drum to the selected water temperature and drum rotates for washing.
5. 6.	Washing and heating / washing	<ul style="list-style-type: none"> • When the water temperature reaches to the selected temperature, the heating stops but drum rotation continues. • If water temperature becomes lower than selected because of re-supplied water, the heating starts again.
7.	Washing	<ul style="list-style-type: none"> • Fuzzy logic decides washing time according to the laundry load, water temperature, and other factors.
8.	Drainage	<ul style="list-style-type: none"> • A pump motor drains the water from the drum. • When the pressure switch indicates the water has been drained, spin starts. • When very hot water is selected, in the hot, Allergiene, or sanitary cycle, the load is cooled before the door can be opened to prevent damage to the laundry or a burn hazard.
9.	Untangling (Sensing eccentricity)	<ul style="list-style-type: none"> • It balances laundry load and senses the eccentricity of the load, to allow spinning without vibration. • If the eccentricity is worse than the allowed level, it repeats the disentangling process. When the repeated time is more than the allowed level, it displays UE. • When the balance is corrected, the spin cycle begins • During this process, the drain pump works as needed to expel the water extracted from the load.

No.	Process	Explanation
10.	Intermittent spin	<ul style="list-style-type: none"> To reach the correct set speed, the motor rotates clockwise and counterclockwise directions after spin process starts. If the water level frequency is lower than 23.0 kHz, a washer senses suds and starts suds removal process.
11.	Rinse spin	<ul style="list-style-type: none"> In this process, the remaining water during washing process is extracted and the selected speed is kept. Removing suds process is in active mode at this cycle.
12.	Remaining spin	<ul style="list-style-type: none"> After spin finishes, the drum rotates by remaining spin power until it stops. Motor power is off. This process is overlapped with next process.
13.	Rinse water supply	<ul style="list-style-type: none"> Water supply for rinse process.
14.	Rinse	<ul style="list-style-type: none"> Rinsing process.
15.	Last drainage	<ul style="list-style-type: none"> After spin finishes and power is not supplied to motor, the drum coasts to a stop. If rinse hold is selected, the water remains in the tub and the drain pump is not operated.
16.	Disentangling	<ul style="list-style-type: none"> The same as item 9.
17.	Intermittent spin	<ul style="list-style-type: none"> The same as item 10.
18.	Main spin1	<ul style="list-style-type: none"> The same as item 11.
19.	Main spin1	<ul style="list-style-type: none"> At the end of a main spin, the spin speed will reach the selected rpm
20.	Remaining spin	<ul style="list-style-type: none"> The same with item 12.
21.	isentangling	<ul style="list-style-type: none"> After spin finishes, disentangling starts to remove unbalanced laundry.
22.	End	<ul style="list-style-type: none"> After end signal is displayed, it stays for 8 seconds and power is automatically turned off. (Auto type door switch) After door switch is off, end signal is displayed in the case of manual type and it takes around 2 minute to turn off door switch.

6. WIRING DIAGRAM / PROGRAM CHART

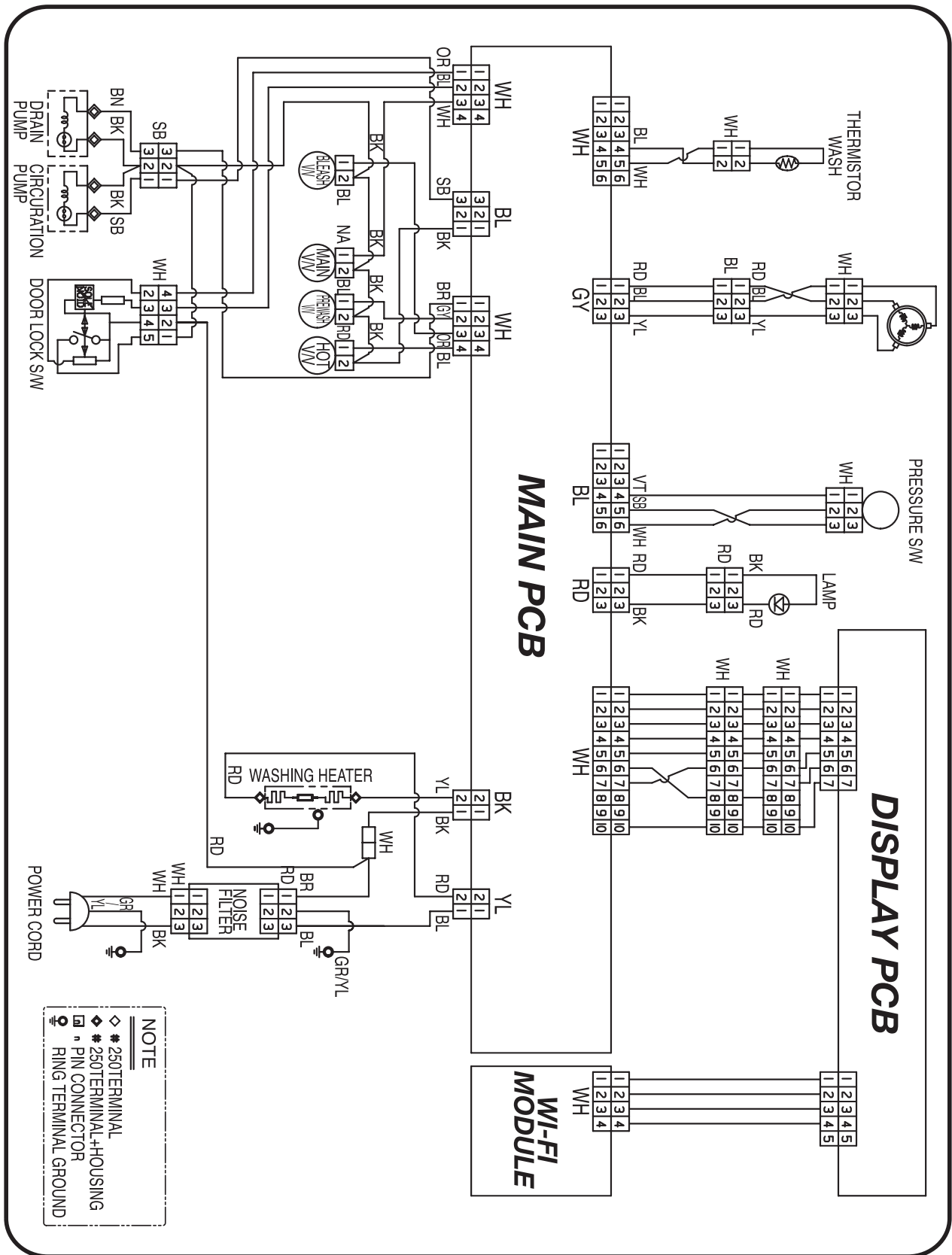

7. TEST MODE

7-1. SAFETY CAUTION

- There can be live AC and DC voltage on some terminals on the main board, even when the machine is turned off. Be cautious to avoid electric shock when disconnecting parts while troubleshooting. (Wear Static Discharge gloves when working.)
- After cutting off the power when changing the PWB disconnecting, or reassembling.
- Be careful static when handling the PWB assembly, and use Electro Static Discharge plastic pack when shipping or storing it.

7-2. LOAD TEST MODE

The washer must be empty and the controls must be in the off state.

1. Hold the **Spin and Soil**.

2. Then buzzer will sound twice.

3. Press the Start/Pause (⏸) button repeatedly to cycle through the test modes.

Number of times the Start/Pause button is pressed	Check Point	Display Status
None	Turns on all lamps and locks the door.	LOAD TEST MODE
1 time	Tz, Rz connectiong check.	Connecting Success("go") Connecting Failure("-")
2 times	Tumble clockwise.	Rpm (45~50)
3 times	Low speed spin.	Rpm (55~60)
4 times	High speed spin.	Rpm (110~115)
5 times	Inlet valve for prewash turns on.	Water level frequency (0~255)
6 times	Inlet valve for main wash turns on.	Water level frequency (0~255)
7 times	Inlet valve for hot water turns on.	Water level frequency (0~255)
8 times	Inlet valve for bleach turns on.	Water level frequency (0~255)
9 times	Tumble counterclockwise.	rpm (42~50)
10 times	Heater turns on for 3 seconds.	Water temperature
11 times	Circulation pump turns on.	Water level frequency (25~65)
12 times	Drain pump turns on.	Water level frequency (25~65)
13 times	off	-

7-3. HOW TO CHECK THE WATER LEVEL FFREQUENCY

Press and hold the **Soil and Delay Wash** button simultaneously.

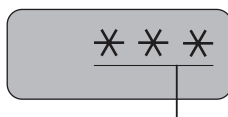

● The digits indicate the water level frequency (x.1 kHz).
So, for example a display indicating 241: a Water level frequency of 241 x.1 kHz
= 24.1 kHz

8. TROUBLESHOOTING





8-1. SAFETY CAUTION

- There can be live AC and DC voltage on terminals on the main board, even when the machine is turned off. Be cautious to avoid electric shock when disconnecting parts while troubleshooting. (Wear Electro Static Discharge gloves when working.)
- After cutting off the power when changing the PWB assembly, disconnecting, or reassembling.
- Be careful static when handling the PWB assembly, and use Electro Static Discharge plastic pack when shipping or storing it.

8-2. ERROR MODE SUMMARY

- If you press the START/PAUSE button when an error is displayed, any error except **PE** will disappear and the machine will go into the pause status.
- In case of **PE**, **UE**, **DE** if the error is not resolved within 20 seconds, or the in case of other errors, if the error is not resolved within 4 minutes, power will be turned off automatically and the error code will blink. But in the case **FE**, power will not be turned off.

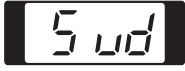
	ERROR	SYMPTOM	CAUSE
1	WATER INLET ERROR	IE	<ul style="list-style-type: none"> • Correct water level (24.6kHz) is not reached within 8 minutes after water is supplied or it does not reach the preset water level within 20 minutes.
2	UNBALANCE ERROR	UE	<ul style="list-style-type: none"> • The load is too small. • The appliance is tilted. • Laundry is gathered to one side. • Non-distributable things are put into the drum.
3	DRAIN ERROR	DE	<ul style="list-style-type: none"> • Not fully drained within 10 minutes.
4	OVERFLOW ERROR	FE	<ul style="list-style-type: none"> • Water is overflowing. (water level frequency is over 21.3kHz). ※ If FE is displayed, the drain pump will operate to drain the water automatically.
5	PRESSURE SENSOR ERROR	PE	<ul style="list-style-type: none"> • The PRESSURE SENSOR ASSEMBLY is out of order. • When water level frequency is consistently below 10 kHz or over 30 kHz.
6	DOOR OPEN ERROR	dE1 dE2	<ul style="list-style-type: none"> • Door not all the way closed. • Loose electrical connections at door switch and PWB Assembly. • The DOOR SWITCH ASSEMBLY is out of order.
7	HEATING ERROR	LE	<ul style="list-style-type: none"> • The THERMISTOR is out of order.

	ERROR	SYMPTOM	CAUSE
8	LOCKED MOTOR ERROR		<ul style="list-style-type: none"> The connector (3-pin, male, white) in the MOTOR HARNESS is not connected to the connector (3-pin, female, white) of STATOR ASSEMBLY. The electric contact between the connectors (3-pin, male, white) in the MOTOR HARNESS and 4-pin, female, white connector in the MAIN PWB ASSEMBLY is bad or unstable. The MOTOR HARNESS between the STATOR ASSEMBLY and MAIN PWB ASSEMBLY is cut (open circuited). The hall sensor is out of order/defective.
9	EEPROM ERROR		<ul style="list-style-type: none"> EEPROM is out of order. ※ Displayed only when the START/PAUSE button is first pressed in the Load Test Mode.
10	POWER FAILURE		<ul style="list-style-type: none"> After the power supply is stopped while washing machine is working, the power is supplied rapidly.
11	SUD ERROR		<ul style="list-style-type: none"> If the washing machine detects too many suds, it displays this error code and adds a Suds Reducing cycle. This adds about two hours to the cycle time. If too many suds are detected during spinning, the washing machine stops to help prevent leaking.
12	WIFI ERROR		<ul style="list-style-type: none"> WIFI Modem is not connected.
			<ul style="list-style-type: none"> WIFI Modem Self Check function Error

8-3. TROUBLESHOOTING WITH ERROR

INLET VALVE ERROR

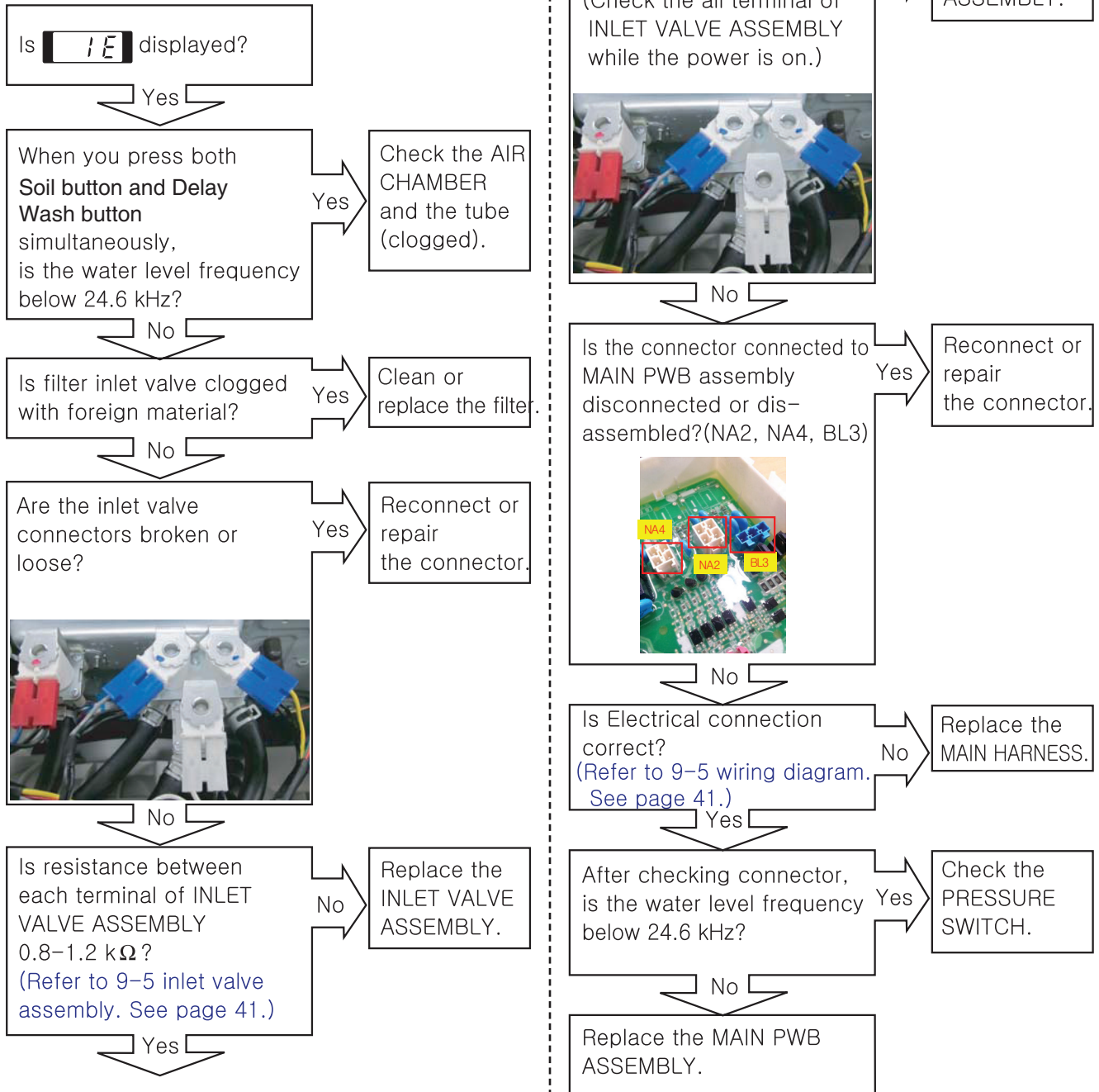

[Note] Installation safety check list

- 1) No water tap leakage
- 2) No water tap freeze
- 3) No entanglement of water supply hose
- 4) No water shortage
- 5) No shrinkage on water supply hose due to a possible misuse of hot and cold water
- 6) No water supply hose leakage

DRAIN ERROR

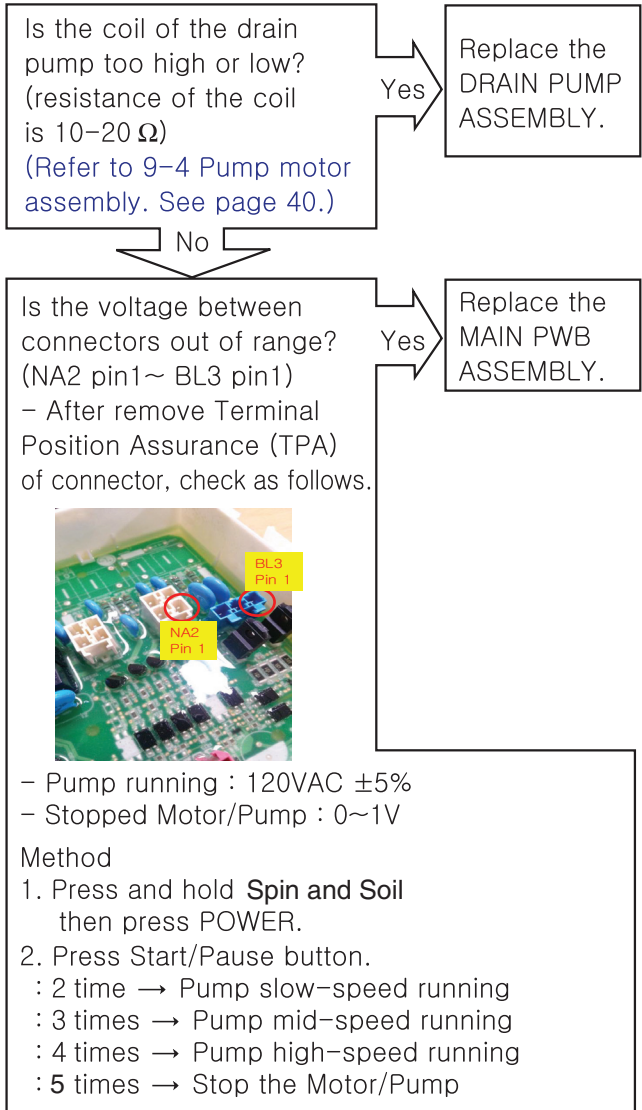
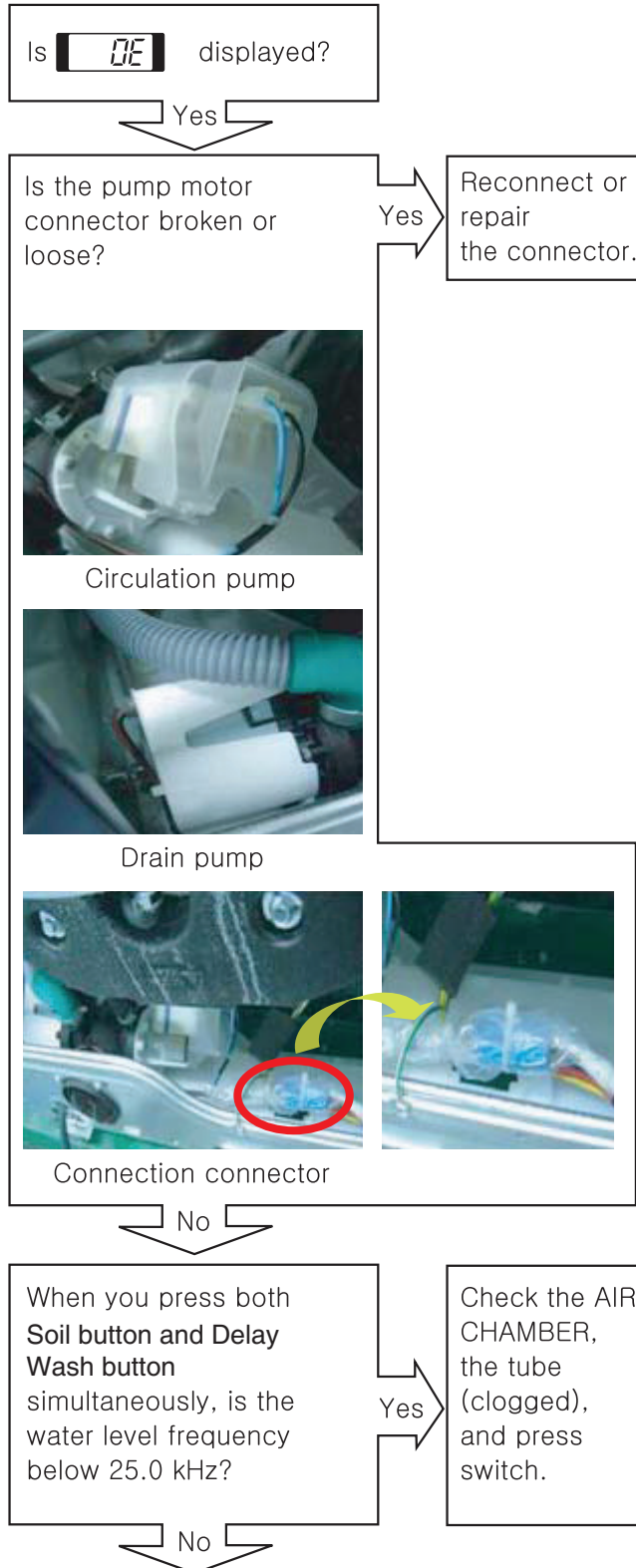

[Note] Installation check list

- 1) The drainage hose must not stay in a lower position.
- 2) The drainage hose must not be bent or clogged in any way due to the surrounding physical configuration.
- 3) The drainage hose must not get frozen at all times.
- 4) The drainage pump must not have any improper substance or material inside that may cause a machine breakdown.

HEATING ERROR

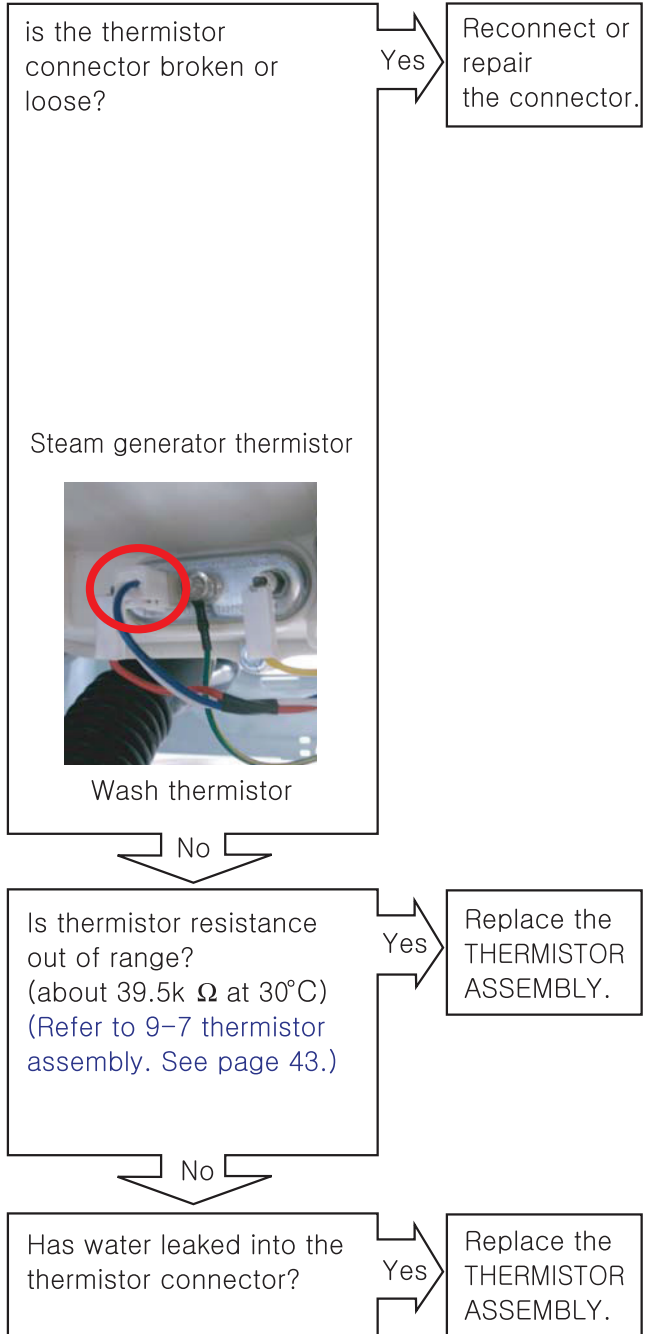
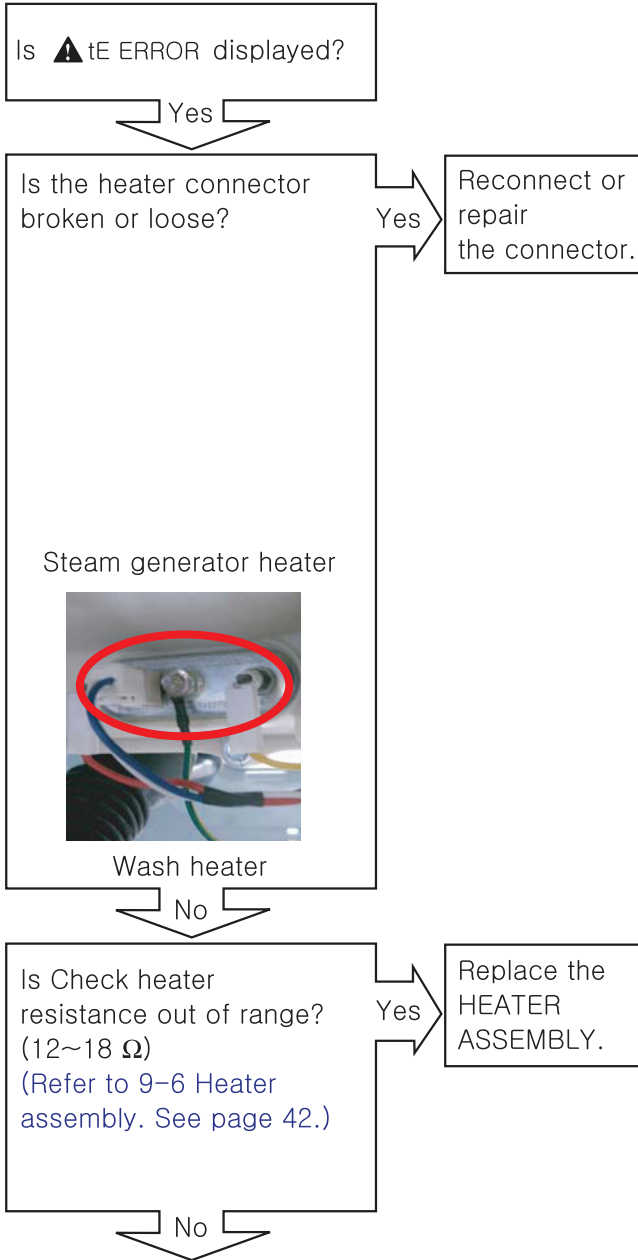

[Note]

A control board failure is rare. The sensing parts of the thermistor circuit are only resistors and capacitors.

LOCKED MOTOR ERROR

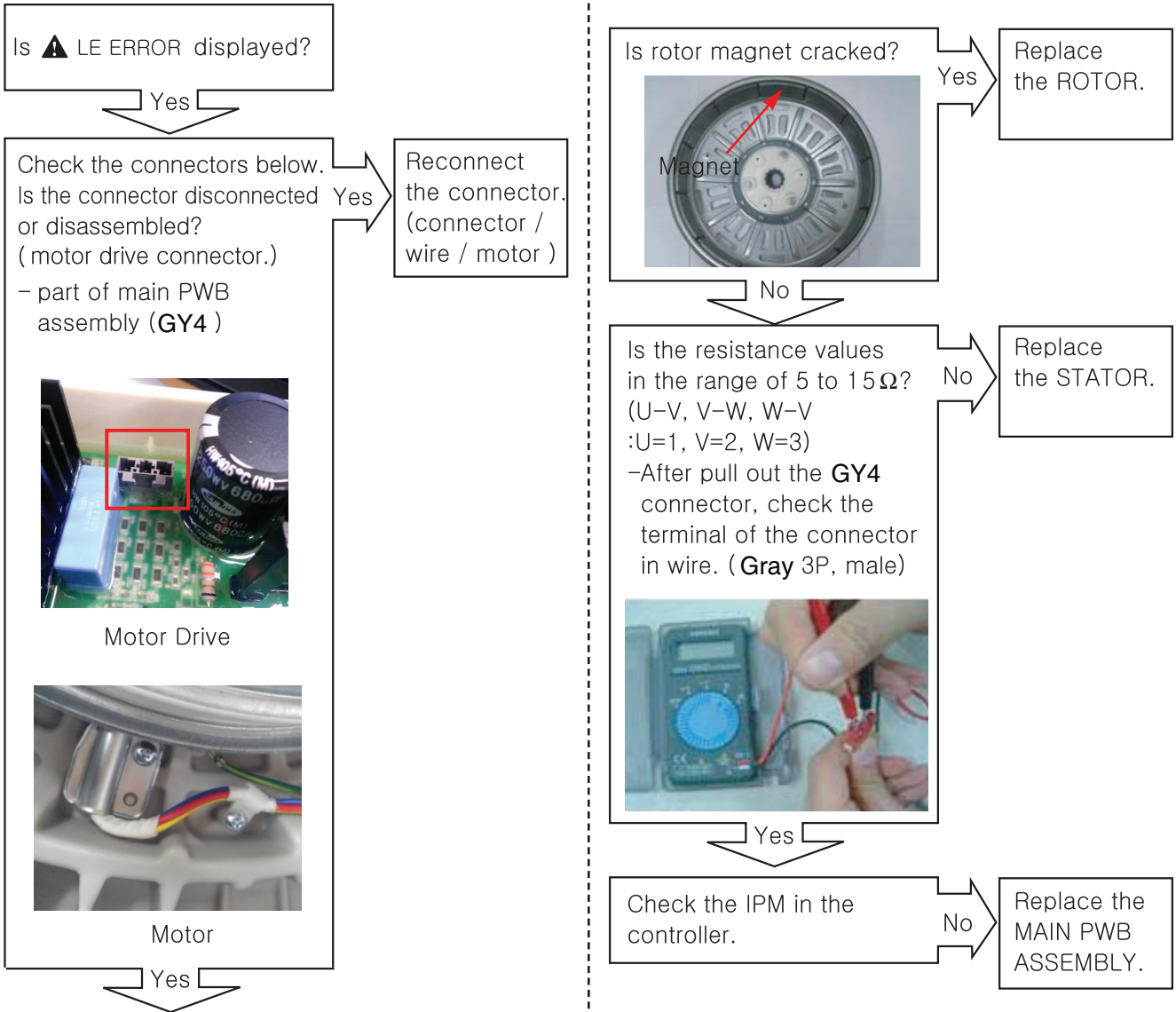

DOOR OPEN ERROR

Is  or  displayed?

Yes

Check the connectors at the door switch and the main board. Are they loose or broken?

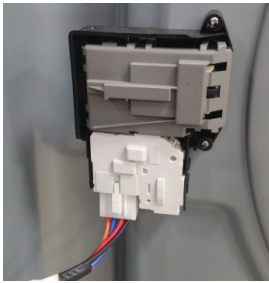

Yes

Is the latch hook spring adjusted properly?



Yes

No

Reconnect or repair the connector.

No

Replace Door Assembly.

Is there clicking sound once or twice when the **START/PAUSE** button is pressed to start the cycle?

No

Replace the PCB ASSEMBLY.

Yes

Is DOOR SWITCH ASSEMBLY broken?

No

Replace the DOOR SWITCH ASSEMBLY.

[Note] Installation check list

- 1) The machine must operate with all the doors completely closed and locked.
- 2) The washing area must operate with a water temperature not higher than 45 Celsius and should not be overfilled.

UNBALANCE ERROR

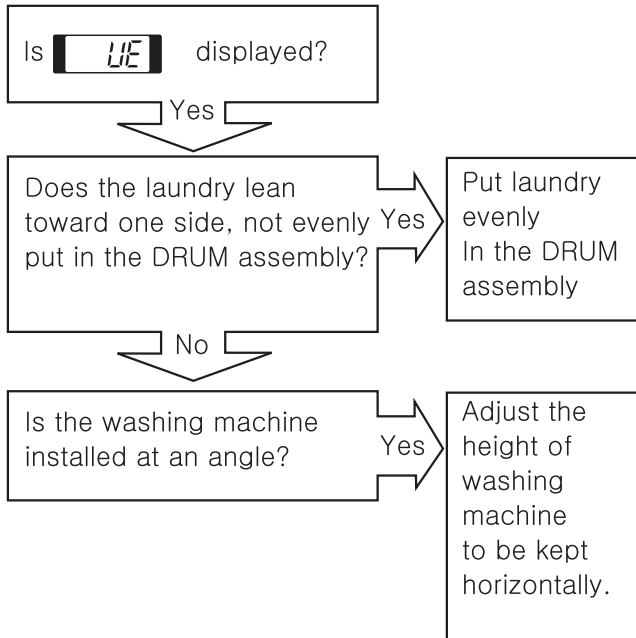

[Note] Installation check list

- 1) Remove the transit bolts. (4)
- 2) Confirmation on the material to see if it is capable of handling two different types of blanket materials.

OVER FLOW ERROR

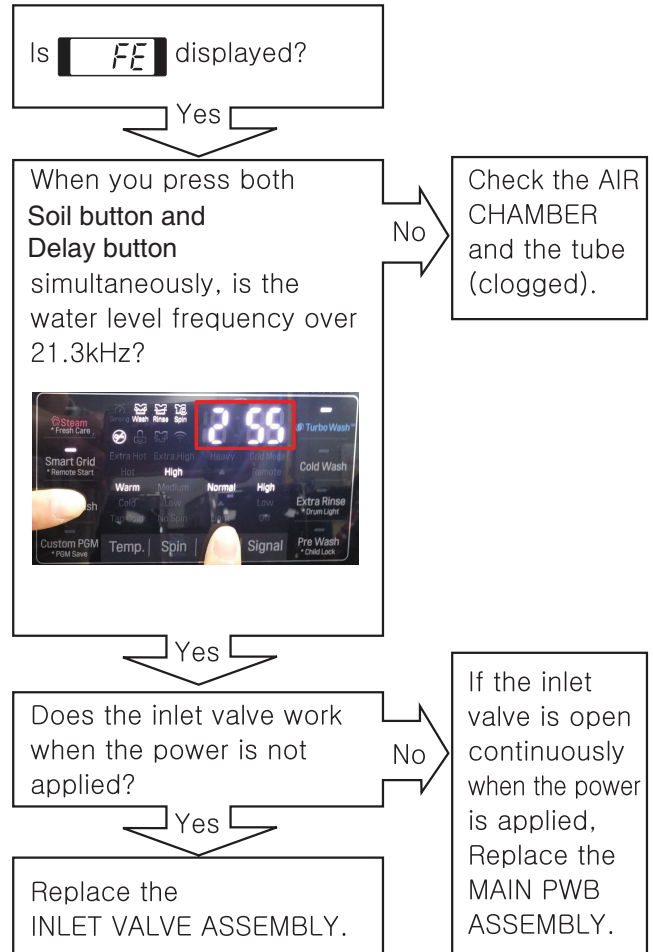

PRESSURE SENSOR ERROR

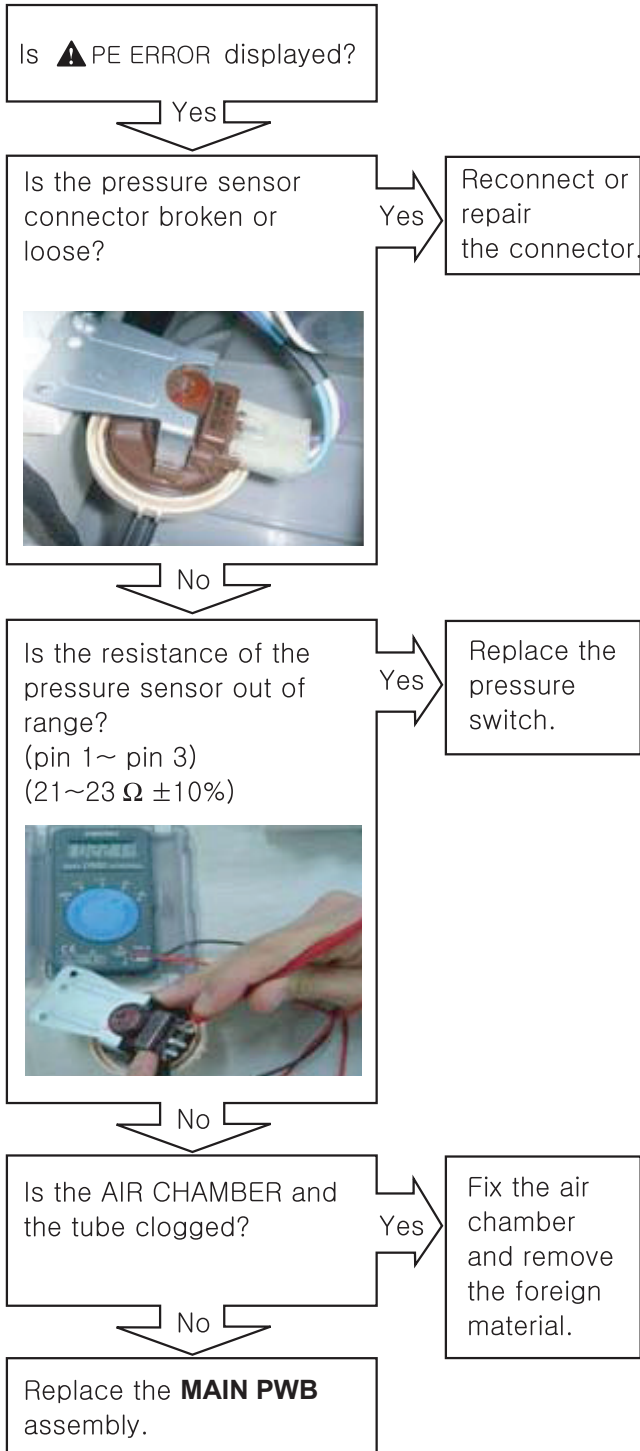

8-4. OTHER TROUBLESHOOTING

⚠ CAUTION

1. Be careful of electric shock if disconnecting parts while troubleshooting.
2. First of all, check the connection of each electrical terminal with the wiring diagram.
3. If you replace the MAIN PWB ASSEMBLY, reinsert the connectors correctly.

NO POWER

Is the supplied voltage 120V AC?(+10%, -15%)

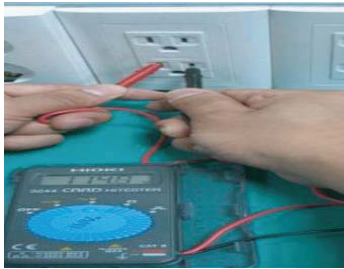

Yes

No

Check the fuse or reset the circuit breaker.

We usually tell the user to use a single-outlet circuit and NOT to use a power strip or multiple-outlet connector.



Yes

No

Alternate with explanation.

Are the PCB and noise filter connectors broken or loose?



Yes

No

Reconnect or repair the connector.

Is LED on while the power is on?



Yes

No

Replace the MAIN PWB ASSEMBLY.

Is the 5-pin wire from the display board loose or damaged?

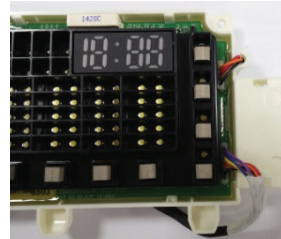

Display PWB

No

Replace the DISPLAY PWB ASSEMBLY.



Connecting connector MAIN PWB~ Display PWB

BUTTON DOESN'T WORK

Are the connectors to the MAIN board and DISPLAY board damaged or broken?

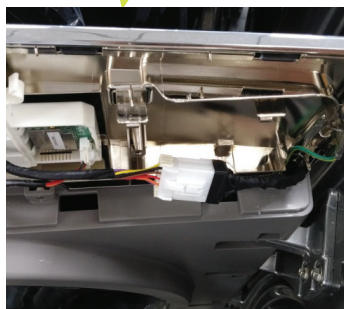

No

Is the button of panel stuck?

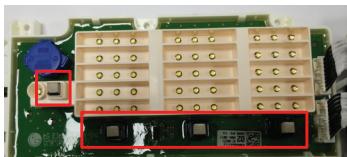

Yes

Reconnect or Repair the connector.

Yes

Repair the button.

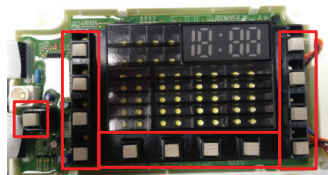

No

Is the display PCB broken? (check the buzzer sound and LED light while push the button.)

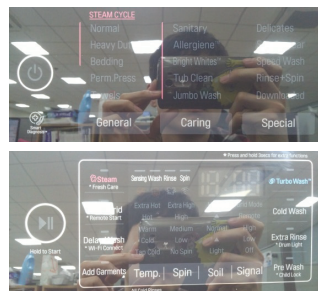

Yes

Replace the DISPLAY PWB ASSEMBLY.

VIBRATION & NOISE IN SPIN

Have all the transit bolts and base packing been removed?

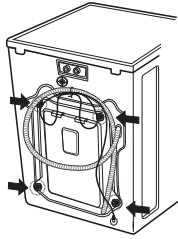

Base Packing

Yes

No

Remove the transit bolts and base packing.

Is the washer installed on a solidly constructed floor?

Yes

No

Move the washer or reinforce the floor.

Check if the washer is perfectly level as follows:

Check the leveling of the washer with a level and check that the washer is stable.

Level

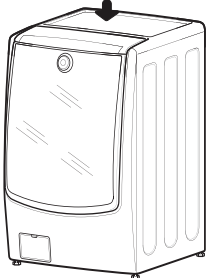

Put an unbalance part (rubber) inside of drum and start QC test mode and run in high spin.

(Refer to section 7.2, page 19.)
When the machine is spinning in high speed, verify that it is stable.

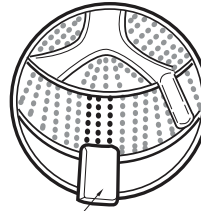

Unbalance Part

If you do not have the unbalance part, put 4.5 to 6.5 lbs (2 to 3 kg) of clothing. Once loaded, press power, Rinse+Spin and the start/pause button in sequence. When the machine is spinning in high speed, verify that it is stable.

Yes

If it is not stable, adjust feet accordingly. After the washer is level, tighten the lock nuts up against of the base of the washer. All lock nuts must be tightened.

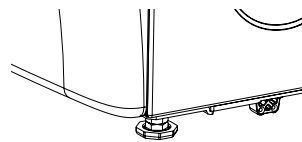

DETERGENT DOES NOT FLOW IN

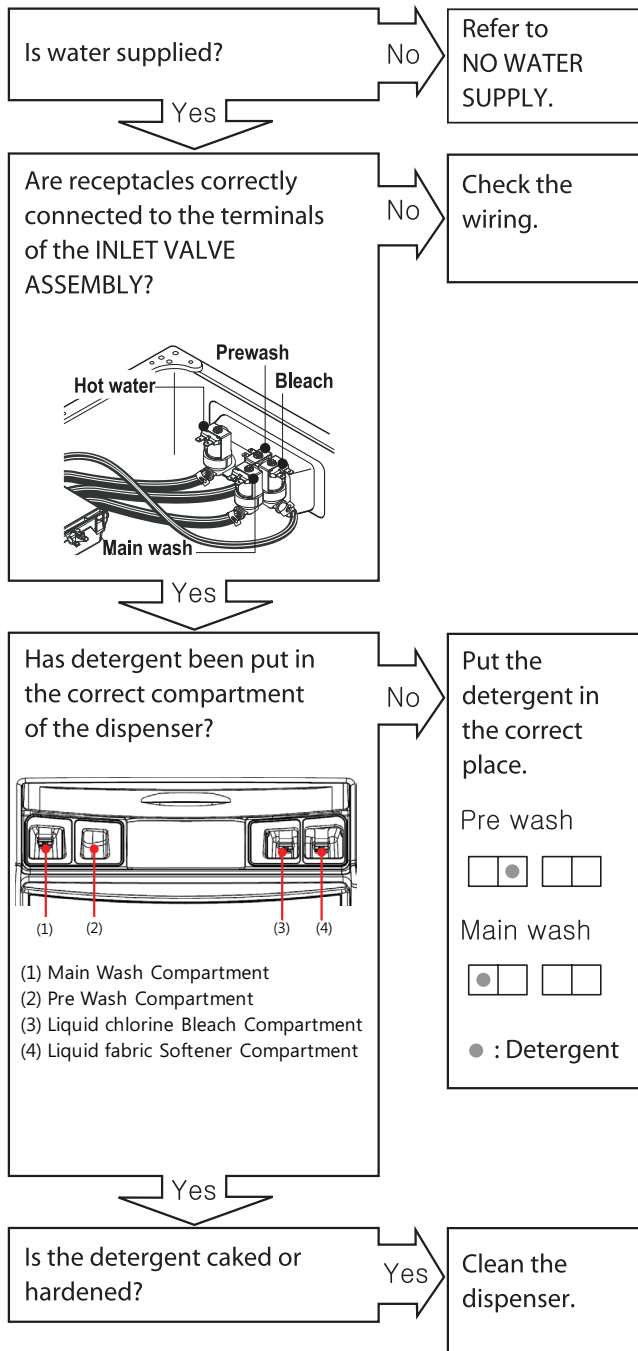

LIQUID DETERGENT/SOFTENER/ BLEACH DOES NOT FLOW IN

Is water supplied? No

Yes

Refer to
NO WATER
SUPPLY.

Are the plugs correctly connected to the terminals of the INLET VALVE ASSEMBLY? No

Yes

Check the wiring on the dispenser.

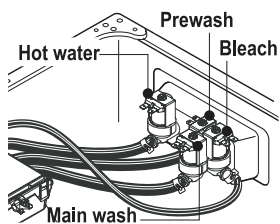

Is liquid detergent/softener/bleach put in the correct compartment of the drawer? No

Yes

Put it in the correct compartment.

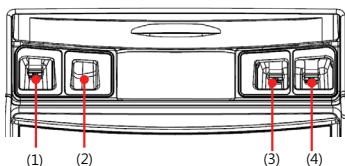

- (1) Main Wash Compartment
- (2) Pre Wash Compartment
- (3) Liquid chlorine Bleach Compartment
- (4) Liquid fabric Softener Compartment

Is the liquid detergent/softener/bleach cap clogged? Yes

No

Clean the cap and container.

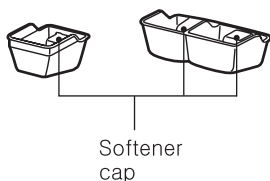

ABNORMAL SOUND

Is the motor bolt loosened? Yes

No

Secure the bolt.

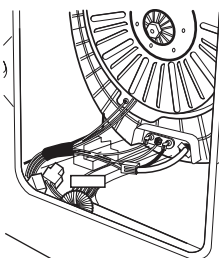

Is there friction noise coming from the motor? Yes

No

Check hall sensor. Replace If defective. Then check stator. Replace if necessary. Check rotor for broken magnets. Replace rotor if necessary.

9. COMPONENT TESTING INFORMATION

⚠ WARNING When Resistance (Ohm) checking the component, be sure to turn the power off, and do voltage discharge sufficiently.

9-1. FILTER ASSEMBLY (LINE FILTER)

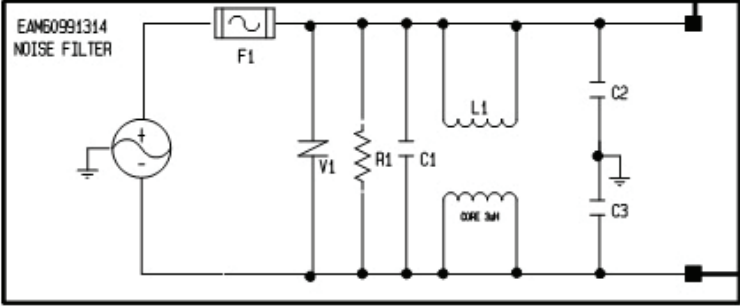
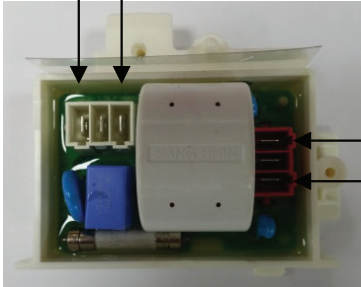
<p>Wiring diagram</p>	<p>Circuit in the MAIN PWB / Wiring Diagram</p> 						
<p>Test points and Result</p>	 <table border="1" data-bbox="670 1340 1144 1495"> <thead> <tr> <th>Test Points</th> <th>Result</th> </tr> </thead> <tbody> <tr> <td>WH (3) to RD (3)</td> <td>0 Ω</td> </tr> <tr> <td>WH (1) to RD (1)</td> <td>0 Ω</td> </tr> </tbody> </table>	Test Points	Result	WH (3) to RD (3)	0 Ω	WH (1) to RD (1)	0 Ω
Test Points	Result						
WH (3) to RD (3)	0 Ω						
WH (1) to RD (1)	0 Ω						

9-2. DOOR LOCK SWITCH ASSEMBLY

<p>Wiring diagram</p>	<p style="text-align: center;">Circuit in the MAIN PWB / Wiring Diagram</p>
<p>Function</p>	<p>The door lock switch assembly consists of a heating PTC, a bimetal, a protection PTC, and a solenoid. It locks the door during the wash cycle.</p> <ol style="list-style-type: none"> 1. Operation for door closing <ul style="list-style-type: none"> - After the system turns on, PTC heating starts up through terminals 2 and 4 authorizing the power on. - After PTC heating starts up and before solenoid operation is driven, force the system to the off position through CAM. ⇒ Door close - Authorizing one impulse through terminal 3~4 (PTC & solenoid) will make the door locked. - Door lock is detected when switches in terminal 4~5 are set closed. ⇒ CAM rotation will forcibly clear off the connection. <li style="padding-left: 20px;">The maximum, allowable number of impulse authorizations is 2. ⇒ Upon the third authorization of the impulse, the position of CAM goes back to the door-open position. - Authorizing the impulse occurs in 4.5 seconds upon input for max performance and two authorization processes are allowed at most. ⇒ Normal operation period of PTC heating: 1.5 – 5 seconds. 2. Operation for door opening <ul style="list-style-type: none"> - With a temporary stop, door automatically opens by CAM rotations after authorizing the impulse from the terminal, 3 ~ 4 and the power turns off – maximum of 3 times of the authorizing period. - Upon the fourth authorization of the impulse, the position of CAM goes back to the door-close position.

<p>Test points</p>																
<p>Result</p>	<table border="1" data-bbox="462 1055 1230 1312"> <thead> <tr> <th>Test Points</th> <th>Result</th> <th>Remarks</th> </tr> </thead> <tbody> <tr> <td>(2) to (4)</td> <td>700-1500Ω</td> <td>At 77°F (25°C)</td> </tr> <tr> <td>(3) to (4)</td> <td>60-90Ω</td> <td>At 77°F (25°C)</td> </tr> <tr> <td>(4) to (5)</td> <td>Infinity</td> <td></td> </tr> <tr> <td>(2) to (4)</td> <td>120 Vac</td> <td>Voltage Input</td> </tr> </tbody> </table>	Test Points	Result	Remarks	(2) to (4)	700-1500Ω	At 77°F (25°C)	(3) to (4)	60-90Ω	At 77°F (25°C)	(4) to (5)	Infinity		(2) to (4)	120 Vac	Voltage Input
Test Points	Result	Remarks														
(2) to (4)	700-1500Ω	At 77°F (25°C)														
(3) to (4)	60-90Ω	At 77°F (25°C)														
(4) to (5)	Infinity															
(2) to (4)	120 Vac	Voltage Input														

9-3. STATOR ASSEMBLY

<p>Wiring diagram</p>	<p style="text-align: center;">Circuit in the MAIN PWB / Wiring Diagram</p>								
<p>Function</p>	<p>The Direct Drive motor can be driven from stopped to maximum speed in infinite steps in either direction.</p> <p>There are 36 poles on the stator; 12 permanent magnets spaced around the rotor. There are no brushes to wear out. Unlike a more traditional brushless motor, the rotor surrounds the stator rather than being attached to it.</p>								
<p>Test points (Windings)</p>									
<p>Result (Windings)</p>	<table border="1" style="width: 100%; border-collapse: collapse;"> <thead> <tr> <th style="text-align: center;">Test Points</th> <th style="text-align: center;">Result</th> </tr> </thead> <tbody> <tr> <td style="text-align: center;">(1) to (2)</td> <td style="text-align: center;">5-15 Ω</td> </tr> <tr> <td style="text-align: center;">(2) to (3)</td> <td style="text-align: center;">5-15 Ω</td> </tr> <tr> <td style="text-align: center;">(3) to (1)</td> <td style="text-align: center;">5-15 Ω</td> </tr> </tbody> </table>	Test Points	Result	(1) to (2)	5-15 Ω	(2) to (3)	5-15 Ω	(3) to (1)	5-15 Ω
Test Points	Result								
(1) to (2)	5-15 Ω								
(2) to (3)	5-15 Ω								
(3) to (1)	5-15 Ω								

9-4. PUMP MOTOR ASSEMBLY

<p>Wiring diagram</p>	<div style="display: flex; justify-content: space-around;"> <div style="border: 1px solid black; padding: 5px; width: 45%;"> <p style="text-align: center; background-color: #cccccc;">Circuit in the MAIN PWB</p> <p style="text-align: center;">Pump Driving circuit</p> </div> <div style="border: 1px solid black; padding: 5px; width: 45%;"> <p style="text-align: center; background-color: #cccccc;">Wiring Diagram</p> </div> </div>												
<p>Object</p>	<div style="display: flex; justify-content: space-around; margin-top: 5px;"> For Drain For Circulation </div>												
<p>Function</p>	<p>Two pump motors are used to drain the tub and to circulate the water / detergent solution.</p>												
<p>Test points</p>	<div style="display: flex; justify-content: space-around;"> <div style="text-align: center;"> <p>Drain Pump</p> <p>(1)(2)</p> </div> <div style="text-align: center;"> <p>Circulation Pump</p> <p>(1)(2)</p> </div> <div style="text-align: center; margin-left: 20px;"> </div> </div>												
<p>Result</p>	<table style="width: 100%; border-collapse: collapse;"> <thead> <tr> <th colspan="2" style="text-align: center; border: none;">Drain Pump</th> <th colspan="2" style="text-align: center; border: none;">Circulation Pump</th> </tr> <tr> <th style="border: 1px solid black; padding: 5px;">Test Points</th> <th style="border: 1px solid black; padding: 5px;">Result</th> <th style="border: 1px solid black; padding: 5px;">Test Points</th> <th style="border: 1px solid black; padding: 5px;">Result</th> </tr> </thead> <tbody> <tr> <td style="border: 1px solid black; padding: 5px; text-align: center;">(1) to (2)</td> <td style="border: 1px solid black; padding: 5px; text-align: center;">10-20Ω</td> <td style="border: 1px solid black; padding: 5px; text-align: center;">(1) to (2)</td> <td style="border: 1px solid black; padding: 5px; text-align: center;">18-30Ω</td> </tr> </tbody> </table>	Drain Pump		Circulation Pump		Test Points	Result	Test Points	Result	(1) to (2)	10-20Ω	(1) to (2)	18-30Ω
Drain Pump		Circulation Pump											
Test Points	Result	Test Points	Result										
(1) to (2)	10-20Ω	(1) to (2)	18-30Ω										

9-5. INLET VALVE ASSEMBLY

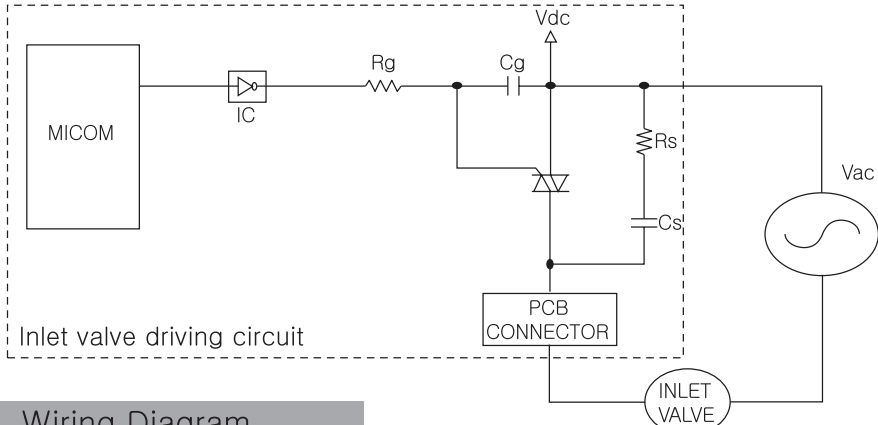
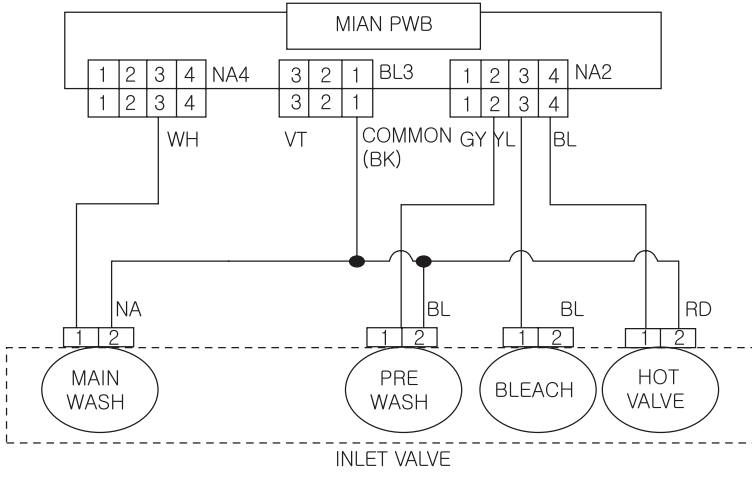
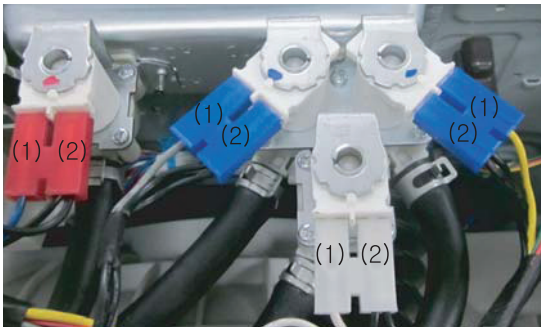
<p>Wiring diagram</p>	<div style="text-align: center; background-color: #cccccc; padding: 5px; margin-bottom: 10px;">Circuit in the MAIN PWB</div>  <div style="text-align: center; background-color: #cccccc; padding: 5px; margin-top: 10px;">Wiring Diagram</div> 				
<p>Function</p>	<p>Depending on the cycle and water temperature, the controller will energize the hot or cold water valve solenoids to regulate the selected water temperature.</p>				
<p>Test points and Result</p>	<p>Remove the connector from the valve and check the resistance.</p>  <table border="1" style="margin-left: auto; margin-right: auto;"> <tr> <td>Test points</td> <td>(1)-(2)</td> </tr> <tr> <td>Result</td> <td>0.8-1.2k Ω</td> </tr> </table>	Test points	(1)-(2)	Result	0.8-1.2k Ω
Test points	(1)-(2)				
Result	0.8-1.2k Ω				

9-6. HEATER ASSEMBLY

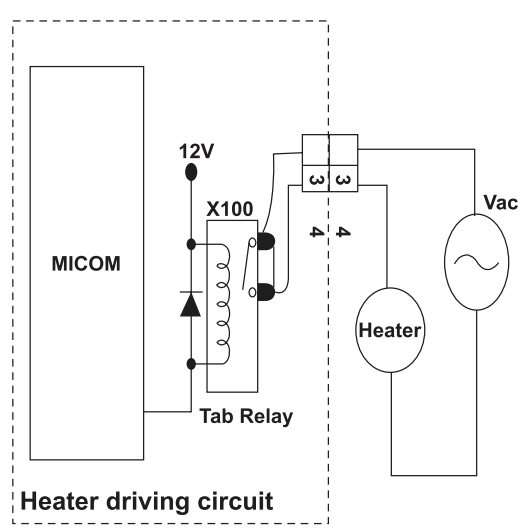
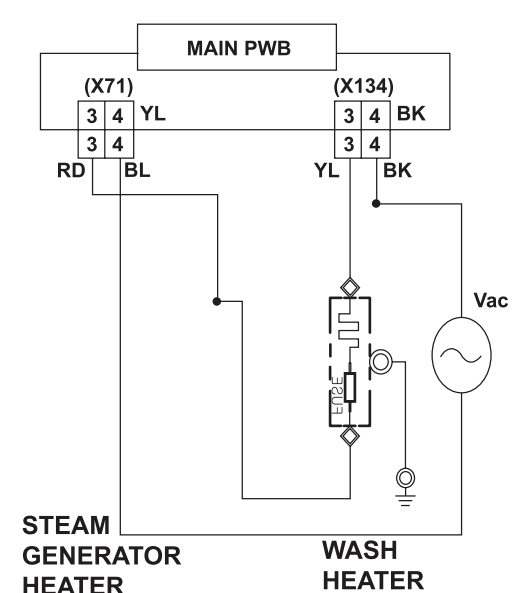
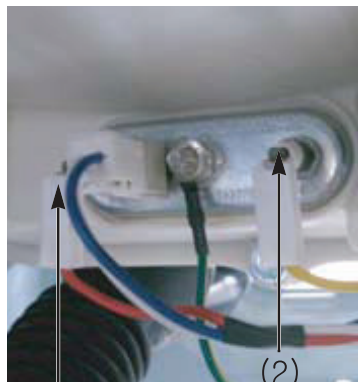
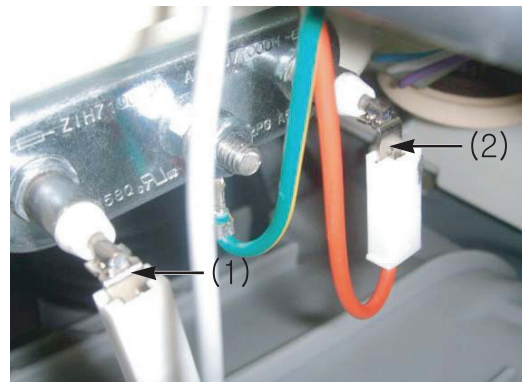
<p>Wiring diagram</p>	<div style="display: flex; justify-content: space-around;"> <div style="border: 1px solid black; padding: 5px; background-color: #f0f0f0; width: 45%;"> <p style="text-align: center;">Circuit in the MAIN PWB</p>  <p style="text-align: center;">Heater driving circuit</p> </div> <div style="border: 1px solid black; padding: 5px; background-color: #f0f0f0; width: 45%;"> <p style="text-align: center;">Wiring diagram</p>  <p style="text-align: center;">STEAM GENERATOR HEATER WASH HEATER</p> </div> </div>												
<p>Function</p>	<ol style="list-style-type: none"> 1. The wash heater is designed to raise the wash water to the desired temperature selection during certain wash cycles. 2. The steam generator heater is designed to make steam during steam cycles. 												
<p>Test points</p>	<div style="display: flex; justify-content: space-around;"> <div style="text-align: center;">  <p>(1) Wash Heater</p> </div> <div style="text-align: center;">  <p>Steam Generator Heater</p> </div> </div>												
<p>Result</p>	<div style="display: flex; justify-content: space-around;"> <table border="1" style="width: 45%; text-align: center;"> <thead> <tr> <th colspan="2">Wash Heater</th> </tr> <tr> <th>Test Points</th> <th>Result</th> </tr> </thead> <tbody> <tr> <td>(1) to (2)</td> <td>12-18 Ω</td> </tr> </tbody> </table> <table border="1" style="width: 45%; text-align: center;"> <thead> <tr> <th colspan="2">Steam Generator Heater</th> </tr> <tr> <th>Test Points</th> <th>Result</th> </tr> </thead> <tbody> <tr> <td>(1) to (2)</td> <td>12-18 Ω</td> </tr> </tbody> </table> </div>	Wash Heater		Test Points	Result	(1) to (2)	12-18 Ω	Steam Generator Heater		Test Points	Result	(1) to (2)	12-18 Ω
Wash Heater													
Test Points	Result												
(1) to (2)	12-18 Ω												
Steam Generator Heater													
Test Points	Result												
(1) to (2)	12-18 Ω												

9-7. THERMISTOR ASSEMBLY

<p>Wiring diagram</p>	<p style="text-align: center;">Circuit in the MAIN PCB / Wiring Diagram</p> <p>The diagram illustrates the electrical connection between the Wash Thermistor and the MAIN PWB. On the left, the thermistor is connected to a connector labeled 'WH' with pins 1, 2, 1, 2. The main circuit on the right, enclosed in a dashed box labeled 'MAIN PWB', shows a 5V supply connected through a resistor (R) to pin 5 of the 'WH' connector. Pin 6 is connected to another resistor (R) and a capacitor (C) to ground. The circuit also includes a MICOM component and various other resistors and capacitors.</p>
<p>Function</p>	<p>The thermistor (temperature sensor) is used to monitor water temperature in the tub or steam generator.</p>
<p>Test points</p>	<p>The photograph shows the physical Wash Thermistor assembly. Two test points are indicated by arrows and labeled (1) and (2). The thermistor is mounted on a metal base with a connector. The test points are located on the wiring harness.</p> <p style="text-align: center;">Wash Thermistor</p>

Result**Wash Thermistor**

Test Points	Result (tolerance $\pm 5\%$)	Remarks
(1) to (2)	39.5 k Ω	At 86°F (30°C)
	26.1 k Ω	At 104°F (40°C)
	12.1 k Ω	At 140°F (60°C)
	8.5 k Ω	At 158°F (70°C)
	3.8 k Ω	At 203°F (95°C)
	2.8 k Ω	At 221°F (105°C)

Steam generator Thermistor

Test Points	Result (tolerance $\pm 5\%$)	Remarks
(1) to (2)	39.5 k Ω	At 86°F (30°C)
	26.1 k Ω	At 104°F (40°C)
	12.1 k Ω	At 140°F (60°C)
	8.5 k Ω	At 158°F (70°C)
	3.8 k Ω	At 203°F (95°C)
	2.8 k Ω	At 221°F (105°C)
	2.1 k Ω	At 241°F (116°C)
	1.4 k Ω	At 266°F (130°C)
	1.0 k Ω	At 293°F (145°C)
	0.7 k Ω	At 320°F (160°C)
	0.4 k Ω	At 356°F (180°C)

10. DISASSEMBLY INSTRUCTIONS

* Be sure to unplug the machine before disassembling and repairing the parts.

CONTROL PANEL



① Unscrew 6 screws on the back of the door.

② Pull the Display PWB cover.

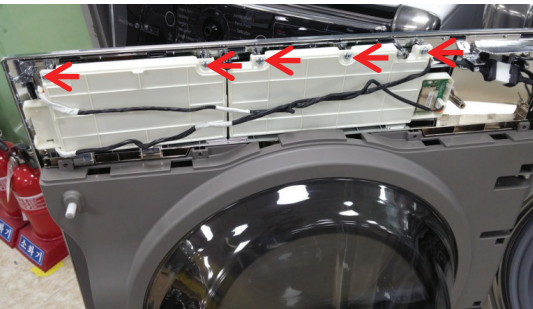

③ Unscrew 5 screws on the back of the display PWB assembly.

TOP PLATE ASSEMBLY



① Remove the dispenser covers.



② Unscrew 4 screws on dispensers.

※ NOTE

· Be careful not to scratch the Dispenser lid.



③ Unscrew 2 screws on the back of the top plate.

④ Pull the top plate backward and upward as shown.

MAIN PWB ASSEMBLY

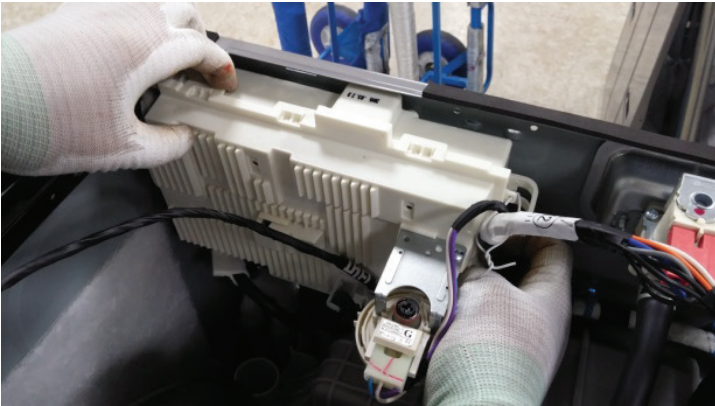

- ① Disconnect the POWER connector and the pressure switch assembly.
- ② Remove the protective cover.



- ③ Disconnect the connectors.



- ④ Unscrew 1 screw on the back.
- ⑤ Remove the main PWB.

DISPENSER ASSEMBLY



- ① Unscrew 2 screws from the front of the panel frame.



- ② Unscrew the clamp nut at the lower part of the dispenser.



- ③ Separate the bellows..



- ④ Disassemble the 3 connectors from the valves.

※ Wire Color

- ① Blue Housing (YL-BK)
- ② White Housing (WH-BK)
- ③ Blue Housing (GY-BK)
- ④ Red Housing (BL-BK)

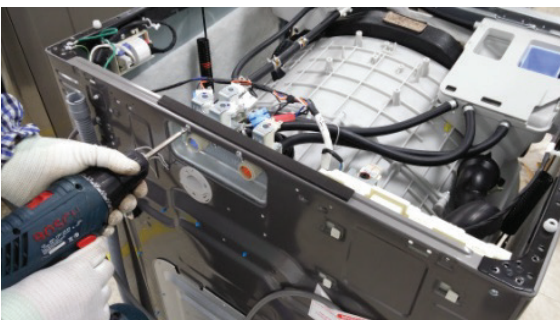

- ⑤ Unscrew 2 screws from the back of the cabinet.

NOISE FILTER

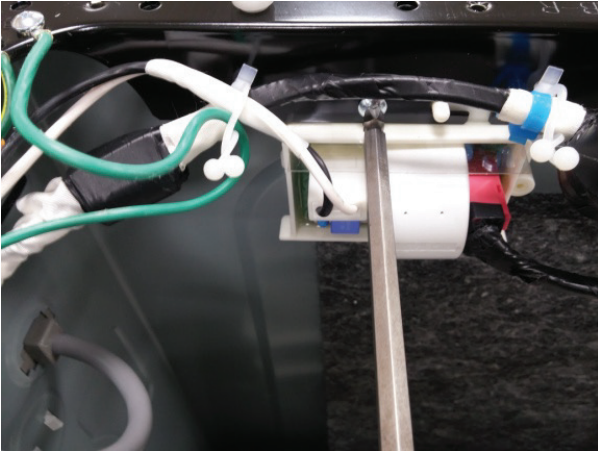

- ① Disassemble two (or three) connectors from the noise filter.
- ② Unscrew a screw from the top bracket.

CABINET COVER

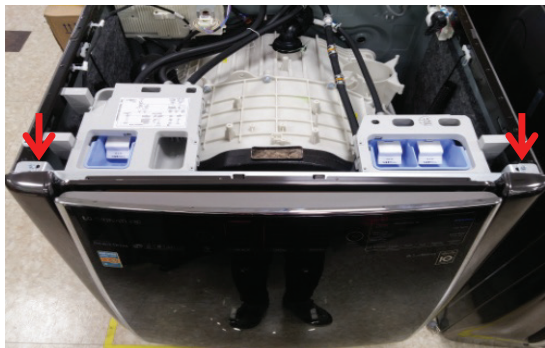

- ① Unscrew the 2 screws from upper of the cabinet cover.



- ② Unscrew the 2 screws from front of the cabinet cover.



- ③ Unscrew the 2 screw from filter cover.



- ④ Unscrew the screw from the cabinet cover.



- ⑤ Disassemble the CLAMP ASSEMBLY.



⑥ Lift and tilt the cabinet cover.



⑦ Disconnect the main PCB connector.

※ NOTE : When assembling the CABINET COVER, connect the door switch connector.

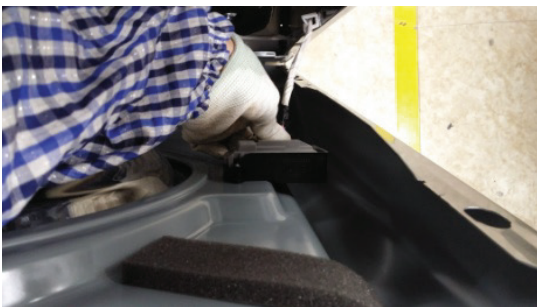

⑧ Disconnect the door switch connector.



⑨ Lift and separate the cabinet cover.

DOOR



- ① Unscrew the screw from back of the cabinet cover.



- ② Unscrew the 4 hexagon head screws from the cabinet cover.
- ③ Disassemble the door upward.

DOOR LOCK SWITCH ASSEMBLY



- ① Open the door and disassemble the CLAMP ASSEMBLY.



- ② Unscrew the 2 screws.

※ NOTE

- Reconnect the connector after replacing the DOOR SWITCH ASSEMBLY.

PUMP



- ① Disassemble the cabinet cover.
- ② Separate the pump hose, the bellows, the circulation hoses from the pump assembly.

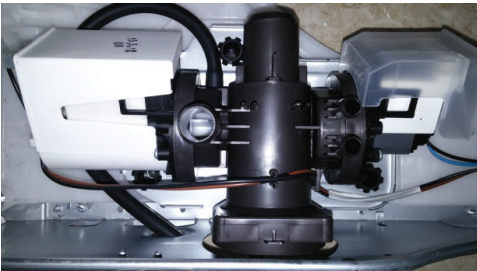

- ③ Remove the 3 bolts from the pump assembly.
- ④ Disassemble the pump assembly.

HEATER

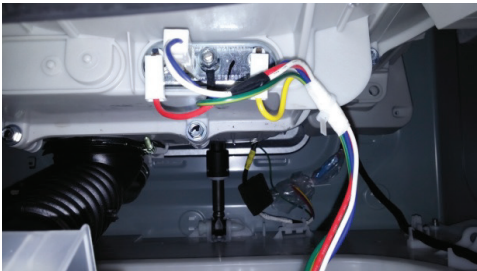

- ① Disassemble the cabinet cover.
- ② Separate 3 connectors from the heater and loosen the nut.



- ④ Loosen the nut and pull out the heater.

※ CAUTION

- When assembling the heater, insert the heater into the heater clip on the bottom of the tub.
- Tighten the fastening nut so the heater is secure.

WHEN FOREIGN OBJECT IS STUCK BETWEEN DRUM AND TUB



- ① Disassemble the cabinet cover.
- ② Separate the heater from the tub.
- ③ Remove any foreign objects(wire, coin etc.) by inserting a long bar in the opening.

LAMP ASSEMBLY



- ① Disassemble the top plate.
- ② Disassemble the cabinet cover.
- ③ Disconnect the connector.

MOTOR



- ① Unscrew 4 screws from the back cover.
- ② Disassemble the back cover.



- ③ Remove the bolt.
- ④ Pull out the rotor.

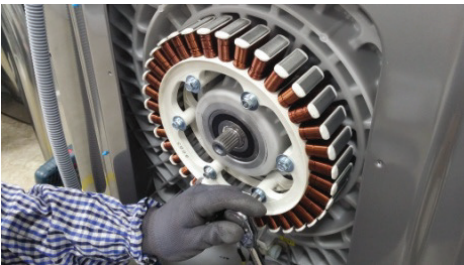

- ⑤ Remove the 6 bolts on the stator.

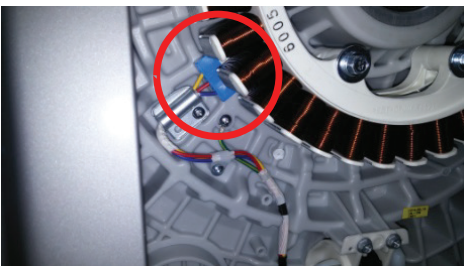

- ⑥ Unplug the connector from the stator.

DAMPER

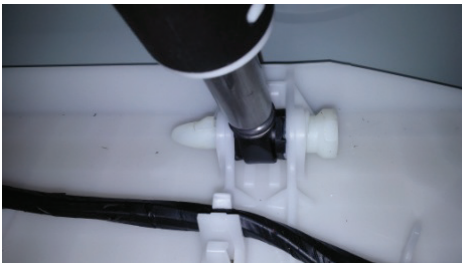

- ① Disassemble the damper hinges from the tub and base.

※ NOTE

- When replacing dampers, replace them as a set rather than individually. There are several iterations of dampers available. Be sure all three in the set are the same class.

11. EXPLODED VIEW

11-1. CABINET & CONTROL PANEL ASSEMBLY

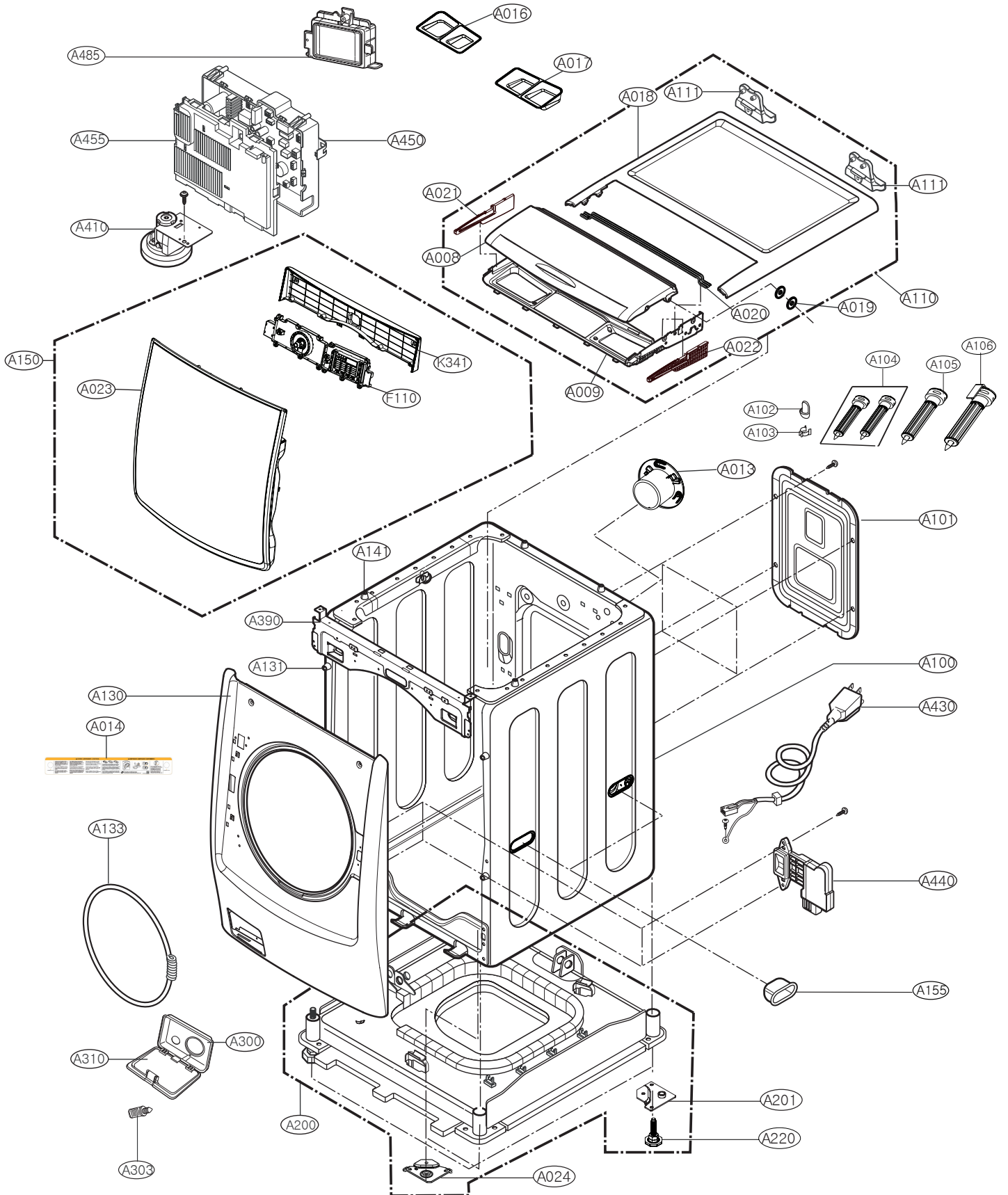

11-2. DRUM & TUB ASSEMBLY

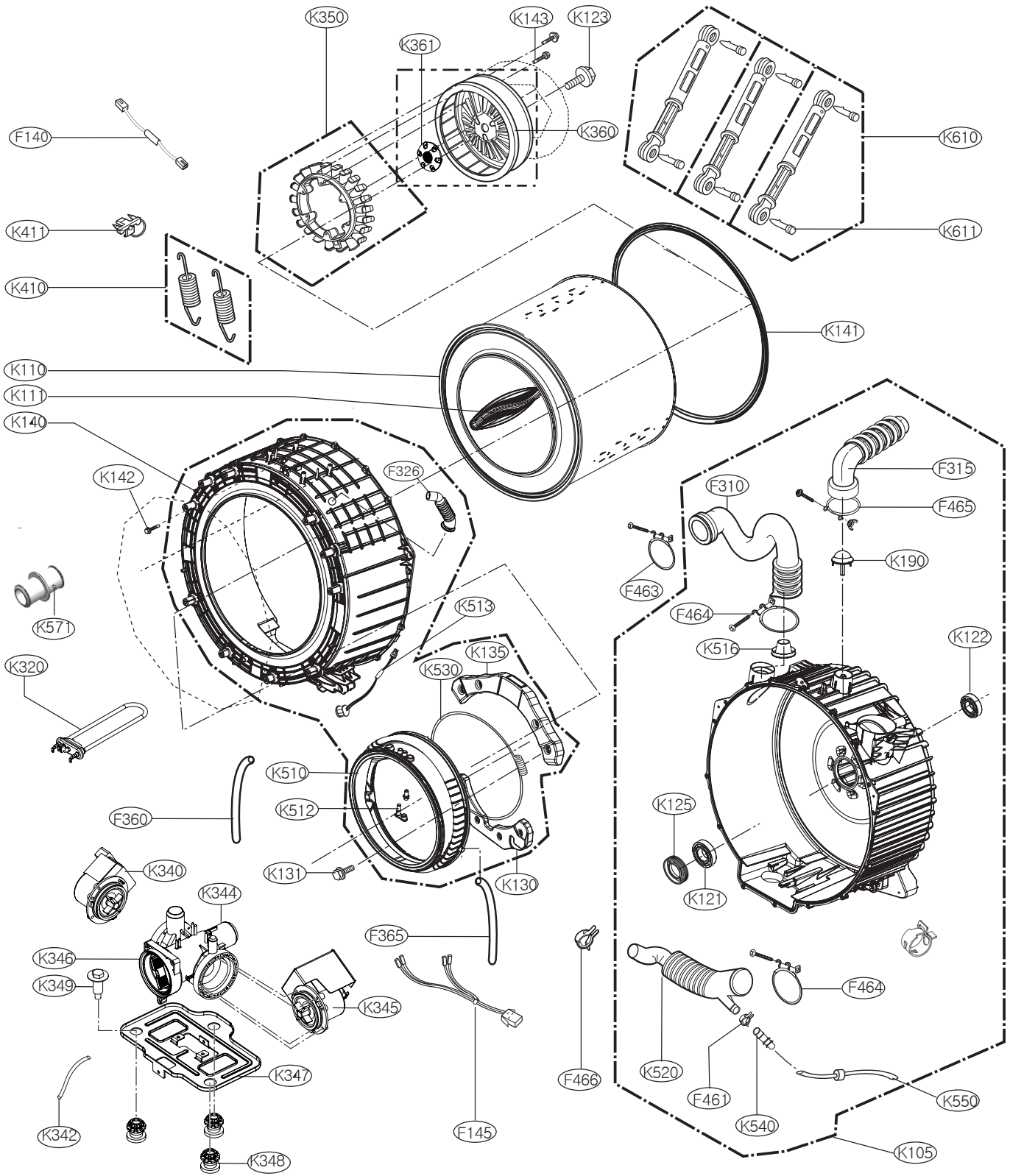

- ※ In case of replacing THERMISTOR of HEATER ASSEMBLY(K320), replace HEATER ASSEMBLY(K320), HEATER ASSEMBLY(K320) includes THERMISTOR.
- ※ In case of replacing BEARING,BALL(K121,K122) and GASKET(K125), replace TUB ASSEMBLY,OUTER(K105), TUB ASSEMBLY,OUTER(K105) includes BEARING,BALL(K121,K122) and GASKET(K125).
- ※ Part Assembly(K142) includes 10 screws.

11-3. DISPENSER ASSEMBLY

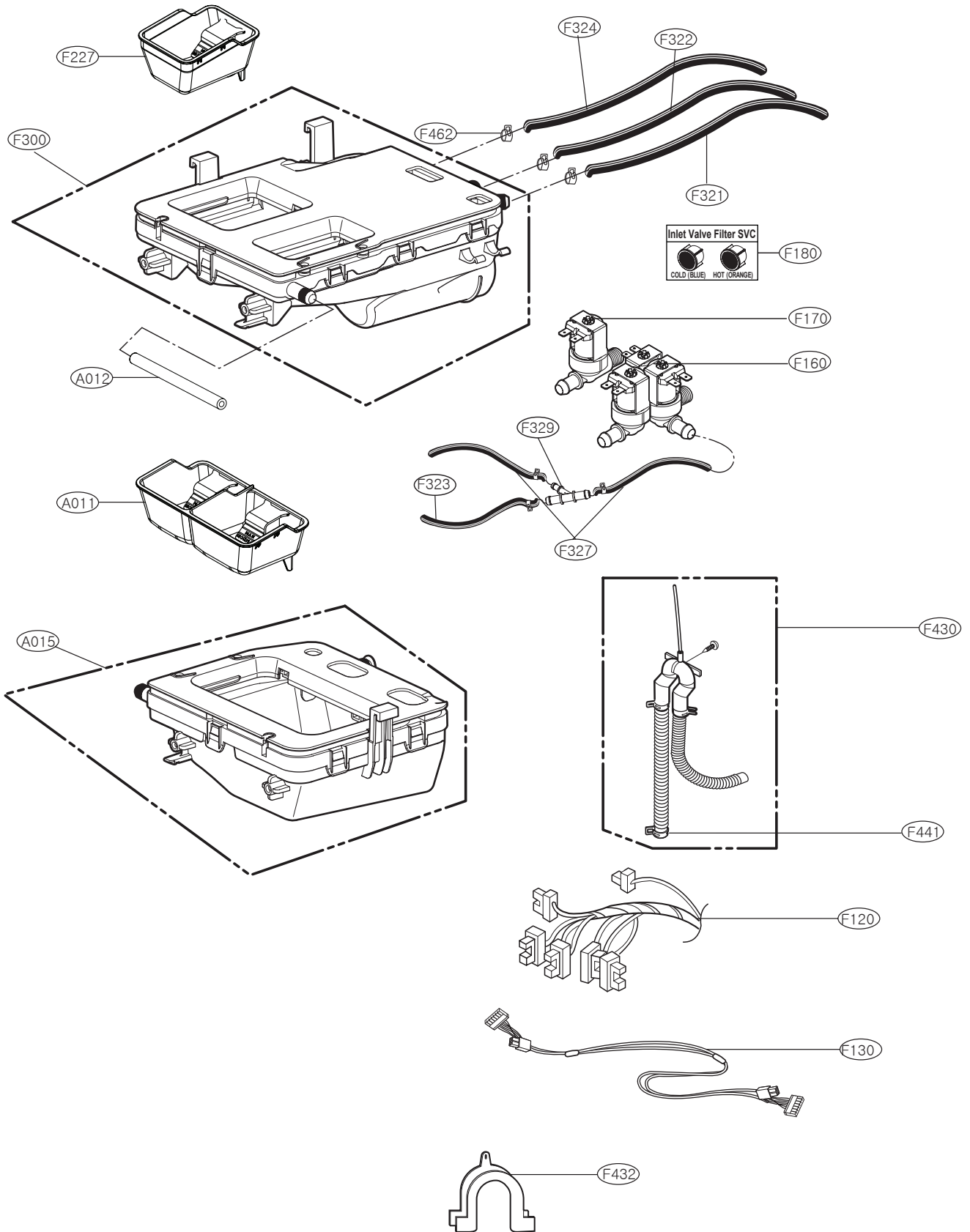



MAR, 2016 PRINTED IN KOREA

P/No.: MFL68840010